

400W Surface Mount Transient Voltage Suppressors - 6.8V-440V

Features

- 400W peak pulse power capability with a 10/1000us waveform, repetition rate (duty cycle): 0.01%.
- Excellent clamping capability.
- Low incremental surge resistance.
- Fast response time from 0V to V_{BR} , typically less than 1 pS for uni-directional & 5 nS for bi-directional types.
- Ultra high-speed switching.
- Glass passivated chip junction.
- Lead-free parts meet environmental standards of MIL-STD-19500 / 228
- Compliant to Halogen-free

Mechanical data

- Epoxy:UL94-V0 rated flame retardant
- Case : Molded plastic, DO-214AC / SMA
- Terminals : Solder plated, solderable per MIL-STD-750, Method 2026
- Polarity : Indicated by cathode band
- Mounting Position : Any
- Weight : Approximated 0.05 gram

Package outline

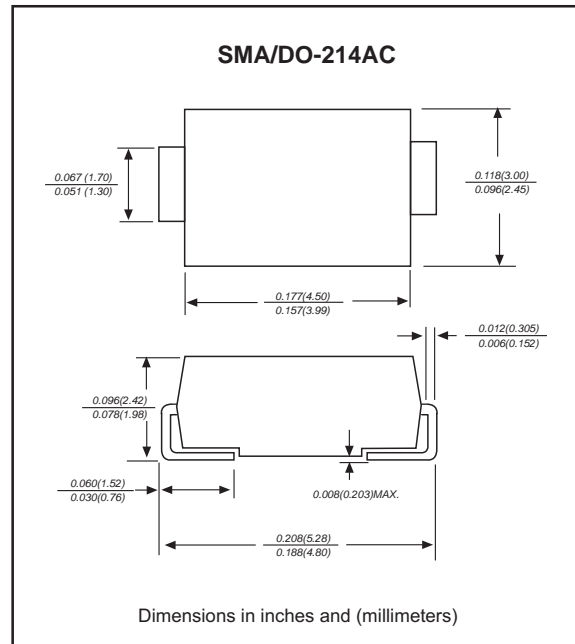

Maximum ratings (AT $T_A=25^\circ\text{C}$ unless otherwise noted)

PARAMETER	CONDITIONS	Symbol	MIN.	TYP.	MAX.	UNIT
Peak power dissipation	with a 10/1000us waveform, Note 1 & Fig. 1	P_{PPM}			400	W
Peak pulse current	with a 10/1000us waveform	I_{PPM}	See table 1			A
Steady state power dissipation	at $T_L=75^\circ\text{C}$ lead length 0.375" (9.5 mm)	$P_{M(AV)}$			1.0	W
Peak forward surge current	8.3ms single half sine-wave superimposed on rated load (jedec method), note 2	I_{FSM}			40	A
Maximum instantaneous forward voltage	for uni-directional types only, at 25A, see note 3	V_F			3.5/5.0	V
Operating temperature		T_J	-55		+150	$^\circ\text{C}$
Storage temperature		T_{STG}	-65		+175	$^\circ\text{C}$

Note 1. Non-repetitive current pulse, per Fig. 3 and derated above $T_A=25^\circ\text{C}$ per Fig. 2

2. Measured on 8.3 ms single half sine-wave or equivalent square wave, duty cycle=4 pulses per minute maximum

3. $V_F=3.5\text{V}$ max. for devices of $V_{BR}<200\text{V}$, and $V_F=5.0\text{V}$ max. for devices of $V_{BR}>201\text{V}$

Electrical characteristics (at T =25°C unless otherwise noted)

Type Number		Marking		Reverse Stand-Off Voltage	Breakdown Voltage Min. @I _T	Breakdown Voltage Max. @ I _T	Test Current	Maximum Clamping Voltage @I _{PP}	Peak Pulse Current	Reverse Leakage @V _{RMW}
(Uni)	(Bi)	(Uni)	(Bi)	V _{RMW} (V)	V _{BR MIN} (V)	V _{BR MAX} (V)	I _T (mA)	V _C (V)	I _{PP} (A)	I _R (uA)
P4SMA6.8	P4SMA6.8C	6V8	6V8C	5.50	6.12	7.48	10	10.8	38.0	1000.0
P4SMA6.8A	P4SMA6.8CA	6V8A	6V8CA	5.80	6.45	7.14	10	10.5	40.0	1000.0
P4SMA7.5	P4SMA7.5C	7V5	7V5C	6.05	6.75	8.25	10	11.7	36.0	500.0
P4SMA7.5A	P4SMA7.5CA	7V5A	7V5CA	6.40	7.13	7.88	10	11.3	37.0	500.0
P4SMA8.2	P4SMA8.2C	8V2	8V2C	6.63	7.38	9.02	10	12.5	33.0	200.0
P4SMA8.2A	P4SMA8.2CA	8V2A	8V2CA	7.02	7.79	8.61	10	12.1	35.0	200.0
P4SMA9.1	P4SMA9.1C	9V1	9V1C	7.37	8.19	10.0	1.0	13.8	30.0	50.0
P4SMA9.1A	P4SMA9.1CA	9V1A	9V1CA	7.78	8.65	9.55	1.0	13.4	31.0	50.0
P4SMA10	P4SMA10C	10	10C	8.10	9.00	11.0	1.0	15.0	28.0	10.0
P4SMA10A	P4SMA10CA	10A	10CA	8.55	9.50	10.5	1.0	14.5	29.0	10.0
P4SMA11	P4SMA11C	11	11C	8.92	9.90	12.1	1.0	16.2	26.0	5.0
P4SMA11A	P4SMA11CA	11A	11CA	9.40	10.5	11.6	1.0	15.6	27.0	5.0
P4SMA12	P4SMA12C	12	12C	9.72	10.8	13.2	1.0	17.3	24.0	5.0
P4SMA12A	P4SMA12CA	12A	12CA	10.2	11.4	12.6	1.0	16.7	25.0	5.0
P4SMA13	P4SMA13C	13	13C	10.5	11.7	14.3	1.0	19.0	22.0	5.0
P4SMA13A	P4SMA13CA	13A	13CA	11.1	12.4	13.7	1.0	18.2	23.0	5.0
P4SMA15	P4SMA15C	15	15C	12.1	13.5	16.5	1.0	22.0	19.0	5.0
P4SMA15A	P4SMA15CA	15A	15CA	12.8	14.3	15.8	1.0	21.2	20.0	5.0
P4SMA16	P4SMA16C	16	16C	12.9	14.4	17.6	1.0	23.5	18.0	5.0
P4SMA16A	P4SMA16CA	16A	16CA	13.6	15.2	16.8	1.0	22.5	19.0	5.0
P4SMA18	P4SMA18C	18	18C	14.5	16.2	19.8	1.0	26.5	16.0	5.0
P4SMA18A	P4SMA18CA	18A	18CA	15.3	17.1	18.9	1.0	25.2	17.0	5.0
P4SMA20	P4SMA20C	20	20C	16.2	18.0	22.0	1.0	29.1	14.0	5.0
P4SMA20A	P4SMA20CA	20A	20CA	17.1	19.0	21.0	1.0	27.7	15.0	5.0
P4SMA22	P4SMA22C	22	22C	17.8	19.8	24.2	1.0	31.9	13.0	5.0
P4SMA22A	P4SMA22CA	22A	22CA	18.8	20.9	23.1	1.0	30.6	14.0	5.0
P4SMA24	P4SMA24C	24	24C	19.4	21.6	26.4	1.0	34.7	12.0	5.0
P4SMA24A	P4SMA24CA	24A	24CA	20.5	22.8	25.2	1.0	33.2	13.0	5.0
P4SMA27	P4SMA27C	27	27C	21.8	24.3	29.7	1.0	39.1	11.0	5.0
P4SMA27A	P4SMA27CA	27A	27CA	23.1	25.7	28.4	1.0	37.5	11.2	5.0
P4SMA30	P4SMA30C	30	30C	24.3	27.0	33.0	1.0	43.5	10.0	5.0
P4SMA30A	P4SMA30CA	30A	30CA	25.6	28.5	31.5	1.0	41.4	10.0	5.0
P4SMA33	P4SMA33C	33	33C	26.8	29.7	36.3	1.0	47.7	9.0	5.0
P4SMA33A	P4SMA33CA	33A	33CA	28.2	31.4	34.7	1.0	45.7	9.0	5.0
P4SMA36	P4SMA36C	36	36C	29.1	32.4	39.6	1.0	52.0	8.0	5.0
P4SMA36A	P4SMA36CA	36A	36CA	30.8	34.2	37.8	1.0	49.9	8.4	5.0

※ For Bi-directional type having VRWM of 10 Volts and less, the IR limit is double

Electrical characteristics (at T =25°C unless otherwise noted)

Type Number		Marking		Reverse Stand-Off Voltage	Breakdown Voltage Min. @I _T	Breakdown Voltage Max. @ I _T	Test Current	Maximum Clamping Voltage @I _{PP}	Peak Pulse Current	Reverse Leakage @V _{RMW}
(Uni)	(Bi)	(Uni)	(Bi)	V _{RMW} (V)	V _{BR MIN} (V)	V _{BR MAX} (V)	I _T (mA)	V _C (V)	I _{PP} (A)	I _R (uA)
P4SMA39	P4SMA39C	39	39C	31.6	35.1	42.9	1.0	56.4	7.4	5.0
P4SMA39A	P4SMA39CA	39A	39CA	33.3	37.1	41.0	1.0	53.9	7.8	5.0
P4SMA43	P4SMA43C	43	43C	34.8	38.7	47.3	1.0	61.9	6.8	5.0
P4SMA43A	P4SMA43CA	43A	43CA	36.8	40.9	45.2	1.0	59.3	7.1	5.0
P4SMA47	P4SMA47C	47	47C	38.1	42.3	51.7	1.0	67.8	6.2	5.0
P4SMA47A	P4SMA47CA	47A	47CA	40.2	44.7	49.4	1.0	64.8	5.0	5.0
P4SMA51	P4SMA51C	51	51C	41.3	45.9	56.1	1.0	73.5	5.7	5.0
P4SMA51A	P4SMA51CA	51A	51CA	43.6	48.5	53.6	1.0	70.1	6.0	5.0
P4SMA56	P4SMA56C	56	56C	45.4	50.4	61.6	1.0	80.5	5.2	5.0
P4SMA56A	P4SMA56CA	56A	56CA	47.8	53.2	58.8	1.0	77.0	5.5	5.0
P4SMA62	P4SMA62C	62	62C	50.2	55.8	68.2	1.0	89.0	4.7	5.0
P4SMA62A	P4SMA62CA	62A	62CA	53.0	58.9	65.1	1.0	85.0	5.0	5.0
P4SMA68	P4SMA68C	68	68C	55.1	61.2	74.8	1.0	98.0	4.3	5.0
P4SMA68A	P4SMA68CA	68A	68CA	58.1	64.6	71.4	1.0	92.0	4.6	5.0
P4SMA75	P4SMA75C	75	75C	60.7	67.5	82.5	1.0	108	3.9	5.0
P4SMA75A	P4SMA75CA	75A	75CA	64.1	71.3	78.8	1.0	103	4.1	5.0
P4SMA82	P4SMA82C	82	82C	66.4	73.8	90.2	1.0	118	3.6	5.0
P4SMA82A	P4SMA82CA	82A	82CA	70.1	77.9	86.1	1.0	113	3.7	5.0
P4SMA91	P4SMA91C	91	91C	73.7	81.9	100	1.0	131	3.2	5.0
P4SMA91A	P4SMA91CA	91A	91CA	77.8	86.5	95.5	1.0	125	3.4	5.0
P4SMA100	P4SMA100C	100	100C	81.0	90.0	110	1.0	144	2.9	5.0
P4SMA100A	P4SMA100CA	100A	100CA	85.5	95.0	105	1.0	137	3.1	5.0
P4SMA110	P4SMA110C	110	110C	89.2	99.0	121	1.0	158	2.7	5.0
P4SMA110A	P4SMA110CA	110A	110CA	94.0	105	116	1.0	152	2.8	5.0
P4SMA120	P4SMA120C	120	120C	97.2	108	132	1.0	173	2.4	5.0
P4SMA120A	P4SMA120CA	120A	120CA	102	114	126	1.0	165	2.5	5.0
P4SMA130	P4SMA130C	130	130C	105	117	143	1.0	187	2.2	5.0
P4SMA130A	P4SMA130CA	130A	130CA	111	124	137	1.0	179	2.3	5.0
P4SMA150	P4SMA150C	150	150C	121	135	165	1.0	215	2.0	5.0
P4SMA150A	P4SMA150CA	150A	150CA	128	143	158	1.0	207	2.0	5.0
P4SMA160	P4SMA160C	160	160C	130	144	176	1.0	230	1.8	5.0
P4SMA160A	P4SMA160CA	160A	160CA	136	152	168	1.0	219	1.9	5.0

※ For Bi-directional type having VRWM of 10 Volts and less, the IR limit is double

Electrical characteristics (at T =25°C unless otherwise noted)

Type Number		Marking		Reverse Stand-Off Voltage	Breakdown Voltage Min. @I _T	Breakdown Voltage Max. @ I _T	Test Current	Maximum Clamping Voltage @I _{PP}	Peak Pulse Current	Reverse Leakage @V _{RMW}
(Uni)	(Bi)	(Uni)	(Bi)	V _{RMW} (V)	V _{BR MIN} (V)	V _{BR MAX} (V)	I _T (mA)	V _C (V)	I _{PP} (A)	I _R (uA)
P4SMA170	P4SMA170C	170	170C	138	153	187	1.0	244	1.7	5.0
P4SMA170A	P4SMA170CA	170A	170CA	145	162	179	1.0	234	1.8	5.0
P4SMA180	P4SMA180C	180	180C	146	162	198	1.0	258	1.6	5.0
P4SMA180A	P4SMA180CA	180A	180CA	154	171	189	1.0	246	1.7	5.0
P4SMA200	P4SMA200C	200	200C	162	180	220	1.0	287	1.5	5.0
P4SMA200A	P4SMA200CA	200A	200CA	171	190	210	1.0	274	1.53	5.0
P4SMA220	P4SMA220C	220	220C	175	198	242	1.0	344	1.16	5.0
P4SMA220A	P4SMA220CA	220A	220CA	185	209	231	1.0	328	1.22	5.0
P4SMA250	P4SMA250C	250	250C	202	225	275	1.0	360	1.1	5.0
P4SMA250A	P4SMA250CA	250A	250CA	214	237	263	1.0	344	1.16	5.0
P4SMA300	P4SMA300C	300	300C	243	270	330	1.0	430	0.93	5.0
P4SMA300A	P4SMA300CA	300A	300CA	256	285	315	1.0	414	0.97	5.0
P4SMA350	P4SMA350C	350	350C	284	315	385	1.0	504	0.79	5.0
P4SMA350A	P4SMA350CA	350A	350CA	300	333	368	1.0	482	0.83	5.0
P4SMA400	P4SMA400C	400	400C	324	360	440	1.0	574	0.70	5.0
P4SMA400A	P4SMA400CA	400A	400CA	342	380	420	1.0	548	0.73	5.0
P4SMA440	P4SMA440C	440	440C	356	396	484	1.0	631	0.63	5.0
P4SMA440A	P4SMA440CA	440A	440CA	376	418	462	1.0	602	0.65	5.0

※ For Bi-directional type having VRWM of 10 Volts and less, the IR limit is double

Rating and characteristic curves (P4SMA SERIES)

Fig.1 - PEAK PULSE POWER RATING CURVE

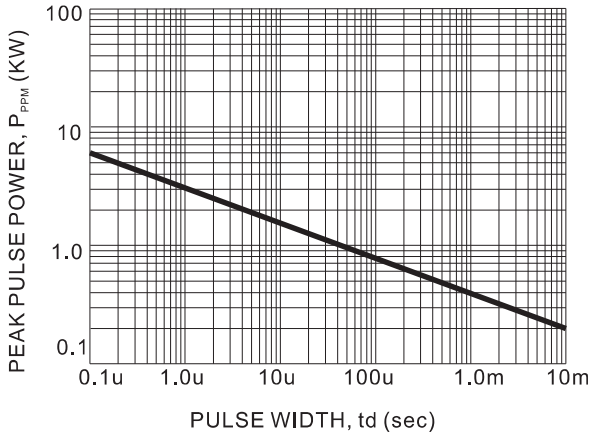

Fig.2 - PULSE DERATING CURVE

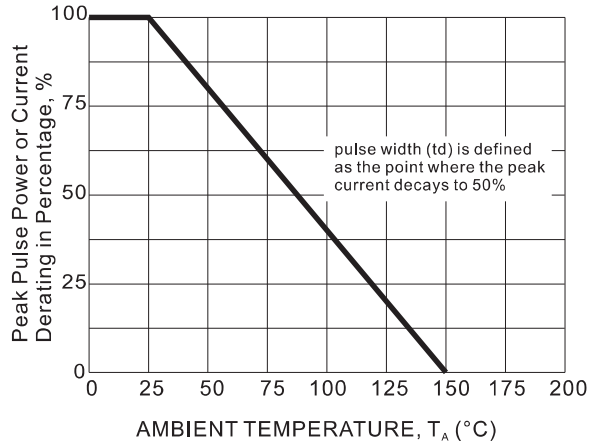

Fig.3 - Pulse Waveform

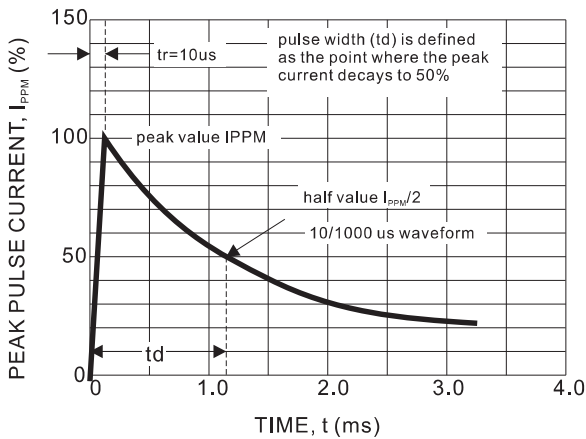

Fig.4 - Typical Junction Capacitance

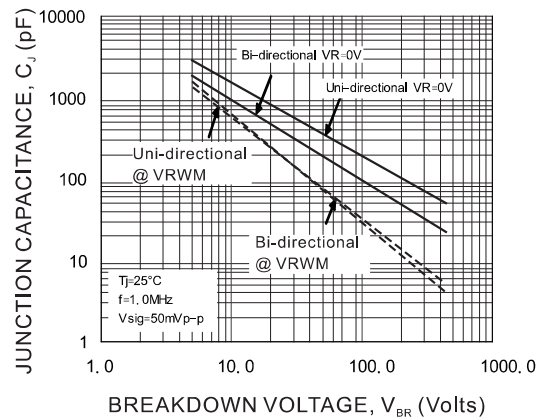

Fig.5 - STEADY STATE POWER DERATING CURVE

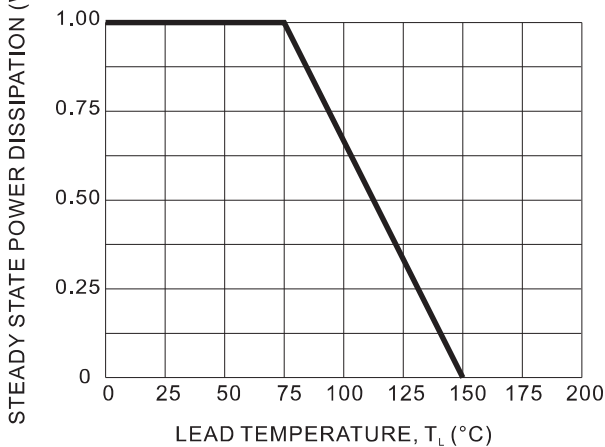
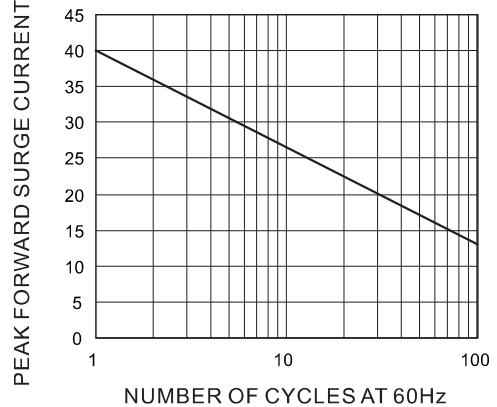







Fig.6 - MAXIMUM NON-REPETITIVE FORWARD SURGE CURRENT



Pinning information

Pin	Simplified outline	Symbol
Uni-Directional Pin1 cathode Pin2 anode		
Bi-Directional		

Marking

Type number	Example
Uni-Directional	 <p>Cathode band</p> <p>Marking code (see page 3 to page 5)</p>
Bi-Directional	 <p>Marking code (see page 3 to page 5)</p>

Suggested solder pad layout

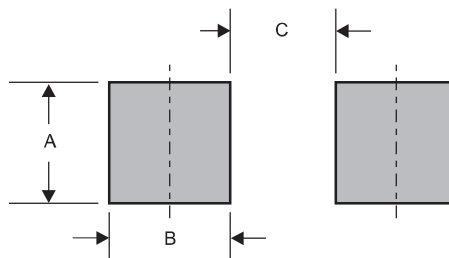

Dimensions in inches and (millimeters)

PACKAGE	A	B	C
SMA	0.063 (1.60)	0.059 (1.50)	0.110 (2.80)