

Data sheet

Title: FIXED THIN FILM CHIP RESISTORS;
RECTANGULAR TYPE

Style: RNC06, 20, 32

RoHS COMPLIANCE ITEM

Halogen and Antimony Free

- Note:
- Stock conditions
Temperature: +5°C ~ +35°C
Relative humidity: 25% ~ 75%
The period of guarantee: Within 2 year from shipment by the company.
Solderability shall be satisfied.
 - Product specification contained in this data sheet are subject to change at any time without notice
 - If you have any questions or a Purchasing Specification for any quality Agreement is necessary, please contact our sales staff.



釜屋電機株式會社
KAMAYA ELECTRIC CO., LTD.

Hokkaido Research Center
Approval by: T. Sannomiya
Drawing by: M. Shibuya

1. Scope

1.1 This specification covers the detail requirements for fixed thin film chip resistors; rectangular type & precision, style of RNC06, 20, 32.

1.2 Applicable documents

JIS C 5201-1:2011, JIS C 5201-8: 2014, JIS C 5201-8-1: 2014
IEC60115-1: 2008, IEC60115-8: 2009, IEC60115-8-1: 2014
EIAJ RC-2133C-2010

2. Classification

Type designation shall be the following form.

(Example)

| | | | | | |
|-----|----|---|------|---|----|
| RNC | 32 | E | 1002 | B | TP |
| 1 | 2 | 3 | 4 | 5 | 6 |

Style

1 Fixed thin film chip resistors; rectangular type  Style

2 Size

3 Temperature coefficient of resistance

| | |
|---|------------------------------------------|
| E | $\pm 25 \times 10^{-6} / ^\circ\text{C}$ |
| C | $\pm 50 \times 10^{-6} / ^\circ\text{C}$ |

4 Rated resistance Example; 1002 \rightarrow 10k Ω

| | |
|------|-----------------------------------------------------------------------------------------------|
| 103 | E24 Series, 3 digit, Ex. 103 \rightarrow 10k Ω , |
| 1002 | E96 Series, 4 digit, Ex. 1002 \rightarrow 10k Ω 10R2 \rightarrow 10.2k Ω |

5 Tolerance on rated resistance

| | |
|---|--------------|
| B | $\pm 0.1\%$ |
| C | $\pm 0.25\%$ |
| D | $\pm 0.5\%$ |
| F | $\pm 1\%$ |

6 Packaging form

| | |
|----|----------------------|
| B | Bulk (loose package) |
| PA | Press pocket taping |
| TP | Paper taping |

3. Rating

3.1 The ratings shall be in accordance with Table-1.

Table-1

| Style | Rated dissipation (W) | Temperature coefficient of resistance ($10^{-6}/^{\circ}\text{C}$) | Rated resistance range(Ω) | Preferred number series for resistors | Tolerance on rated resistance |
|-------|-----------------------|----------------------------------------------------------------------|------------------------------------|---------------------------------------|---------------------------------|
| RNC06 | 0.05 | E: ± 25 | 100~12k | E24,96 | B($\pm 0.1\%$) |
| | | C: ± 50 | | | |
| | | E: ± 25 | 27~12k | | D($\pm 0.5\%$),F($\pm 1\%$) |
| | | C: ± 50 | 27~22.1k | | |
| RNC20 | 0.1 | E: ± 25 | 100~130k | | B($\pm 0.1\%$) |
| | | | 10~130k | | |
| RNC32 | 0.125 | | 100~180k | | B($\pm 0.1\%$) |
| | | | 10~180k | | |

| Style | Limiting element voltage (V) | Insulation Voltage (V) | Category temperature range($^{\circ}\text{C}$) |
|-------|------------------------------|------------------------|--------------------------------------------------|
| RNC06 | 15 | 50 | -55~+155 |
| RNC20 | 100 | 100 | |
| RNC32 | 200 | | |

3.2 Climatic category

55/155/56

Lower category temperature -55 $^{\circ}\text{C}$
 Upper category temperature +155 $^{\circ}\text{C}$
 Duration of the damp heat, steady state test 56days

3.3 Stability class

1%

Limits for change of resistance:

- for long - term tests $\pm(1.0\%+0.05\Omega)$
 - for short - term tests $\pm(0.25\%+0.05\Omega)$

3.4 Derating

The derated values of dissipation at temperature in excess of 70 $^{\circ}\text{C}$ shall be as indicated by the following curve.

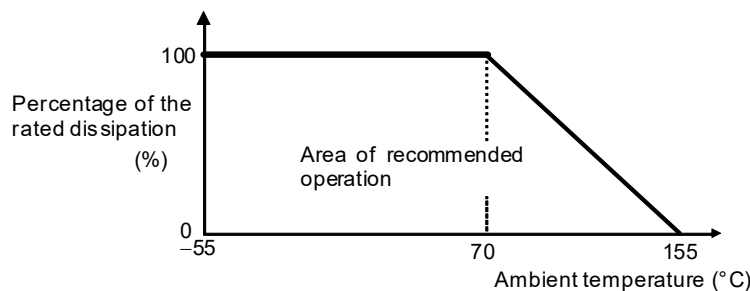

Figure-1 Derating curve

3.5 Rated voltage

d.c.or a.c.r.m.s.voltage calculated from the square root of the product of the rated resistance and the rated dissipation.

$$E = \sqrt{P \cdot R}$$

E: Rated voltage (V)

P: Rated dissipation (W)

R: Rated resistance (Ω)

Limiting element voltage can only be applied to resistors when the resistance value is equal to or higher than the critical resistance value.

At high value of resistance, the rated voltage may not be applicable.

4. Packaging form

The standard packaging form shall be in accordance with Table-2.

Table-2

| Symbol | Packaging form | | Standard packaging quantity / units | Application |
|--------|------------------------------------|------------------------|-------------------------------------|---------------|
| B | Bulk (loose package) | | 1,000 pcs. | RNC06, 20, 32 |
| PA | Press pocket taping (paper taping) | 8mm width, 2mm pitches | 15,000 pcs. | RNC06 |
| TP | Paper taping | 8mm width, 4mm pitches | 5,000 pcs. | RNC20, 32 |

5. Dimensions

5.1 The resistor shall be of the design and physical dimensions in accordance with Figure-2 and Table-3.

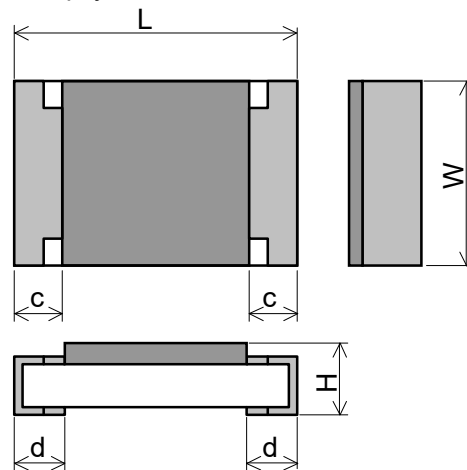

Figure-2

Table-3

| Style | L | W | H | c | d | Unit: mm |
|-------|----------|----------------------------------------|-----------|-----------|-------------------------------------|----------|
| RNC06 | 0.6±0.03 | 0.3±0.03 | 0.23±0.03 | 0.1±0.05 | 0.15±0.05 | |
| RNC20 | 2.0±0.15 | 1.25 ^{+0.10} _{-0.05} | 0.6±0.1 | 0.4±0.2 | 0.3 ^{+0.2} _{-0.1} | |
| RNC32 | 3.1±0.1 | 1.55 ^{+0.10} _{-0.05} | 0.6±0.1 | 0.45±0.20 | 0.3 ^{+0.2} _{-0.1} | |

5.2 Net weight (Reference)

| Style | Net weight(mg) |
|-------|----------------|
| RNC06 | 0.16 |
| RNC20 | 5 |
| RNC32 | 9 |

6. Marking

The Rated resistance shall be marked in 3 digits (E24) or 4 digits (E96) and marked on over coat side.

- E24 series: 3 digits, E96 series: 4 digits

In case of the resistance value that E96 overlaps with E24, It is marked by either.

The Rated resistance of RNC06 should not be marked.

| Marking example | Contents | Application |
|-----------------|------------------------------------------------------|----------------------------------------|
| 123 | $12 \times 10^3 [\Omega] \rightarrow 12 [k\Omega]$ | RNC20,32 |
| 12R7 | 12.7 $[\Omega]$ | E96, Less than 100Ω of RNC20,32 |
| 5623 | $562 \times 10^3 [\Omega] \rightarrow 562 [k\Omega]$ | RNC20,32 |

7. Performance

7.1 The standard condition for tests shall be in accordance with Sub-clause 4.2, JIS C 5201-1: 2011.

7.2 The performance shall be satisfied in Table-4.

Table-4(1)

| No. | Test items | Condition of test (JIS C 5201-1) | Performance requirements |
|-----|-------------------------|---------------------------------------------------------------------------------------------------------------------------------------------------------------------------------------------------------------------------------------------------------------------------|-------------------------------------------------------------------------------------------------------------------------------------------------------------------------------|
| 1 | Visual examination | Sub-clause 4.4.1 Checked by visual examination. | As in 4.4.1 The marking shall be legible, as checked by visual examination. |
| 2 | Dimension Resistance | Sub-clause 4.4.2 Sub-clause 4.5 | As specified in Table-3 of this specification. As in 4.5.2 The resistance value shall correspond with the rated resistance taking into account the specified tolerance. |
| 3 | Voltage proof | Sub-clause 4.7 Method: 4.6.1.4(See Figure-3) Test voltage: Alternating voltage with a peak value of 1.42 times the insulation voltage. Duration: $60 \text{ s} \pm 5 \text{ s}$ Insulation resistance Test voltage: Insulation voltage Duration: 1 min. | No breakdown or flash over $R \geq 1 \text{ G}\Omega$ |
| 4 | Solderability | Sub-clause 4.17 Without ageing Flux: The resistors shall be immersed in a non-activated soldering flux for 2s. Bath temperature: $235 \text{ }^\circ\text{C} \pm 5 \text{ }^\circ\text{C}$ Immersion time: $2 \text{ s} \pm 0.5 \text{ s}$ | As in 4.17.4.5 The terminations shall be covered with a smooth and bright solder coating. |

Table-4(2)

| No | Test items | Condition of test (JIS C 5201-1) | Performance requirements |
|----|------------------------------------------------------------------------------------------------|-------------------------------------------------------------------------------------------------------------------------------------------------------------------------------------------------------------------------------------------------------------------------------------------------------------------------------------------------------------------------------------------------------------------------------|------------------------------------------------------------------------------------------------------------------------------------------------------------------------|
| 5 | Mounting Overload (in the mounted state) Solvent resistance of the marking | Sub-clause 4.31 Substrate material: Epoxide woven glass Sub-clause 4.13 The applied voltage shall be 2.5 times the rated voltage or twice the limiting element voltage, whichever is the less severe. Duration: 2 s Visual examination Resistance Sub-clause 4.30 Solvent: 2-propanol Solvent temperature: 23 °C ± 5 °C Method 1 Rubbing material: cotton wool Without recovery | No visible damage $\Delta R \leq \pm (0.25\% + 0.05\Omega)$ Legible marking |
| 6 | Mounting Bound strength of the end face plating Final measurements | Sub-clause 4.31 Substrate material: Epoxide woven glass Sub-clause 4.33 Bent value: 3 mm Resistance Sub-clause 4.33.6 Visual examination | $\Delta R \leq \pm (0.25\% + 0.05\Omega)$ No visible damage |
| 7 | Resistance to soldering heat Component solvent resistance | Sub-clause 4.18 Solder temperature: 260 °C ± 5 °C Immersion time: 10 s ± 0.5 s Visual examination Resistance Sub-clause 4.29 Solvent: 2-propanol Solvent temperature: 23 °C ± 5 °C Method 2 Recovery: 48 h Visual examination Resistance | As in 4.18.3.4 No sign of damage such as cracks. $\Delta R \leq \pm (0.25\% + 0.05\Omega)$ No visible damage $\Delta R \leq \pm (0.25\% + 0.05\Omega)$ |

Table-4(3)

| No | Test items | Condition of test (JIS C 5201-1) | Performance requirements |
|----|---------------------------------------------------------------------------------------------------------------------------------------------------------------------------------------------|----------------------------------------------------------------------------------------------------------------------------------------------------------------------------------------------------------------------------------------------------------------------------------------------------------------------------------------------------------------------------------------------------------------------------------------------------------------------------------------------------------------------------------------------------|--------------------------------------------------------------------------------------|
| 8 | Mounting Adhesion Rapid change temperature | Sub-clause 4.31 Substrate material: Epoxide woven glass Sub-clause 4.32 Force: 5 N (RNC06: 3N) Duration: 10 s ± 1 s Visual examination Sub-clause 4.19 Lower category temperature: -55 °C Upper category temperature: +155 °C Duration of exposure at each temperature: 30 min. Number of cycles: 5 cycles. Visual examination Resistance | No visible damage No visible damage $\Delta R \leq \pm(0.25\%+0.05\Omega)$ |
| 9 | Climatic sequence -Dry heat -Damp heat, cycle (12+12hour cycle) First cycle -Cold -Damp heat, cycle (12+12hour cycle) Remaining cycle -D.C. load | Sub-clause 4.23 Sub-clause 4.23.2 Test temperature: + 155 °C Duration: 16 h Sub-clause 4.23.3 Test method: 2 Test temperature: 55 °C [Severity(2)] Sub-clause 4.23.4 Test temperature -55 °C Duration: 2h Sub-clause 4.23.6 Test method: 2 Test temperature: 55 °C [Severity (2)] Number of cycles: 5 cycles Sub-clause 4.23.7 The applied voltage shall be the rated voltage or the limiting element voltage whichever is the smaller. Duration: 1 min. Visual examination Resistance | No visible damage $\Delta R \leq \pm (1\%+0.05\Omega)$ |
| 10 | Mounting Endurance at 70 °C | Sub-clause 4.31 Substrate material: Epoxide woven glass Sub-clause 4.25.1 Ambient temperature: 70 °C ± 2 °C Duration: 1000 h The voltage shall be applied in cycles of 1.5 h on and 0.5 h. The applied voltage shall be the rated voltage or the limiting element voltage whichever is the smaller. Examination at 48 h, 500 h and 1000 h: Visual examination Resistance | No visible damage $\Delta R \leq \pm (1\%+0.05\Omega)$ |

Table-4(4)

| No | Test items | Condition of test (JIS C 5201-1) | Performance requirements |
|----|------------------------------------------------------------------------------------|------------------------------------------------------------------------------------------------------------------------------------------------------------------------------------------------------------------------------------------------------------------------------------------------------------------------------------------------------------------------------------------------------------------------------------------------|------------------------------------------------------------------------------------|
| 11 | Mounting Variation of resistance with temperature | Sub-clause 4.31 Substrate material: Epoxide woven glass Sub-clause 4.8 +20 °C / +125°C | As in Table-1 |
| 12 | Mounting Damp heat, steady state | Sub-clause 4.31 Substrate material: Epoxide woven glass Sub-clause 4.24 Ambient temperature: 40 °C ± 2 °C Relative humidity : 93 \pm ₃ ² % a) 1st group: without voltage applied. b) 2nd group: The d.c.voltage shall be applied continuously. The voltage shall be accordance with Sub-clause 4.24.2.1 b). without polarizing voltage [4.24.2.1, c)] Visual examination Resistance | No visible damage Legible marking $\Delta R \leq \pm (1\%+0.05\Omega)$ |
| 13 | Dimensions (detail) Mounting Endurance at upper category temperature | Sub-clause 4.4.3 Sub-clause 4.31 Substrate material: Epoxide woven glass Sub-clause 4.25.3 Ambient temperature: 155 °C ± 2 °C Duration: 1000 h Examination at 48 h, 500 h and 1000 h: Visual examination Resistance | As in Table-3 No visible damage $\Delta R \leq \pm (1\%+0.05\Omega)$ |

* Voltage proof method

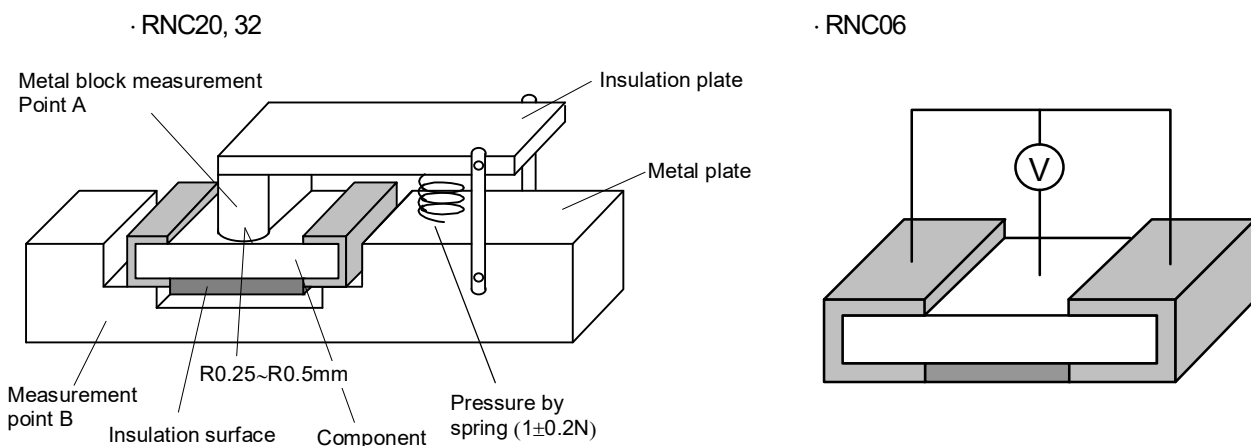

Figure-3

8. Taping

8.1 Applicable documents JIS C 0806-3: 2014, EIAJ ET-7200C: 2010

8.2 Taping dimensions

8.2.1 Press pocket taping (Paper taping, 8mm width, 2mm pitches)

Taping dimensions shall be in accordance with Figure-4 and Table-5.

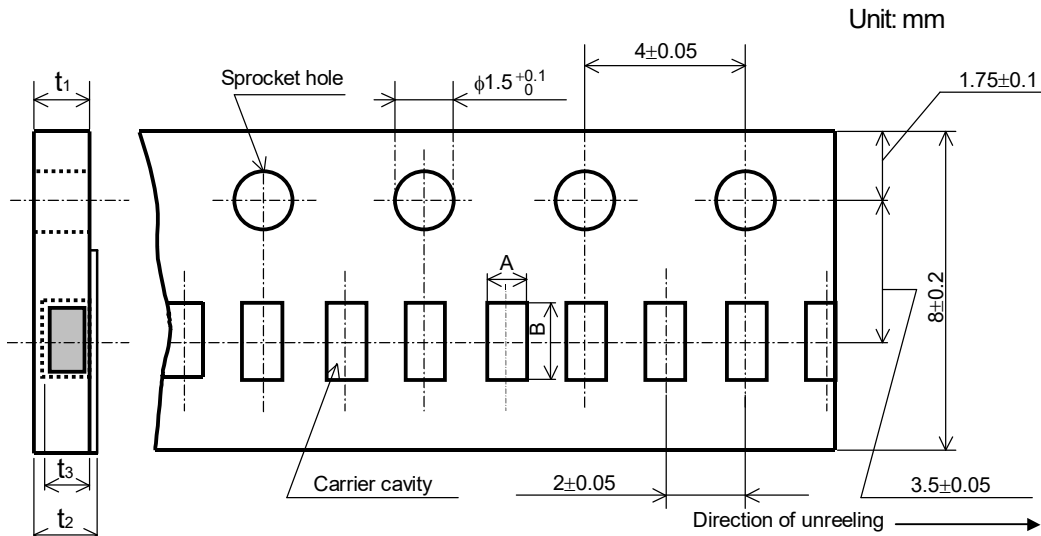

Figure-4

Table-5

| Style | A | B | t_1 | t_2 | t_3 |
|-------|-----------------|-----------------|-----------------|-----------------|-----------------|
| RNC06 | 0.37 ± 0.05 | 0.67 ± 0.05 | 0.42 ± 0.03 | 0.45 ± 0.05 | 0.27 ± 0.02 |

8.2.2 Paper taping (8mm width, 4mm pitches)

Taping dimensions shall be in accordance with Figure-5 and Table-6.

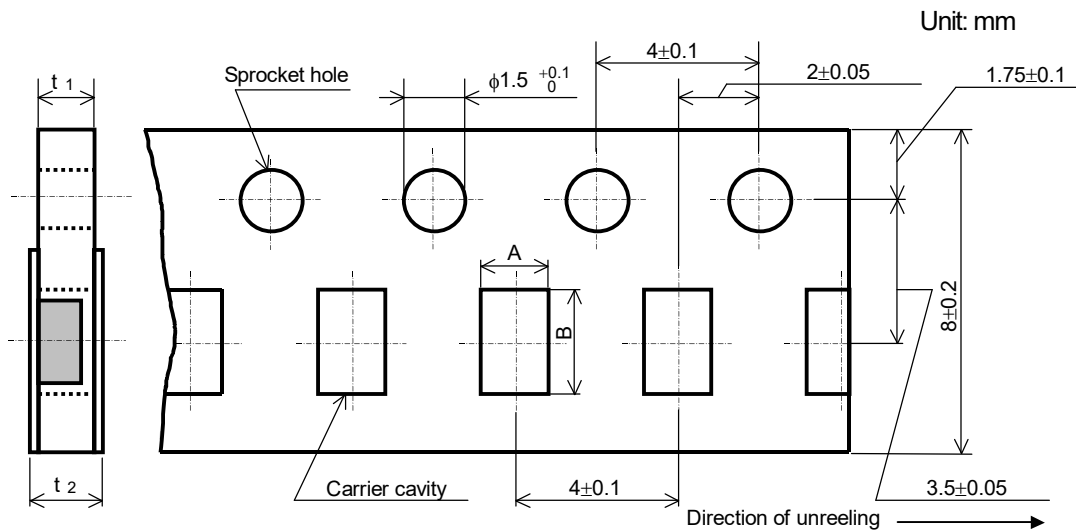

Figure-5

Table-6

| Style | A | B | t_1 | t_2 |
|-------|-----------------|---------------|---------------|---------|
| RNC20 | 1.65 ± 0.15 | 2.5 ± 0.2 | 0.8 ± 0.1 | 1.0max. |
| RNC32 | 2.00 ± 0.15 | 3.6 ± 0.2 | | |

- 1). The cover tapes shall not cover the sprocket holes.
- 2). Tapes in adjacent layers shall not stick together in the packing.
- 3). Components shall not stick to the carrier tape or to the cover tape.
- 4). Pitch tolerance over any 10 pitches $\pm 0.2\text{mm}$.
- 5). The peel strength of the top cover tape shall be within 0.1N to 0.5N on the test method as shown in the following RNC06: Figure-6, RNC20, 32: Figure-7.
- 6). When the tape is bent with the minimum radius for 25 mm, the tape shall not be damaged and the components shall maintain their position and orientation in the tape.
- 7). In no case shall there be two or more consecutive components missing.
The maximum number of missing components shall be one or 0.1%, whichever is greater.
- 8). The resistors shall be faced to upward at the over coating side in the carrier cavity.

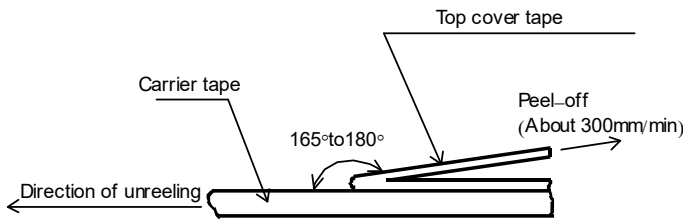

Figure-6

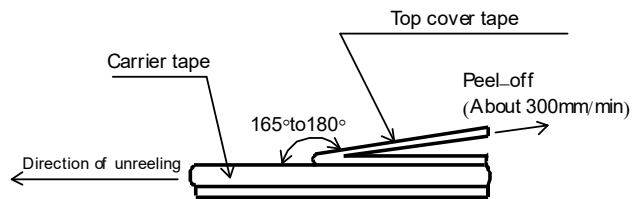

Figure-7

8.3 Reel dimension

Reel dimensions shall be in accordance with the following Figure-8 and Table-7.

Plastic reel (Based on EIAJ ET-7200C)

Unit: mm

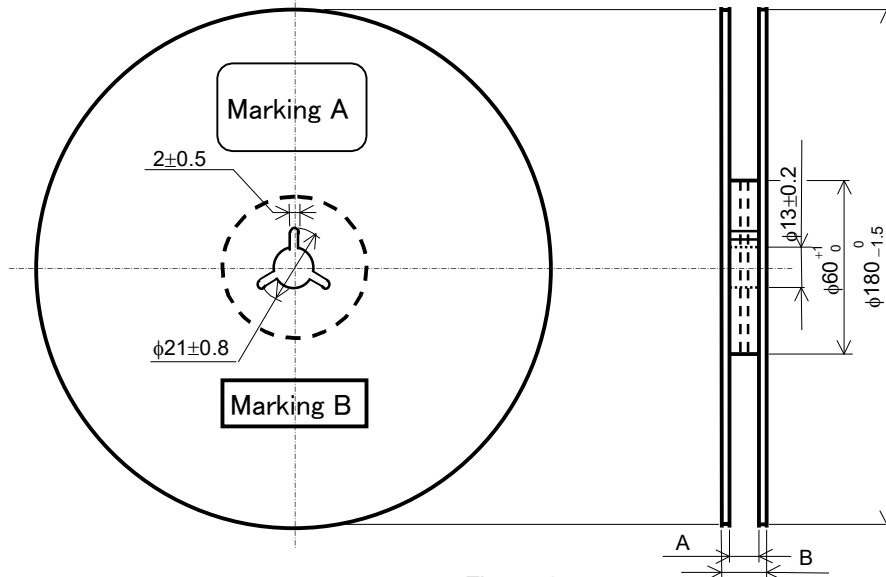

Figure-8

Table-7

Unit: mm

| Style | A | B | Note |
|---------------|-----------------------------------------------------|------------|-------------------|
| RNC06, 20, 32 | 9 $\begin{smallmatrix} +1.0 \\ 0 \end{smallmatrix}$ | 11.4 ± 1.0 | Injection molding |
| | | 13 ± 1.0 | Vacuum forming |

Note: Marking label shall be marked on a place of Marking A or two place of marking A and B.

8.4 Leader and trailer tape.

(Example)

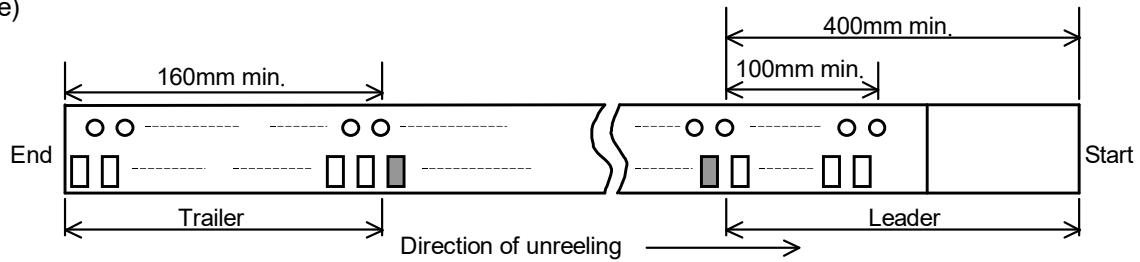

Figure-9

9. Marking on package

The label of a minimum package shall be legibly marked with follows.

9.1 Marking A

(1) Classification

(Style, Temperature coefficient of resistance, Rated resistance, Tolerance on rated resistance, Packaging form)

(2) Quantity (3) Lot number (4) Manufacturer's name or trade mark (5) Others

9.2 Marking B (KAMAYA Control label)

10. Recommended land pattern

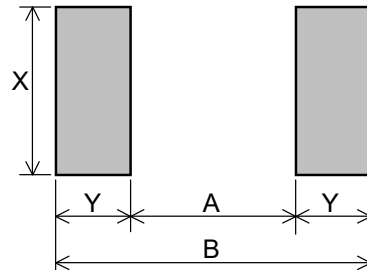

Unit:mm

| Size | | Flow soldering | | | | Reflow soldering | | | |
|--------|------|----------------|-----|------|------|------------------|-----|------|------|
| Metric | Inch | A | B | X | Y | A | B | X | Y |
| 0603 | 0201 | Not applied | | | | 0.3 | 0.9 | 0.3 | 0.3 |
| 2012 | 0805 | 1.3 | 3.1 | 1.25 | 0.9 | 1.3 | 2.7 | 1.25 | 0.7 |
| 3216 | 1206 | 2.2 | 4.3 | 1.6 | 1.05 | 2.2 | 3.9 | 1.6 | 0.85 |

11. Recommended soldering condition

The following condition corresponds to the lead free paste and the lead content paste.

11.1 Reflow Soldering (Temperature profile)

Reflow times: 2 times

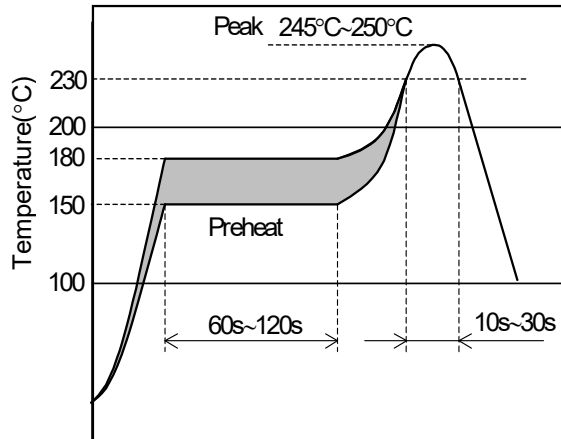

11.2 Wave Soldering (Temperature profile)

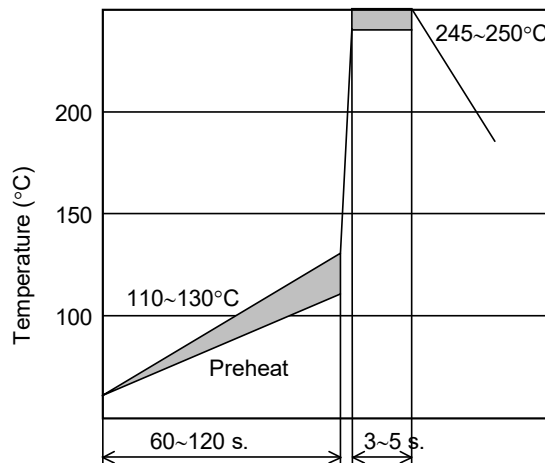

11.3 Soldering iron

- (1) Temperature of soldering iron tip: 300 °C, Duration: Within 10s
- (2) Temperature of soldering iron tip: 350 °C, Duration: Within 3 s