

| LOC | DIST | REVISIONS / REVISIONI | | | |
|-----|---------|---|-----------|----------|-----------|
| P | LTR REV | DESCRIPTION / DESCRIZIONE | DATE DATA | DWN DIS. | APVD APP. |
| | A | FIRST ISSUE EC ET00-0065-99(WAS 96-51240) | MAR1999 | A.M. | O.C. |
| | AI | RELEASED FOR PRODUCTION (ET00-0190-99) | 06JUL1999 | G.S. | O.C. |
| | B | ADDED LOCKING DEVICE (ECR-06-028677) | 11DEC2006 | M.P. | O.C. |

SECTION A-A
(SEZIONE A-A)

OVERALL DIM. WITH SEC. LOCK OPENED
(INGOMBRO CON AGGANCIO SECONDARIO APERTO)

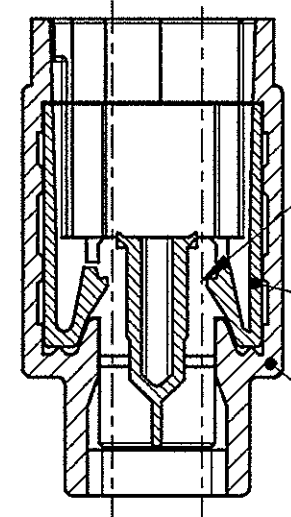
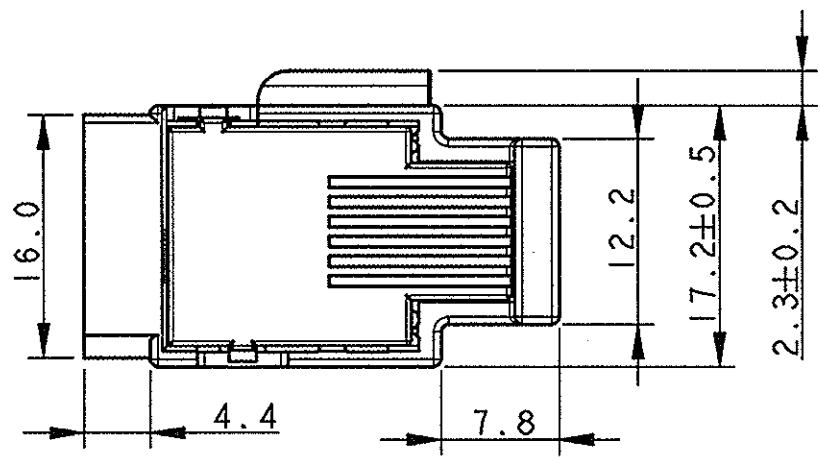

20 CAV. FOR NEW GENERATION MULTILOCK TAB CONTACT P/N 284080-1, 284107-1 AND 284108-1.
 (20 CAV. PER CONTATTI MASCHI NUOVA GENERAZIONE MULTILOCK P/N 284080-1, 284107-1 E 284108-1.)

OVERALL DIM. WITH SEC. LOCK CLOSED
(INGOMBRO CON AGGANCIO SECONDARIO CHIUSO)

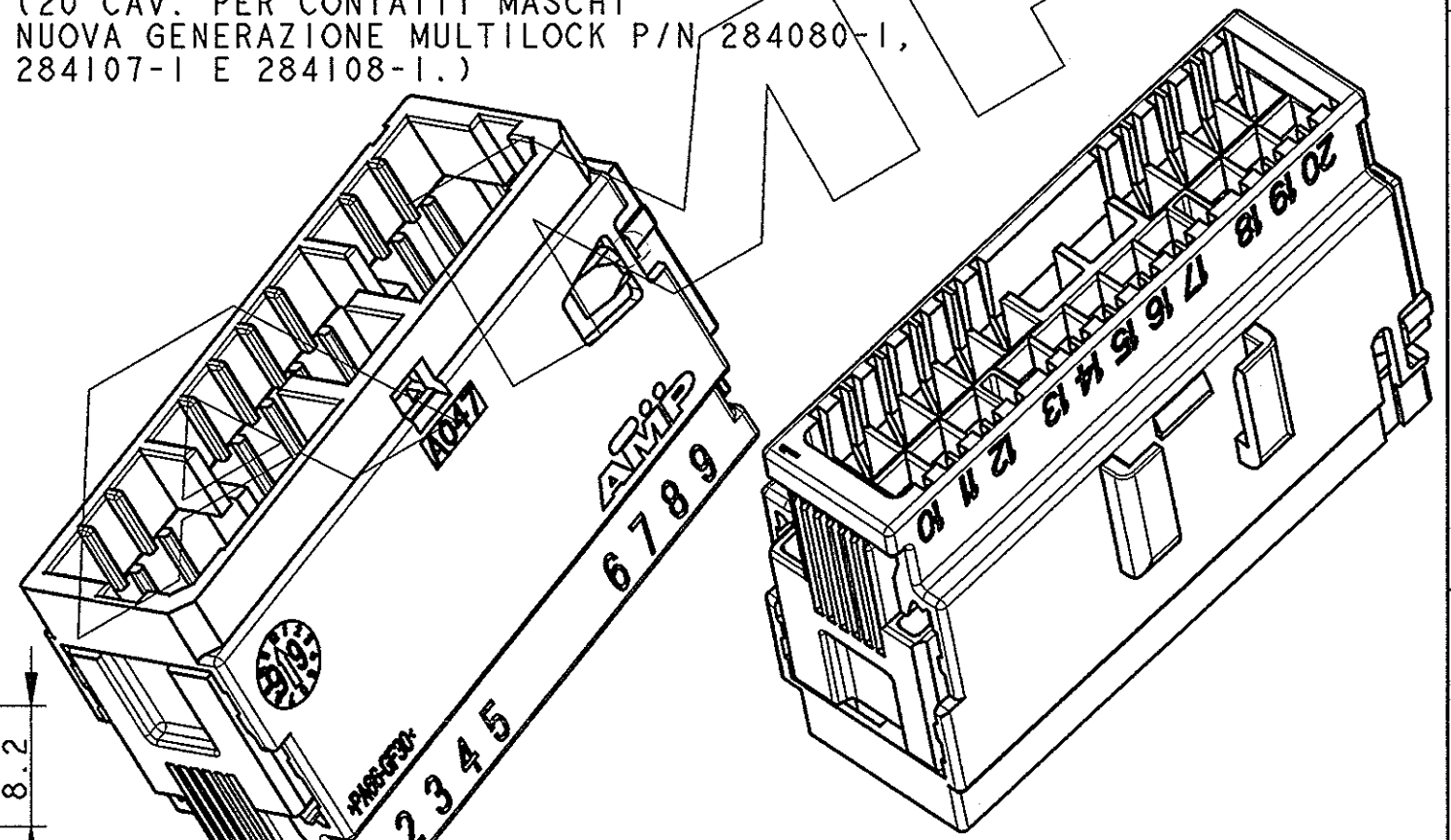
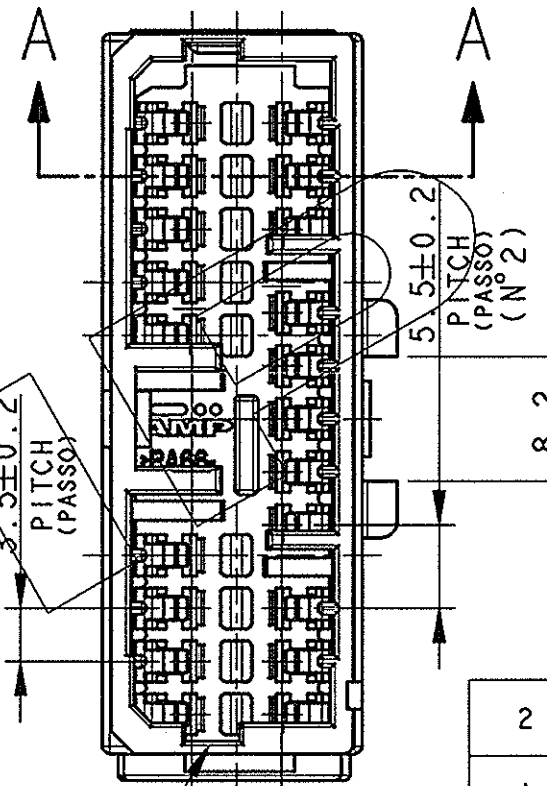
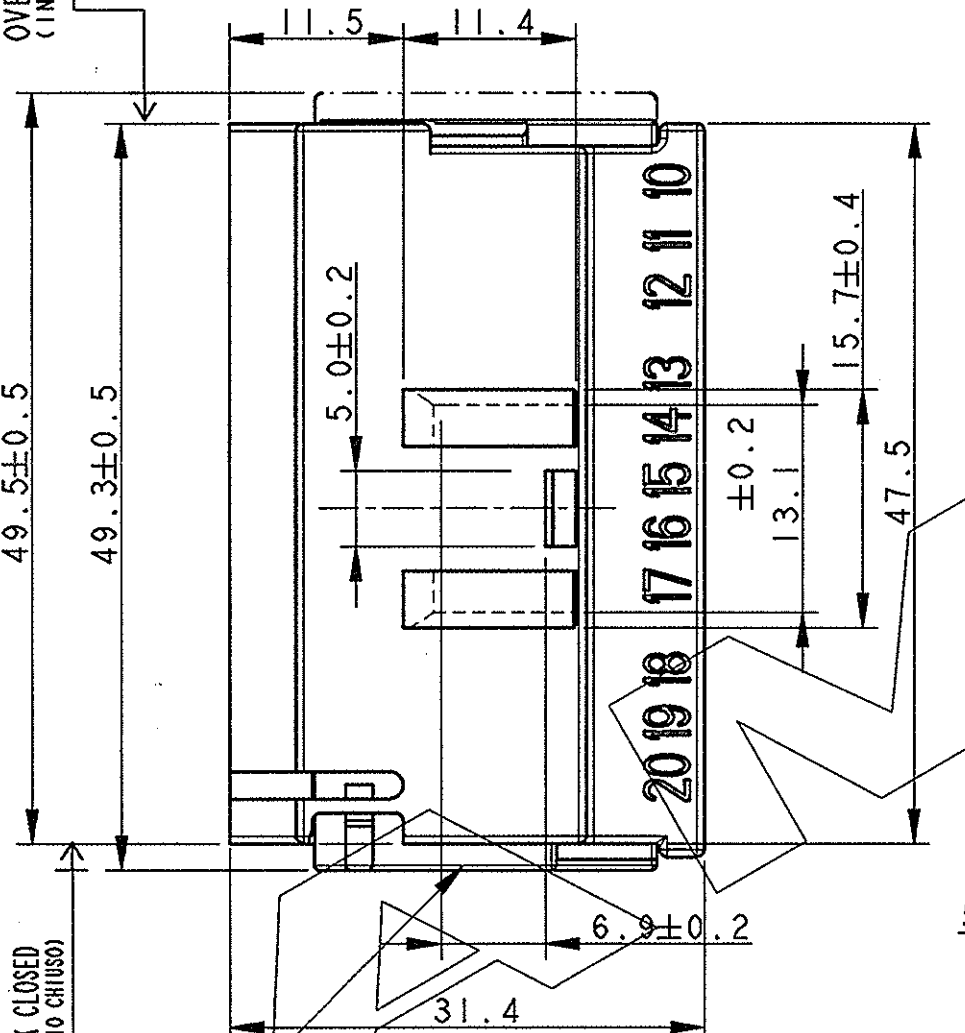

P/N 282994-2 AS SHOWN
(P/N 282994-2 COME MOSTRATO)

| ITEM | DESCRIPTION (DESCRIZIONE) | FINISH/COLOUR (FINITURA/COLORE) | MATERIAL (MATERIALE) | PART NUMBER (NUMERO) |
|------|---|---------------------------------|----------------------|---------------------------|
| 2 | RECEPTACLE HOUSING (BLOCC. PORTA FEMMINE) | SEE SHEET 2 VED. FOGLIO 2 | PA 66 G.F. | SEE SHEET 2 VED. FOGLIO 2 |
| 1 | SEC. LOCKING DEVICE (AGGANCIO SECONDARIO) | SEE SHEET 2 VED. FOGLIO 2 | PA 66 G.F. | SEE SHEET 2 VED. FOGLIO 2 |

FOR POLARIZATION DETAILS AND COUNTERPARTS P/N'S SEE SHEET 2
 (PER DETTAGLIO POLARIZZAZIONI E P/N'S CONTROPARTI VEDERE FOGLIO 2)

SUPPLIED WITH SEC. LOCKING DEVICE ON PRE-ASSEMBLED POSITION
 (FORNITO CON IL DISPOSITIVO DI AGGANCIO SECONDARIO IN POSIZIONE PRE-ASSEMBLATO)

| | | | | | |
|---|--|--|--|---|--|
| THIS DRAWING IS A CONTROLLED DOCUMENT FOR AMP INCORPORATED. IT IS SUBJECT TO CHANGE AND THE CONTROLLING ENGINEERING ORGANIZATION SHOULD BE CONTACTED FOR THE LATEST REVISION. / QUESTO DISEGNO E' UN DOCUMENTO DI PROPRIETA' E RESPONSABILITA' DELL'AMP ITALIA S.P.A. SOGGETTO A VARIAZIONI. PER OTTENERE L'ULTIMA REVISIONE DEL DISEGNO CONTATTARE AMP ITALIA S.P.A. | | DWN /DIS. 4-MAR-99 ANDREA MARANGON CHK /CONT. 4-MAR-99 OSCARE CANUTO APVD /APP. 4-MAR-99 ALESSANDRO GENTA | | AMP ITALIA SpA C.so F.lli Cervi 15 COLLEGNO (TO) | |
| DIMENSIONS: DIMENSIONI: mm TOLERANCES UNLESS OTHERWISE SPECIFIED: TOLLERANZE: SE NON DIVERSAMENTE SPECIFICATO | | PRODUCT SPEC SPEC. DI PRODOTTO 108-20175 APPLICATION SPEC SPEC. DI APPLICAZIONE 114-20095 | | NAME: 20 POS. NEW GENERATION TAB CONNECTOR for trucks SIZE: A3 CAGE CODE: 00779 | |
| MATERIAL: SEE TABLE (VEDERE TABELLA) FINISH: FINITURA - | | WEIGHT: PESO 13.0 g | | DRAWING NO. NUMERO: 282994 SCALE: 2:1 SHEET: FOGLIO 1 OF 2 REV: B | |
| | | CUSTOMER DRAWING FOR REFERENCE ONLY / DISEGNO PER CLIENTE SOLO PER RIFERIMENTO | | | |

THIS DRAWING IS UNPUBLISHED. QUESTO DISEGNO NON DEVE ESSERE DIVULGATO O RIPRODOTTO. RELEASED FOR PUBLICATION E' CONSENTITA LA DIVULGAZIONE. ALL RIGHTS RESERVED. TUTTI I DIRITTI SONO RISERVATI. BY AMP INCORPORATED.

LOC 1 DIST -

| REVISIONS REVISIONI | | | | | |
|---------------------|---------|-------------------------------------|-----------|----------|-----------|
| P | LTR REV | DESCRIPTION DESCRIZIONE | DATE DATA | DWN DIS. | APVD APP. |
| - | - | SEE SHEETS HIE ET (VEDERE FOGLIO 1) | - | - | - |

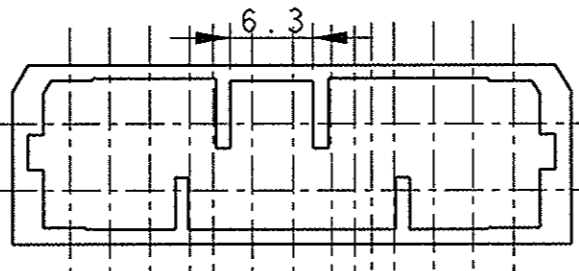
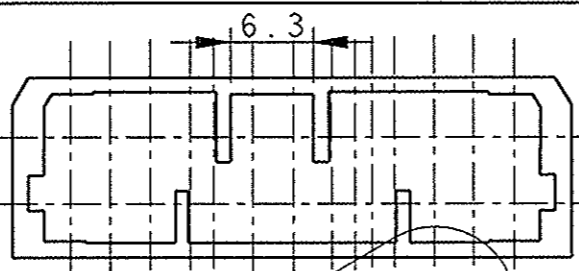
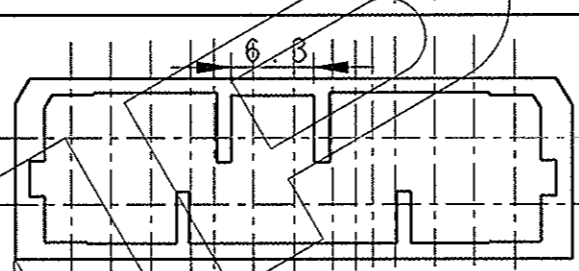
| P/N | ITEM 1-2 COLOUR (COLORE) | GRAPHIC REPRESENTATION MATING FACE (RAPPRESENTAZIONE GRAFICA LATO ACCOPPIAMENTO) | P/N FREE HANGING COUNTERPART (CONTROPARTE VOLANTE) |
|----------|--------------------------|--|--|
| 282994-2 | BLACK (NERO) |  | 282991-2 |
| 282994-3 | BLUE (BLU) |  | 282991-3 |
| 282994-4 | GREY (GRIGIO) |  | 282991-4 |

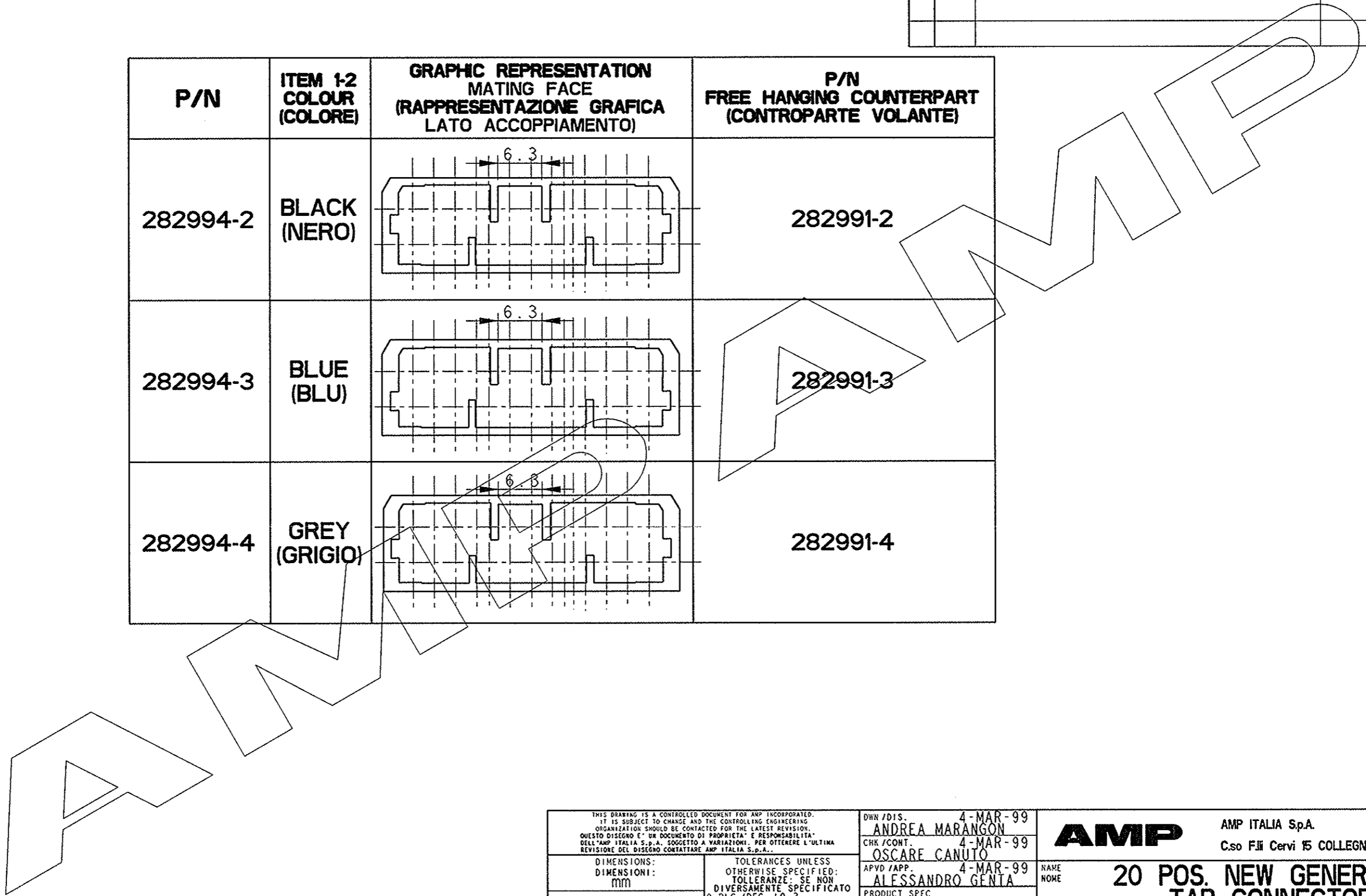

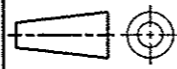
| | | | | | |
|--|--|---|--|---|--|
| <small>THIS DRAWING IS A CONTROLLED DOCUMENT FOR AMP INCORPORATED. IT IS SUBJECT TO CHANGE AND THE CONTROLLING ENGINEERING ORGANIZATION SHOULD BE CONTACTED FOR THE LATEST REVISION. QUESTO DISEGNO E' UN DOCUMENTO DI PROPRIETA' E RESPONSABILITA' DELL'AMP ITALIA S.p.A. SOGGETTO A VARIAZIONI. PER OTTENERE L'ULTIMA REVISIONE DEL DISEGNO CONTATTARE AMP ITALIA S.p.A.</small> | | DWN /DIS. 4-MAR-99 ANDREA MARANGON CHK /CONT. 4-MAR-99 OSCAR CANUTO APVD /APP. 4-MAR-99 ALESSANDRO GENTA | | AMP AMP ITALIA Sp.A. C.so F.lli Cervi 15 COLLEGNO (TO) | |
| DIMENSIONS: DIMENSIONI: mm  | | TOLERANCES UNLESS OTHERWISE SPECIFIED: TOLLERANZE: SE NON DIVERSAMENTE SPECIFICATO 0 PLC /DEC ±0.3 1 PLC /DEC ±0.3 2 PLC /DEC ±0.3 3 PLC /DEC ± 4 PLC /DEC ±- ANGLES /ANGOLI ±2 | | NAME NONE 20 POS. NEW GENERATION TAB CONNECTOR for trucks | |
| MATERIAL MATERIALE SEE SHEET (VEDERE FOGLIO 1) | | FINISH FINITURA - | | SIZE A3 CAGE CODE 00779 DRAWING NO. C= 282994 | |
| CUSTOMER DRAWING FOR REFERENCE ONLY | | DISEGNO PER CLIENTE SOLO PER RIFERIMENTO | | SCALE SCALA 2:1 SHEET FOGLIO 2 OF DI 2 REV B | |