

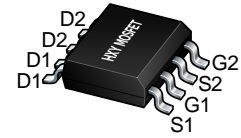

Description

The HXY4832S uses advanced trench technology to provide excellent $R_{DS(ON)}$, low gate charge and operation with gate voltages as low as 2.5V. This device is suitable for use as a Battery protection or in other Switching application.



SOP-8

General Features

$V_{DS} = 30V$ $I_D = 10A$
 $R_{DS(ON)} < 12m\Omega$ @ $V_{GS}=10V$
 $R_{DS(ON)} < 18m\Omega$ @ $V_{GS}=4.5V$

Application

Battery protection
 Load switch
 Uninterruptible power supply

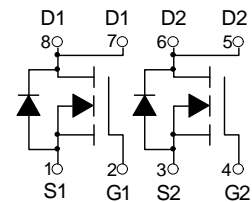

Dual N-Channel MOSFET

Package Marking and Ordering Information

Product ID	Pack	Marking	Qty(PCS)
HXY4832S	SOP-8	4832 XXX YYYY	3000

Absolute Maximum Ratings@ $T_J=25^\circ C$ (unless otherwise specified)

Symbol	Parameter	Rating	Units
V_{DS}	Drain-Source Voltage	30	V
V_{GS}	Gate-Source Voltage	± 20	V
$I_D@T_A=25^\circ C$	Drain Current, V_{GS} @ 4.5V ³	10	A
$I_D@T_A=70^\circ C$	Drain Current, V_{GS} @ 4.5V ³	8	A
I_{DM}	Pulsed Drain Current ¹	55	A
$P_D@T_A=25^\circ C$	Total Power Dissipation	2	W
T_{STG}	Storage Temperature Range	-55 to 150	$^\circ C$
T_J	Operating Junction Temperature Range	-55 to 150	$^\circ C$
R_{thj-a}	Maximum Thermal Resistance, Junction-ambient ³	62.5	$^\circ C/W$



Electrical Characteristics Ta = 25°C

Parameter	Symbol	Test Conditions	Min	Typ	Max	Unit	
Drain-Source Breakdown Voltage	V _{DSS}	I _D =250 μ A, V _{GS} =0V	30			V	
Zero Gate Voltage Drain Current	I _{DSS}	V _{DS} =30V, V _{GS} =0V			1	μA	
		V _{DS} =30V, V _{GS} =0V, T _J =55°C			5		
Gate-Body Leakage Current	I _{GSS}	V _{DS} =0V, V _{GS} =±20V			±100	nA	
Gate Threshold Voltage	V _{GS(th)}	V _{DS} =V _{GS} , I _D =250μA	1.5		2.5	V	
Static Drain-Source On-Resistance	R _{DS(on)}	V _{GS} =10V, I _D =10A			12	mΩ	
		V _{GS} =10V, I _D =10A T _J =125°C			18		
		V _{GS} =4.5 V, I _D =8A			16.5		
On State Drain Current	I _{D(ON)}	V _{GS} =10V, V _{DS} =5V	55			A	
Forward Transconductance	g _{FS}	V _{DS} =5V, I _D =10A		43		S	
Input Capacitance	C _{iss}	V _{GS} =0V, V _{DS} =15V, f=1MHz	610		910	pF	
Output Capacitance	C _{oss}		88		160		
Reverse Transfer Capacitance	C _{rss}		40		100		
Gate Resistance	R _g	V _{GS} =0V, V _{DS} =0V, f=1MHz	0.8		2.4	Ω	
Total Gate Charge (10V)	Q _g	V _{GS} =10V, V _{DS} =15V, I _D =10A	11		17	nC	
Total Gate Charge (4.5V)			5		8		
Gate Source Charge			Q _{gs}		2.4		
Gate Drain Charge			Q _{gd}		3		
Turn-On DelayTime	t _{d(on)}	V _{GS} =10V, V _{DS} =15V, R _L =1.5Ω, R _{GEN} =3Ω		4.4		ns	
Turn-On Rise Time	t _r			9			
Turn-Off DelayTime	t _{d(off)}			17			
Turn-Off Fall Time	t _f			6			
Body Diode Reverse Recovery Time	t _{rr}	I _F = 10A, di/dt= 500A/us	5.6		8	nC	
Body Diode Reverse Recovery Charge	Q _{rr}		6.4		9.6		
Maximum Body-Diode Continuous Current	I _S				2.5	A	
Diode Forward Voltage	V _{SD}	I _S =1A, V _{GS} =0V			1	V	

Note.The static characteristics in Figures 1 to 6 are obtained using <300us pulses, duty cycle 0.5% max.



Typical Characteristics

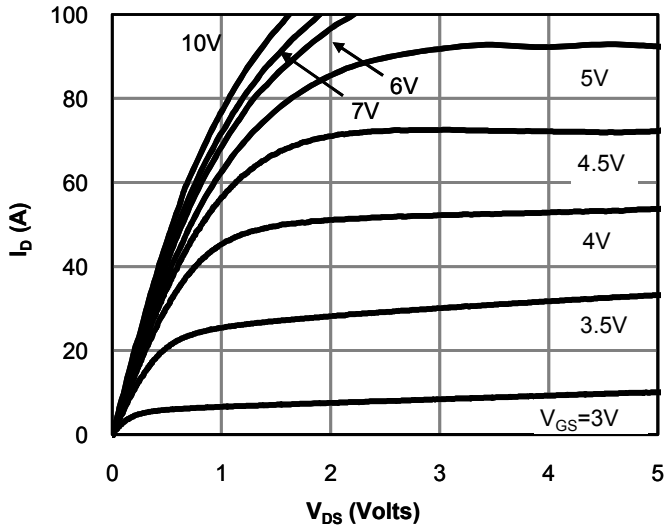

Fig 1: On-Region Characteristics (Note E)

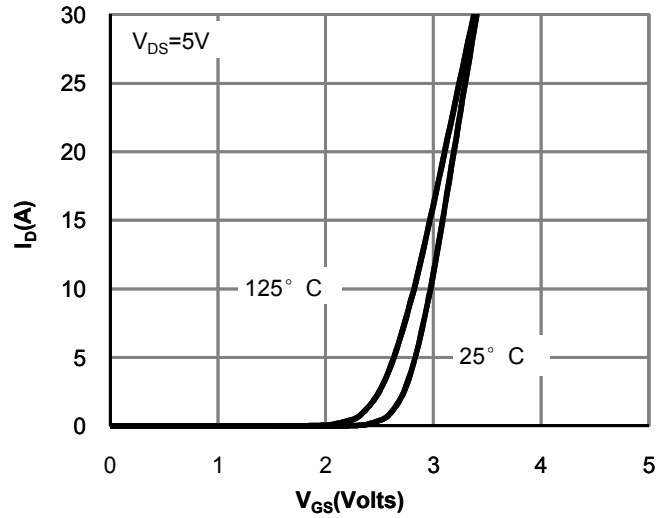

Figure 2: Transfer Characteristics (Note E)

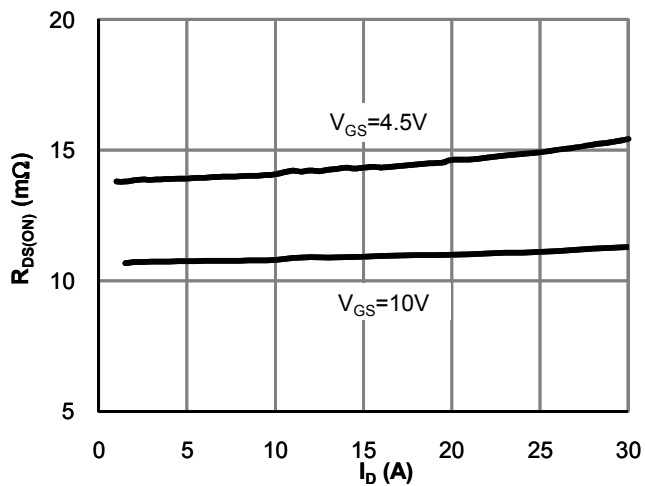

Figure 3: On-Resistance vs. Drain Current and Gate Voltage (Note E)

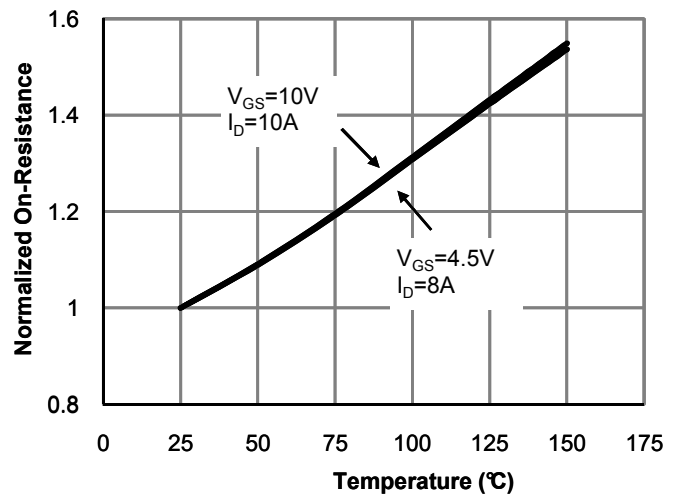

Figure 4: On-Resistance vs. Junction Temperature (Note E)

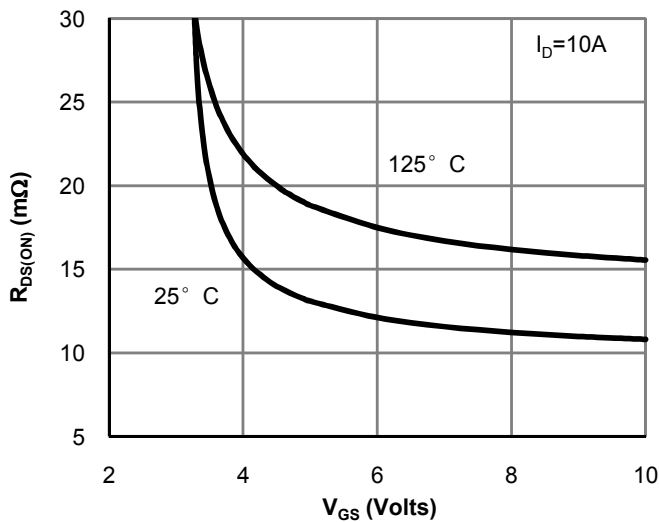

Figure 5: On-Resistance vs. Gate-Source Voltage (Note E)

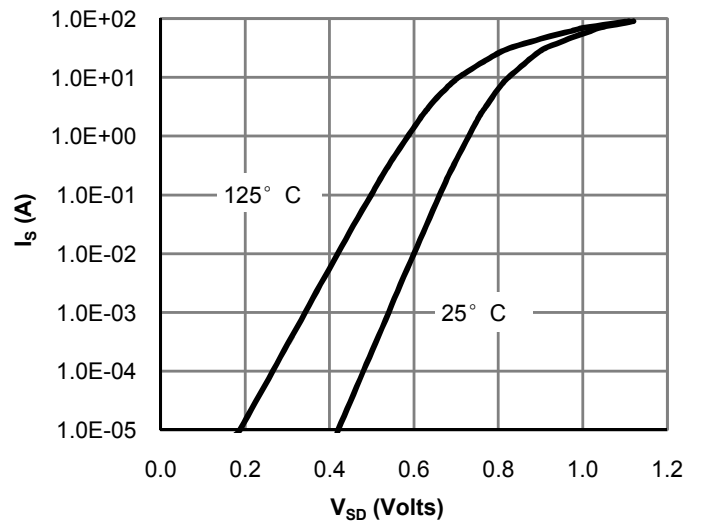

Figure 6: Body-Diode Characteristics (Note E)



Typical Characteristics

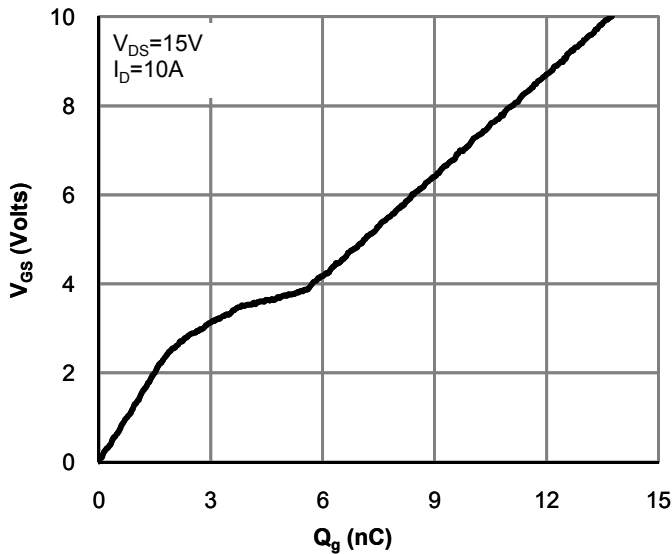

Figure 7: Gate-Charge Characteristics

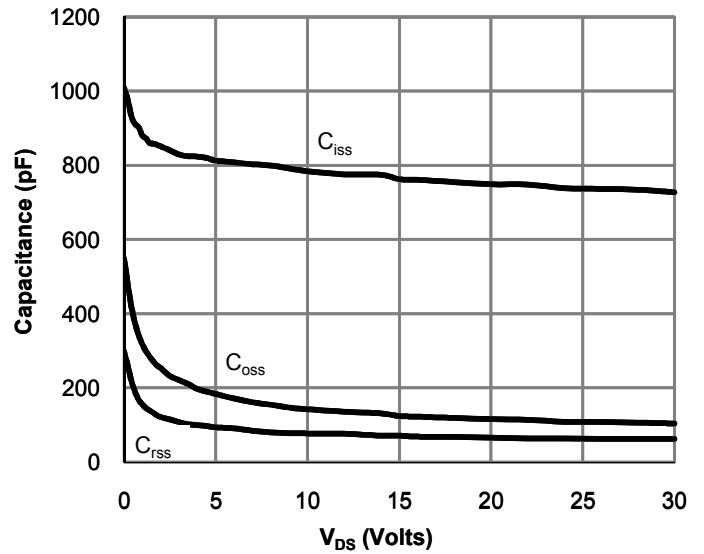

Figure 8: Capacitance Characteristics

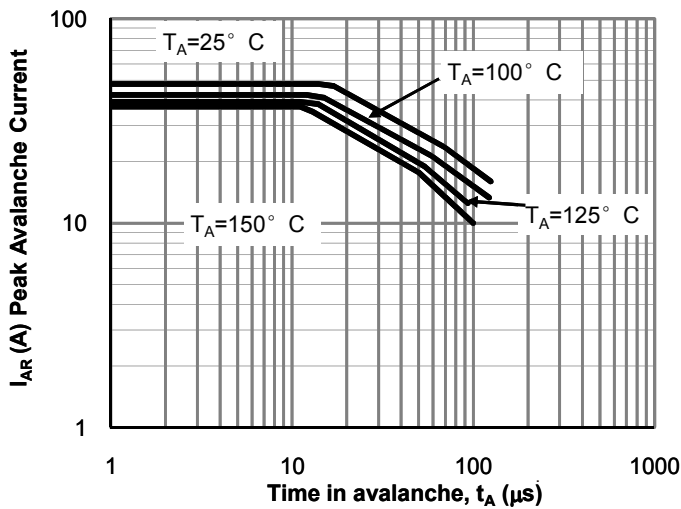

Figure 9: Single Pulse Avalanche capability (Note C)

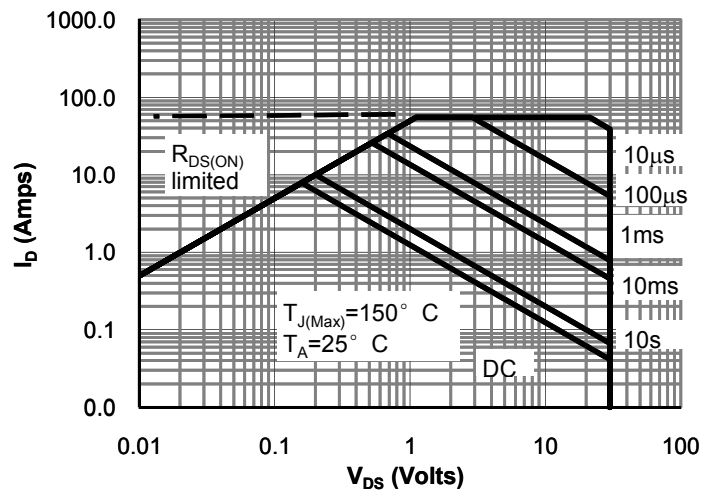

Figure 10: Maximum Forward Biased Safe Operating Area (Note F)

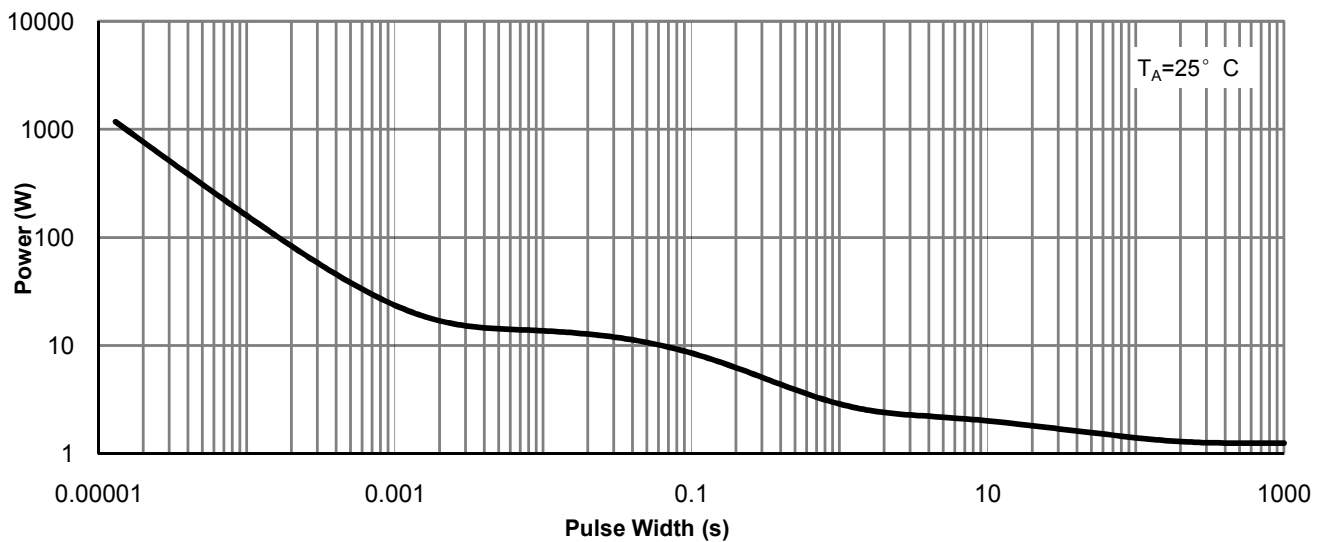

Figure 11: Single Pulse Power Rating Junction-to-Ambient (Note F)



Typical Characteristics

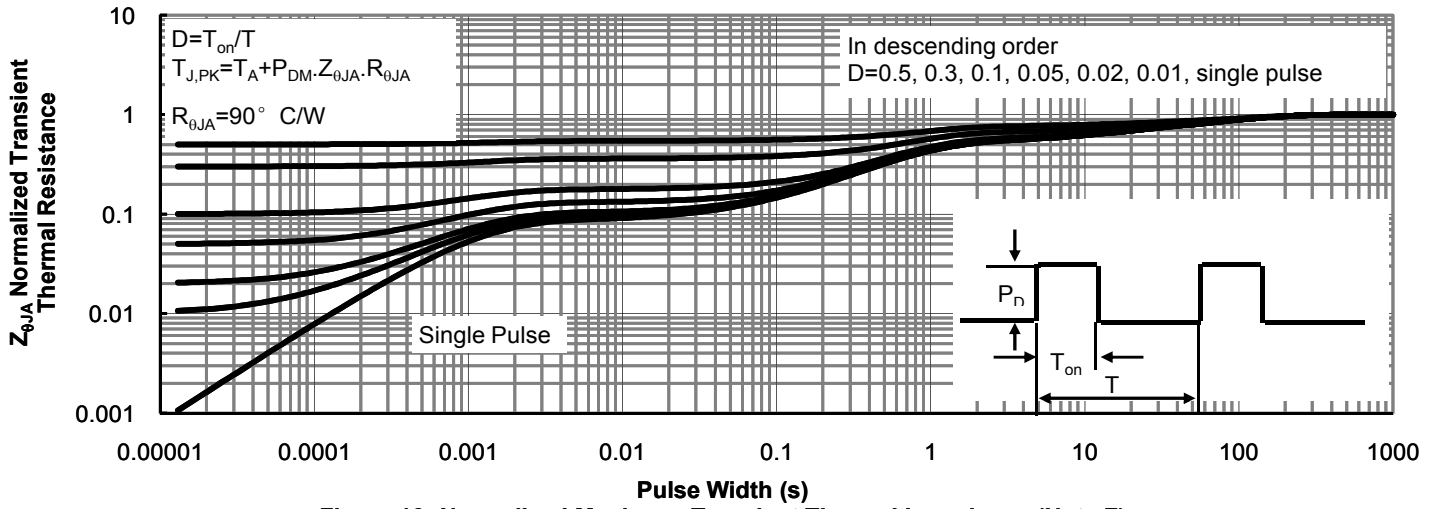
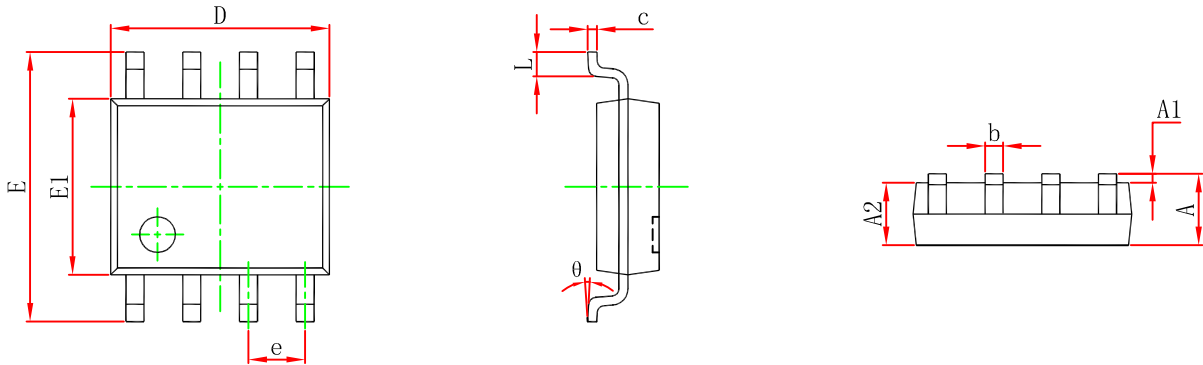

Figure 12: Normalized Maximum Transient Thermal Impedance (Note F)



SOP-8 Package Outline Dimensions



Symbol	Dimensions In Millimeters		Dimensions In Inches	
	Min	Max	Min	Max
A	1.350	1.750	0.053	0.069
A1	0.100	0.250	0.004	0.010
A2	1.350	1.550	0.053	0.061
b	0.330	0.510	0.013	0.020
c	0.170	0.250	0.007	0.010
D	4.800	5.000	0.189	0.197
e	1.270 (BSC)		0.050 (BSC)	
E	5.800	6.200	0.228	0.244
E1	3.800	4.000	0.150	0.157
L	0.400	1.270	0.016	0.050
θ	0°	8°	0°	8°

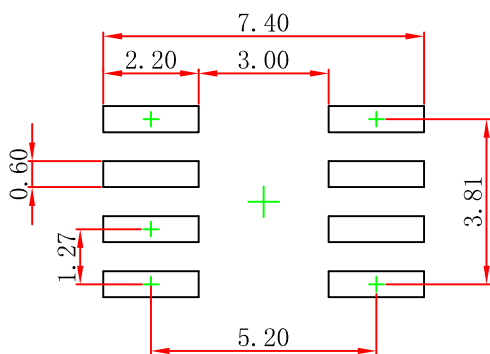

- Note:
1. Controlling dimension: in millimeters.
 2. General tolerance: $\pm 0.05\text{mm}$.
 3. The pad layout is for reference purposes only.



Attention

- Any and all HUA XUAN YANG ELECTRONICS products described or contained herein do not have specifications that can handle applications that require extremely high levels of reliability, such as life-support systems, aircraft's control systems, or other applications whose failure can be reasonably expected to result in serious physical and/or material damage. Consult with your HUA XUAN YANG ELECTRONICS representative nearest you before using any HUA XUAN YANG ELECTRONICS products described or contained herein in such applications.
- HUA XUAN YANG ELECTRONICS assumes no responsibility for equipment failures that result from using products at values that exceed, even momentarily, rated values (such as maximum ratings, operating condition ranges, or other parameters) listed in products specifications of any and all HUA XUAN YANG ELECTRONICS products described or contained herein.
- Specifications of any and all HUA XUAN YANG ELECTRONICS products described or contained herein stipulate the performance, characteristics, and functions of the described products in the independent state, and are not guarantees of the performance, characteristics, and functions of the described products as mounted in the customer's products or equipment. To verify symptoms and states that cannot be evaluated in an independent device, the customer should always evaluate and test devices mounted in the customer's products or equipment.
- HUA XUAN YANG ELECTRONICS CO.,LTD. strives to supply high-quality high-reliability products. However, any and all semiconductor products fail with some probability. It is possible that these probabilistic failures could give rise to accidents or events that could endanger human lives, that could give rise to smoke or fire, or that could cause damage to other property. When designing equipment, adopt safety measures so that these kinds of accidents or events cannot occur. Such measures include but are not limited to protective circuits and error prevention circuits for safe design, redundant design, and structural design.
- In the event that any or all HUA XUAN YANG ELECTRONICS products(including technical data, services) described or contained herein are controlled under any of applicable local export control laws and regulations, such products must not be exported without obtaining the export license from the authorities concerned in accordance with the above law.
- No part of this publication may be reproduced or transmitted in any form or by any means, electronic or mechanical, including photocopying and recording, or any information storage or retrieval system, or otherwise, without the prior written permission of HUA XUAN YANG ELECTRONICS CO.,LTD.
- Information (including circuit diagrams and circuit parameters) herein is for example only ; it is not guaranteed for volume production. HUA XUAN YANG ELECTRONICS believes information herein is accurate and reliable, but no guarantees are made or implied regarding its use or any infringements of intellectual property rights or other rights of third parties.
- Any and all information described or contained herein are subject to change without notice due to product/technology improvement, etc. When designing equipment, refer to the "Delivery Specification" for the HUA XUAN YANG ELECTRONICS product that you intend to use.