

General Purpose Transistors

NPN Silicon

BC846ALT1G Series

Features

- Moisture Sensitivity Level: 1
- ESD Rating – Human Body Model: > 4000 V
– Machine Model: > 400 V
- S and NSV Prefix for Automotive and Other Applications Requiring Unique Site and Control Change Requirements; AEC-Q101 Qualified and PPAP Capable
- These Devices are Pb-Free, Halogen Free/BFR Free and are RoHS Compliant

MAXIMUM RATINGS

Rating	Symbol	Value	Unit	
Collector-Emitter Voltage	V_{CE0}	BC846	65	Vdc
		BC847, BC850	45	
		BC848, BC849	30	
Collector-Base Voltage	V_{CBO}	BC846	80	Vdc
		BC847, BC850	50	
		BC848, BC849	30	
Emitter-Base Voltage	V_{EBO}	BC846	6.0	Vdc
		BC847, BC850	6.0	
		BC848, BC849	5.0	
Collector Current – Continuous	I_C	100	mAdc	

Stresses exceeding those listed in the Maximum Ratings table may damage the device. If any of these limits are exceeded, device functionality should not be assumed, damage may occur and reliability may be affected.

THERMAL CHARACTERISTICS

Characteristic	Symbol	Max	Unit
Total Device Dissipation FR-5 Board, (Note 1) $T_A = 25^\circ\text{C}$ Derate above 25°C	P_D	225	mW
		1.8	mW/ $^\circ\text{C}$
Thermal Resistance, Junction-to-Ambient (Note 1)	$R_{\theta JA}$	556	$^\circ\text{C}/\text{W}$
Total Device Dissipation Alumina Substrate (Note 2) $T_A = 25^\circ\text{C}$ Derate above 25°C	P_D	300	mW
		2.4	mW/ $^\circ\text{C}$
Thermal Resistance, Junction-to-Ambient (Note 2)	$R_{\theta JA}$	417	$^\circ\text{C}/\text{W}$
Junction and Storage Temperature Range	T_J, T_{stg}	-55 to +150	$^\circ\text{C}$

- FR-5 = $1.0 \times 0.75 \times 0.062$ in.
- Alumina = $0.4 \times 0.3 \times 0.024$ in 99.5% alumina.

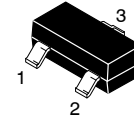
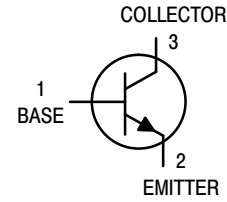

SOT-23
CASE 318
STYLE 6

MARKING DIAGRAM

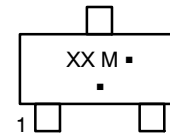

- XX = Device Code
- M = Date Code*
- = Pb-Free Package

(Note: Microdot may be in either location)

*Date Code orientation and/or overbar may vary depending upon manufacturing location.

ORDERING INFORMATION

See detailed ordering and shipping information in the package dimensions section on page 12 of this data sheet.

BC846ALT1G Series

ELECTRICAL CHARACTERISTICS ($T_A = 25^\circ\text{C}$ unless otherwise noted)

Characteristic	Symbol	Min	Typ	Max	Unit	
OFF CHARACTERISTICS						
Collector – Emitter Breakdown Voltage ($I_C = 10\text{ mA}$)	BC846A, B, C BC847A, B, C, BC850B, C BC848A, B, C, BC849B, C	$V_{(BR)CEO}$	65 45 30	– – –	– – –	V
Collector – Emitter Breakdown Voltage ($I_C = 10\ \mu\text{A}$, $V_{EB} = 0$)	BC846A, B, C BC847A, B, C, BC850B, C BC848A, B, C, BC849B, C	$V_{(BR)CES}$	80 50 30	– – –	– – –	V
Collector – Base Breakdown Voltage ($I_C = 10\ \mu\text{A}$)	BC846A, B, C BC847A, B, C, BC850B, C BC848A, B, C, BC849B, C	$V_{(BR)CBO}$	80 50 30	– – –	– – –	V
Emitter – Base Breakdown Voltage ($I_E = 1.0\ \mu\text{A}$)	BC846A, B, C BC847A, B, C, BC850B, C BC848A, B, C, BC849B, C	$V_{(BR)EBO}$	6.0 6.0 5.0	– – –	– – –	V
Collector Cutoff Current ($V_{CB} = 30\text{ V}$) ($V_{CB} = 30\text{ V}$, $T_A = 150^\circ\text{C}$)		I_{CBO}	– –	– –	15 5.0	nA μA
ON CHARACTERISTICS						
DC Current Gain ($I_C = 10\ \mu\text{A}$, $V_{CE} = 5.0\text{ V}$)	BC846A, BC847A, BC848A BC846B, BC847B, BC848B BC846C, BC847C, BC848C	h_{FE}	– – –	90 150 270	– – –	–
($I_C = 2.0\text{ mA}$, $V_{CE} = 5.0\text{ V}$)	BC846A, BC847A, BC848A BC846B, BC847B, BC848B, BC849B, BC850B BC846C, BC847C, BC848C, BC849C, BC850C		110 200 420	180 290 520	220 450 800	
Collector – Emitter Saturation Voltage ($I_C = 10\text{ mA}$, $I_B = 0.5\text{ mA}$) ($I_C = 100\text{ mA}$, $I_B = 5.0\text{ mA}$)		$V_{CE(sat)}$	– –	– –	0.25 0.6	V
Base – Emitter Saturation Voltage ($I_C = 10\text{ mA}$, $I_B = 0.5\text{ mA}$) ($I_C = 100\text{ mA}$, $I_B = 5.0\text{ mA}$)		$V_{BE(sat)}$	– –	0.7 0.9	– –	V
Base – Emitter Voltage ($I_C = 2.0\text{ mA}$, $V_{CE} = 5.0\text{ V}$) ($I_C = 10\text{ mA}$, $V_{CE} = 5.0\text{ V}$)		$V_{BE(on)}$	580 –	660 –	700 770	mV
SMALL-SIGNAL CHARACTERISTICS						
Current – Gain – Bandwidth Product ($I_C = 10\text{ mA}$, $V_{CE} = 5.0\text{ Vdc}$, $f = 100\text{ MHz}$)		f_T	100	–	–	MHz
Output Capacitance ($V_{CB} = 10\text{ V}$, $f = 1.0\text{ MHz}$)		C_{obo}	–	–	4.5	pF
Noise Figure ($I_C = 0.2\text{ mA}$, $V_{CE} = 5.0\text{ Vdc}$, $R_S = 2.0\text{ k}\Omega$, $f = 1.0\text{ kHz}$, $BW = 200\text{ Hz}$)	BC846A,B,C, BC847A,B,C, BC848A,B,C BC849B,C, BC850B,C	NF	– –	– –	10 4.0	dB

Product parametric performance is indicated in the Electrical Characteristics for the listed test conditions, unless otherwise noted. Product performance may not be indicated by the Electrical Characteristics if operated under different conditions.

BC846ALT1G Series

BC846A, BC847A, BC848A, SBC846A

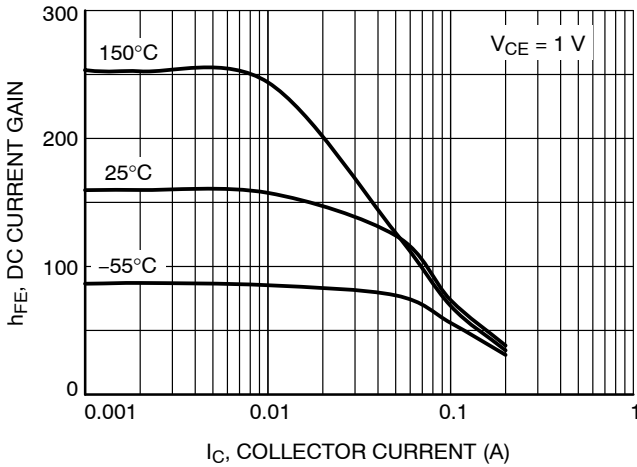

Figure 1. DC Current Gain vs. Collector Current

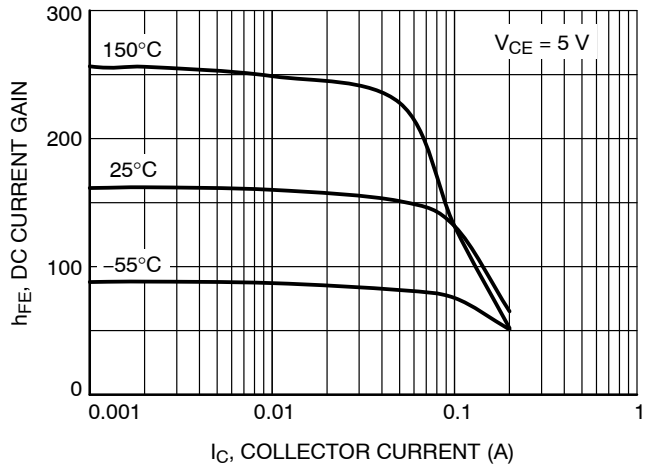

Figure 2. DC Current Gain vs. Collector Current



Figure 3. Collector Emitter Saturation Voltage vs. Collector Current

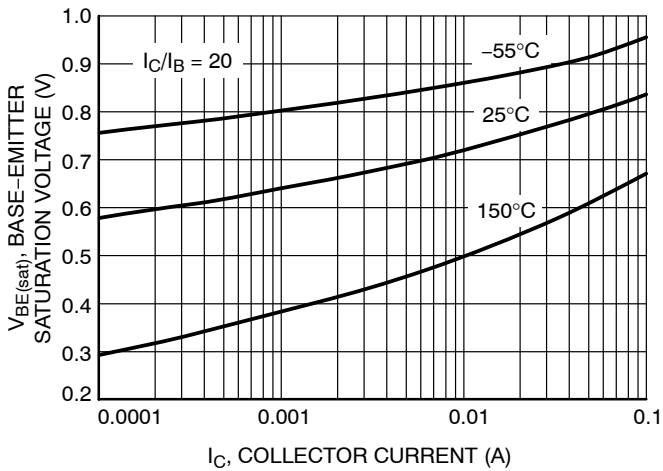

Figure 4. Base Emitter Saturation Voltage vs. Collector Current



Figure 5. Base Emitter Voltage vs. Collector Current

BC846ALT1G Series

BC846A, BC847A, BC848A, SBC846A

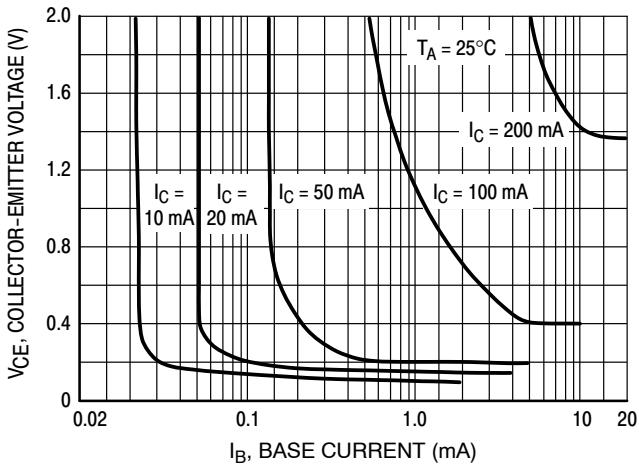

Figure 6. Collector Saturation Region



Figure 7. Base-Emitter Temperature Coefficient



Figure 8. Capacitances

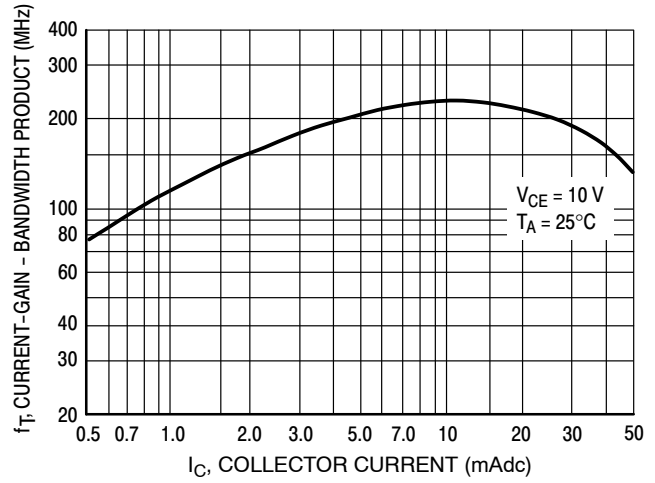

Figure 9. Current-Gain - Bandwidth Product

BC846ALT1G Series

BC846B, SBC846B

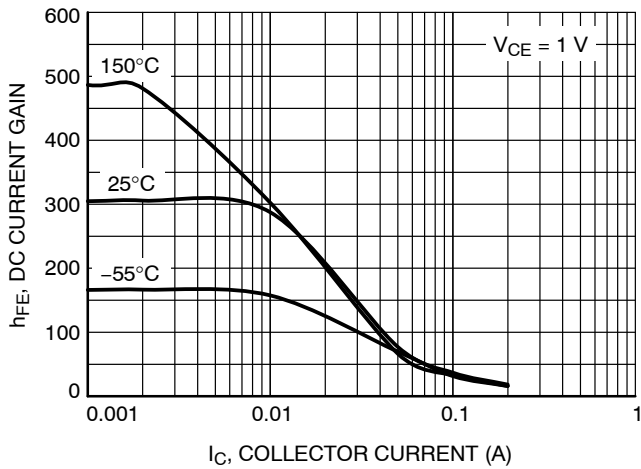

Figure 10. DC Current Gain vs. Collector Current

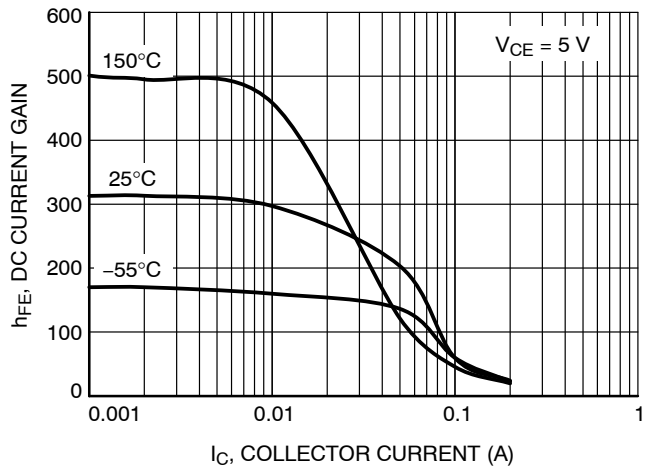

Figure 11. DC Current Gain vs. Collector Current



Figure 12. Collector Emitter Saturation Voltage vs. Collector Current



Figure 13. Base Emitter Saturation Voltage vs. Collector Current



Figure 14. Base Emitter Voltage vs. Collector Current

BC846ALT1G Series

BC846B, SBC846B

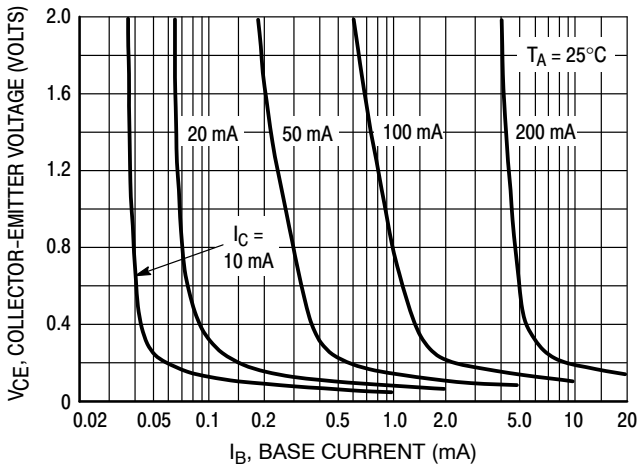

Figure 15. Collector Saturation Region



Figure 16. Base-Emitter Temperature Coefficient

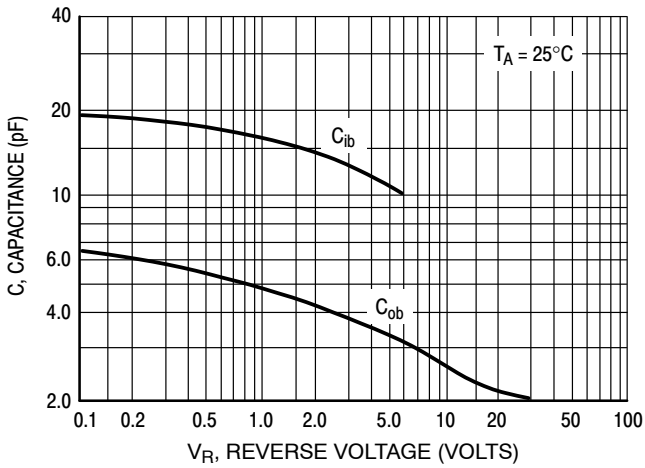

Figure 17. Capacitance

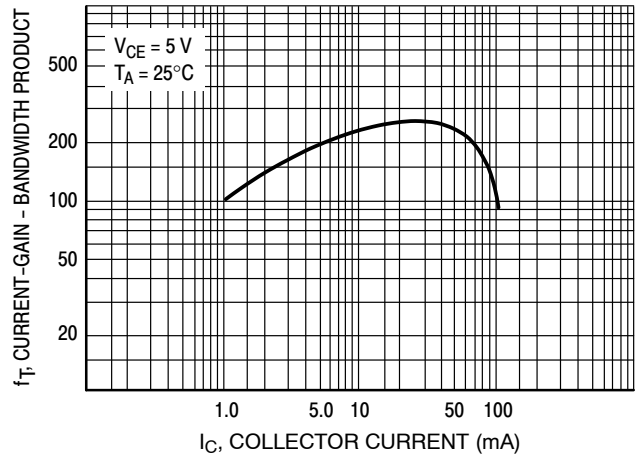

Figure 18. Current-Gain - Bandwidth Product

BC846ALT1G Series

BC847B, BC848B, BC849B, BC850B, SBC847B, SBC848B

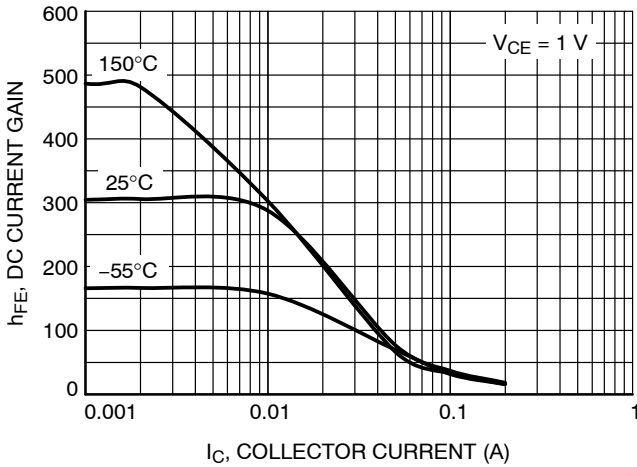

Figure 19. DC Current Gain vs. Collector Current

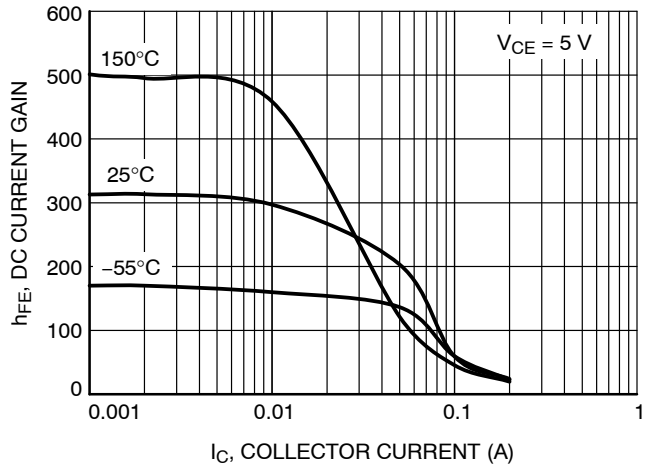

Figure 20. DC Current Gain vs. Collector Current



Figure 21. Collector Emitter Saturation Voltage vs. Collector Current

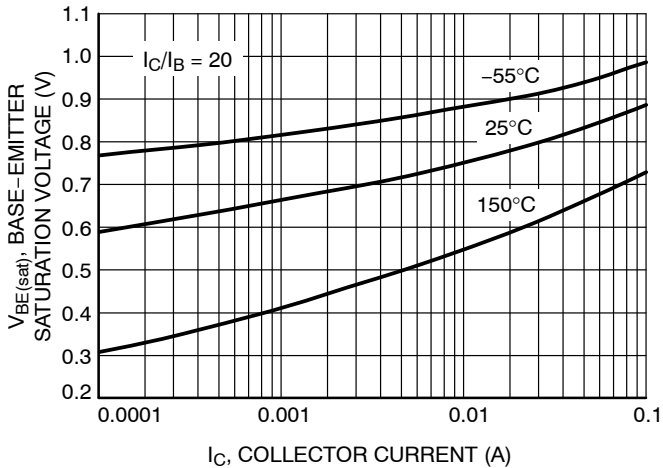

Figure 22. Base Emitter Saturation Voltage vs. Collector Current



Figure 23. Base Emitter Voltage vs. Collector Current

BC846ALT1G Series

BC847B, BC848B, BC849B, BC850B, SBC846B, SBC847B, SBC848B



Figure 24. Collector Saturation Region



Figure 25. Base-Emitter Temperature Coefficient



Figure 26. Capacitances



Figure 27. Current-Gain - Bandwidth Product

BC846ALT1G Series

BC846C, BC847C, BC848C, BC849C, BC850C, SBC847C

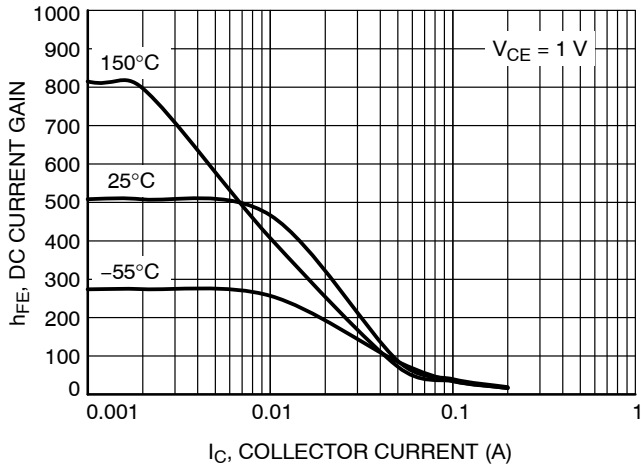

Figure 28. DC Current Gain vs. Collector Current



Figure 29. DC Current Gain vs. Collector Current



Figure 30. Collector Emitter Saturation Voltage vs. Collector Current



Figure 31. Base Emitter Saturation Voltage vs. Collector Current



Figure 32. Base Emitter Voltage vs. Collector Current

BC846ALT1G Series

BC846C, BC847C, BC848C, BC849C, BC850C, SBC847C



Figure 33. Collector Saturation Region



Figure 34. Base-Emitter Temperature Coefficient

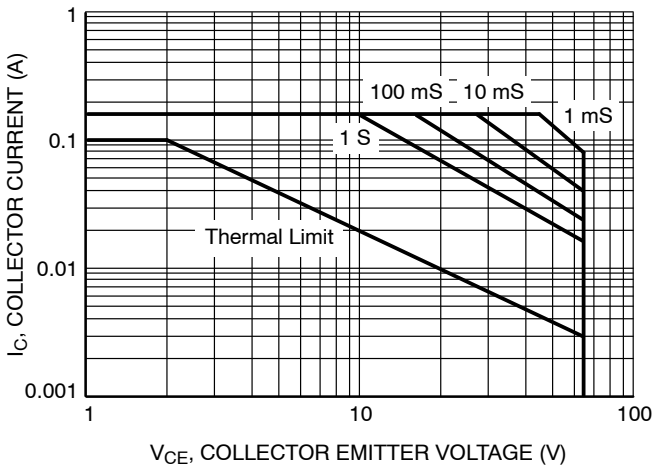

Figure 35. Capacitances

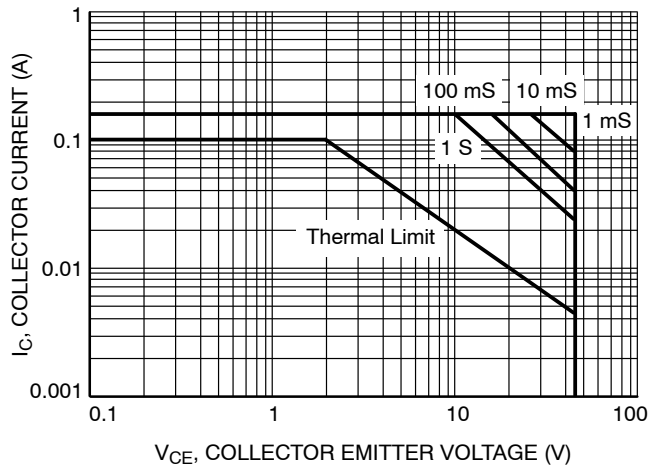

Figure 36. Current-Gain - Bandwidth Product

BC846ALT1G Series



**Figure 37. Safe Operating Area for
BC846A, BC846B, BC846C**



**Figure 38. Safe Operating Area for
BC847A, BC847B, BC847C, BC850B, BC850C**

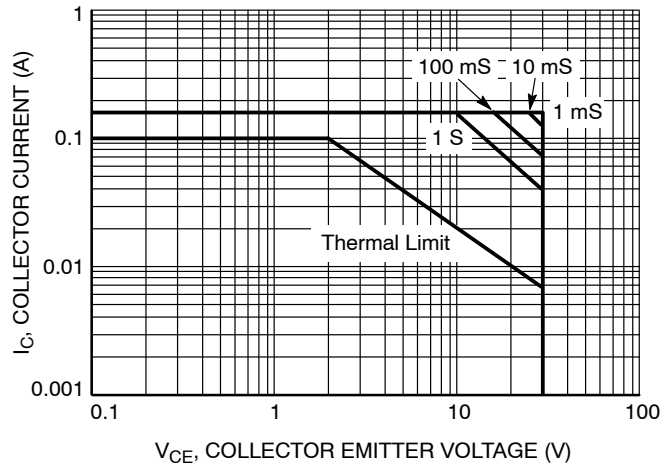

**Figure 39. Safe Operating Area for
BC848A, BC848B, BC848C, BC849B, BC849C**

BC846ALT1G Series

ORDERING INFORMATION

Device	Marking	Package	Shipping†
BC846ALT1G	1A	SOT-23 (Pb-Free)	3,000 / Tape & Reel
SBC846ALT1G*			
BC846ALT3G			10,000 / Tape & Reel
BC846BLT1G	1B		3,000 / Tape & Reel
SBC846BLT1G*			
BC846BLT3G			10,000 / Tape & Reel
SBC846BLT3G*			
BC846CLT1G	3C		3,000 / Tape & Reel
BC847ALT1G	1E		3,000 / Tape & Reel
BC847ALT3G			10,000 / Tape & Reel
BC847BLT1G	1F		3,000 / Tape & Reel
SBC847BLT1G*			
BC847BLT3G			10,000 / Tape & Reel
NSVBC847BLT3G*			
BC847CLT1G	1G		3,000 / Tape & Reel
SBC847CLT1G*			
BC847CLT3G			10,000 / Tape & Reel
BC848ALT1G	1J		3,000 / Tape & Reel
BC848BLT1G	1K		3,000 / Tape & Reel
SBC848BLT1G*			
BC848BLT3G			10,000 / Tape & Reel
BC848CLT1G	1L		3,000 / Tape & Reel
NSVBC848CLT1G*			
BC848CLT3G			10,000 / Tape & Reel
BC849BLT1G	2B		3,000 / Tape & Reel
NSVBC849BLT1G*			
BC849BLT3G			10,000 / Tape & Reel
BC849CLT1G	2C		3,000 / Tape & Reel
BC849CLT3G			10,000 / Tape & Reel
BC850BLT1G	2F		3,000 / Tape & Reel
NSVBC850BLT1G*			
BC850CLT1G	2G		
NSVBC850CLT1G*			

†For information on tape and reel specifications, including part orientation and tape sizes, please refer to our Tape and Reel Packaging Specifications Brochure, BRD8011/D.

*S and NSV Prefix for Automotive and Other Applications Requiring Unique Site and Control Change Requirements; AEC-Q101 Qualified and PPAP Capable.

MECHANICAL CASE OUTLINE

PACKAGE DIMENSIONS

ON Semiconductor®



SOT-23 (TO-236)
CASE 318-08
ISSUE AS

DATE 30 JAN 2018

SCALE 4:1



NOTES:

1. DIMENSIONING AND TOLERANCING PER ASME Y14.5M, 1994.
2. CONTROLLING DIMENSION: MILLIMETERS.
3. MAXIMUM LEAD THICKNESS INCLUDES LEAD FINISH. MINIMUM LEAD THICKNESS IS THE MINIMUM THICKNESS OF THE BASE MATERIAL.
4. DIMENSIONS D AND E DO NOT INCLUDE MOLD FLASH, PROTRUSIONS, OR GATE BURRS.

DIM	MILLIMETERS			INCHES		
	MIN	NOM	MAX	MIN	NOM	MAX
A	0.89	1.00	1.11	0.035	0.039	0.044
A1	0.01	0.06	0.10	0.000	0.002	0.004
b	0.37	0.44	0.50	0.015	0.017	0.020
c	0.08	0.14	0.20	0.003	0.006	0.008
D	2.80	2.90	3.04	0.110	0.114	0.120
E	1.20	1.30	1.40	0.047	0.051	0.055
e	1.78	1.90	2.04	0.070	0.075	0.080
L	0.30	0.43	0.55	0.012	0.017	0.022
L1	0.35	0.54	0.69	0.014	0.021	0.027
HE	2.10	2.40	2.64	0.083	0.094	0.104
T	0°	---	10°	0°	---	10°

RECOMMENDED SOLDERING FOOTPRINT

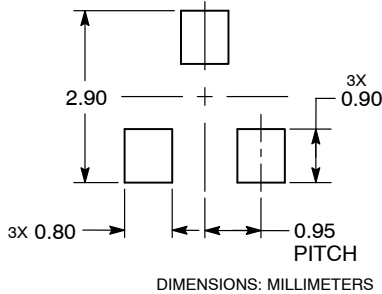

GENERIC MARKING DIAGRAM*



XXX = Specific Device Code
M = Date Code
▪ = Pb-Free Package

*This information is generic. Please refer to device data sheet for actual part marking. Pb-Free indicator, "G" or microdot "▪", may or may not be present.

STYLE 1 THRU 5:
CANCELLED

STYLE 6:
PIN 1. BASE
2. EMITTER
3. COLLECTOR

STYLE 7:
PIN 1. EMITTER
2. BASE
3. COLLECTOR

STYLE 8:
PIN 1. ANODE
2. NO CONNECTION
3. CATHODE

STYLE 9:
PIN 1. ANODE
2. ANODE
3. CATHODE

STYLE 10:
PIN 1. DRAIN
2. SOURCE
3. GATE

STYLE 11:
PIN 1. ANODE
2. CATHODE
3. CATHODE-ANODE

STYLE 12:
PIN 1. CATHODE
2. CATHODE
3. ANODE

STYLE 13:
PIN 1. SOURCE
2. DRAIN
3. GATE

STYLE 14:
PIN 1. CATHODE
2. GATE
3. ANODE

STYLE 15:
PIN 1. GATE
2. CATHODE
3. ANODE

STYLE 16:
PIN 1. ANODE
2. CATHODE
3. CATHODE

STYLE 17:
PIN 1. NO CONNECTION
2. ANODE
3. CATHODE

STYLE 18:
PIN 1. NO CONNECTION
2. CATHODE
3. ANODE

STYLE 19:
PIN 1. CATHODE
2. ANODE
3. CATHODE-ANODE

STYLE 20:
PIN 1. CATHODE
2. ANODE
3. GATE

STYLE 21:
PIN 1. GATE
2. SOURCE
3. DRAIN

STYLE 22:
PIN 1. RETURN
2. OUTPUT
3. INPUT

STYLE 23:
PIN 1. ANODE
2. ANODE
3. CATHODE

STYLE 24:
PIN 1. GATE
2. DRAIN
3. SOURCE

STYLE 25:
PIN 1. ANODE
2. CATHODE
3. GATE

STYLE 26:
PIN 1. CATHODE
2. ANODE
3. NO CONNECTION

STYLE 27:
PIN 1. CATHODE
2. CATHODE
3. CATHODE

STYLE 28:
PIN 1. ANODE
2. ANODE
3. ANODE

DOCUMENT NUMBER:	98ASB42226B	Electronic versions are uncontrolled except when accessed directly from the Document Repository. Printed versions are uncontrolled except when stamped "CONTROLLED COPY" in red.
DESCRIPTION:	SOT-23 (TO-236)	PAGE 1 OF 1

ON Semiconductor and ON are trademarks of Semiconductor Components Industries, LLC dba ON Semiconductor or its subsidiaries in the United States and/or other countries. ON Semiconductor reserves the right to make changes without further notice to any products herein. ON Semiconductor makes no warranty, representation or guarantee regarding the suitability of its products for any particular purpose, nor does ON Semiconductor assume any liability arising out of the application or use of any product or circuit, and specifically disclaims any and all liability, including without limitation special, consequential or incidental damages. ON Semiconductor does not convey any license under its patent rights nor the rights of others.

onsemi, **Onsemi**, and other names, marks, and brands are registered and/or common law trademarks of Semiconductor Components Industries, LLC dba "**onsemi**" or its affiliates and/or subsidiaries in the United States and/or other countries. **onsemi** owns the rights to a number of patents, trademarks, copyrights, trade secrets, and other intellectual property. A listing of **onsemi**'s product/patent coverage may be accessed at www.onsemi.com/site/pdf/Patent-Marking.pdf. **onsemi** reserves the right to make changes at any time to any products or information herein, without notice. The information herein is provided "as-is" and **onsemi** makes no warranty, representation or guarantee regarding the accuracy of the information, product features, availability, functionality, or suitability of its products for any particular purpose, nor does **onsemi** assume any liability arising out of the application or use of any product or circuit, and specifically disclaims any and all liability, including without limitation special, consequential or incidental damages. Buyer is responsible for its products and applications using **onsemi** products, including compliance with all laws, regulations and safety requirements or standards, regardless of any support or applications information provided by **onsemi**. "Typical" parameters which may be provided in **onsemi** data sheets and/or specifications can and do vary in different applications and actual performance may vary over time. All operating parameters, including "Typicals" must be validated for each customer application by customer's technical experts. **onsemi** does not convey any license under any of its intellectual property rights nor the rights of others. **onsemi** products are not designed, intended, or authorized for use as a critical component in life support systems or any FDA Class 3 medical devices or medical devices with a same or similar classification in a foreign jurisdiction or any devices intended for implantation in the human body. Should Buyer purchase or use **onsemi** products for any such unintended or unauthorized application, Buyer shall indemnify and hold **onsemi** and its officers, employees, subsidiaries, affiliates, and distributors harmless against all claims, costs, damages, and expenses, and reasonable attorney fees arising out of, directly or indirectly, any claim of personal injury or death associated with such unintended or unauthorized use, even if such claim alleges that **onsemi** was negligent regarding the design or manufacture of the part. **onsemi** is an Equal Opportunity/Affirmative Action Employer. This literature is subject to all applicable copyright laws and is not for resale in any manner.

PUBLICATION ORDERING INFORMATION

LITERATURE FULFILLMENT:

Email Requests to: orderlit@onsemi.com

onsemi Website: www.onsemi.com

TECHNICAL SUPPORT

North American Technical Support:

Voice Mail: 1 800-282-9855 Toll Free USA/Canada

Phone: 011 421 33 790 2910

Europe, Middle East and Africa Technical Support:

Phone: 00421 33 790 2910

For additional information, please contact your local Sales Representative