

Features

- Low leakage current
- Operating voltage: 5V
- Low clamping voltage
- JEDEC SOT-353 package
- Complies with following standards:
 - IEC 61000-4-2 (ESD) immunity test
 - Air discharge: $\pm 30\text{kV}$
 - Contact discharge: $\pm 30\text{kV}$
 - IEC61000-4-5 (Lightning) 8A (8/20 μs)
- RoHS Compliant

Dimensions SOT-353

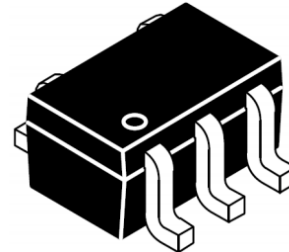

Applications

- Peripherals
- Industrial Equipment
- Notebook Computers
- Portable Instrumentation
- Microprocessor Based Equipment
- Cell Phone Handsets and Accessories
- Personal Digital Assistants (PDAs) and Pagers

Pin Configuration

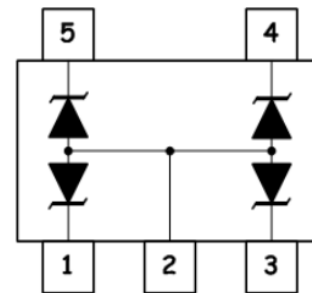

Mechanical Characteristics

- Package: SOT-353
- Lead Finish: Matte Tin
- Case Material: “Green” Molding Compound.
- Moisture Sensitivity: Level 3 per J-STD-020
- Terminal Connections: See Diagram Below
- Marking Information: See Below

Absolute Maximum Ratings (T_{amb}=25°C unless otherwise specified)

Parameter	Symbol	Value	Unit
Peak Pulse Power (8/20 μs)	P _{pp}	100	W
ESD per IEC 61000-4-2 (Air)	V _{ESD}	± 30	Kv
ESD per IEC 61000-4-2 (Contact)		± 30	
Operating Temperature Range	T _J	-55 to +125	°C
Storage Temperature Range	T _{STJ}	-55 to +150	°C

Electrical Characteristics (TA=25°C unless otherwise specified)

Part Number	Device Marking	V _{RWM} (V)	V _{BR} (V)	I _T (mA)	V _C @1A	V _C		I _R μA (Max)	C (Pf) (Typ.)
						(Max)	(@A)		
SDA33W5	F05	3	4.5	1	8	15.3	4	5	40

Typical Performance Characteristics ($T_A=25^\circ\text{C}$ unless otherwise Specified)

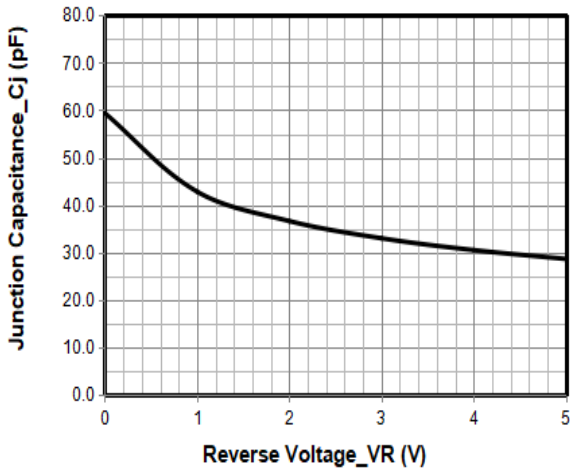

Junction Capacitance vs. Reverse Voltage

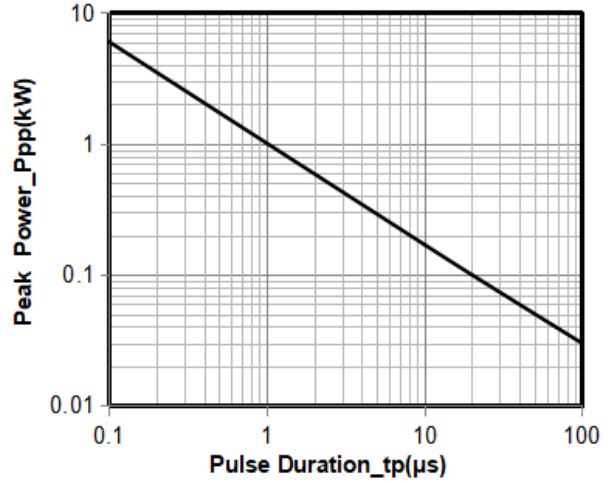

Peak Pulse Power vs. Pulse Time

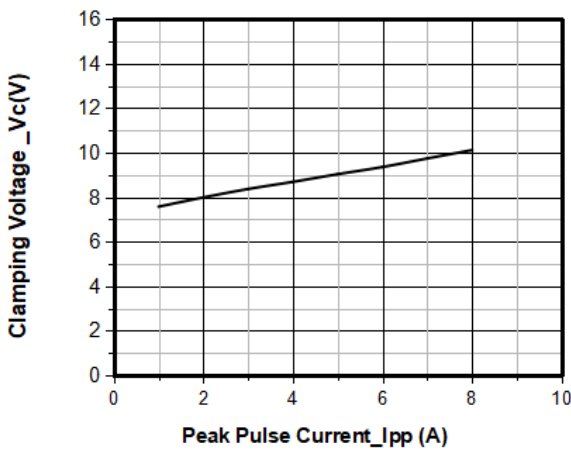

Clamping Voltage vs. Peak Pulse Current

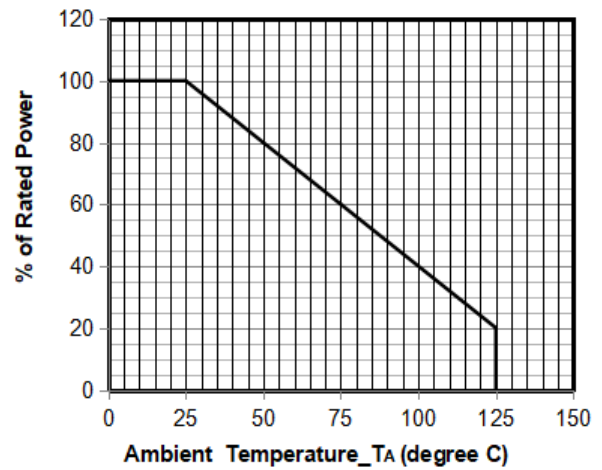

Power Derating Curve

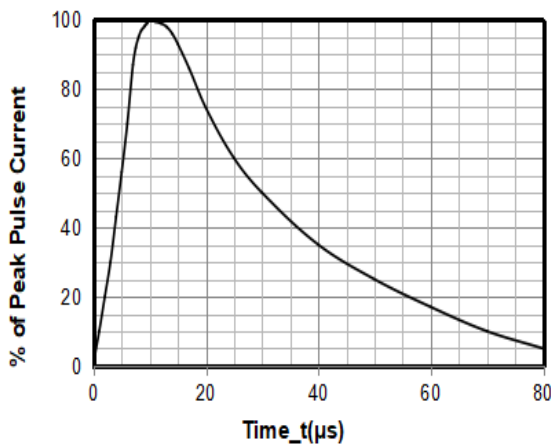

8 X 20μs Pulse Waveform

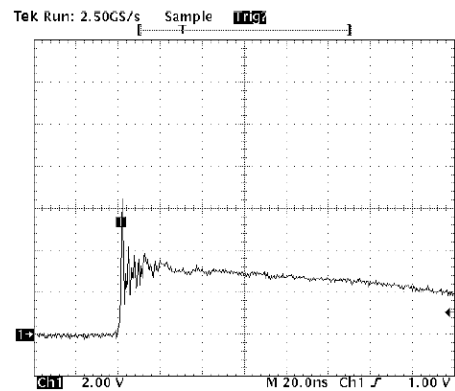

Note: Data is taken with a 10x attenuator

ESD Clamping Voltage

8 kV Contact per IEC61000-4-2

SOT-353 Package Outline & Dimensions

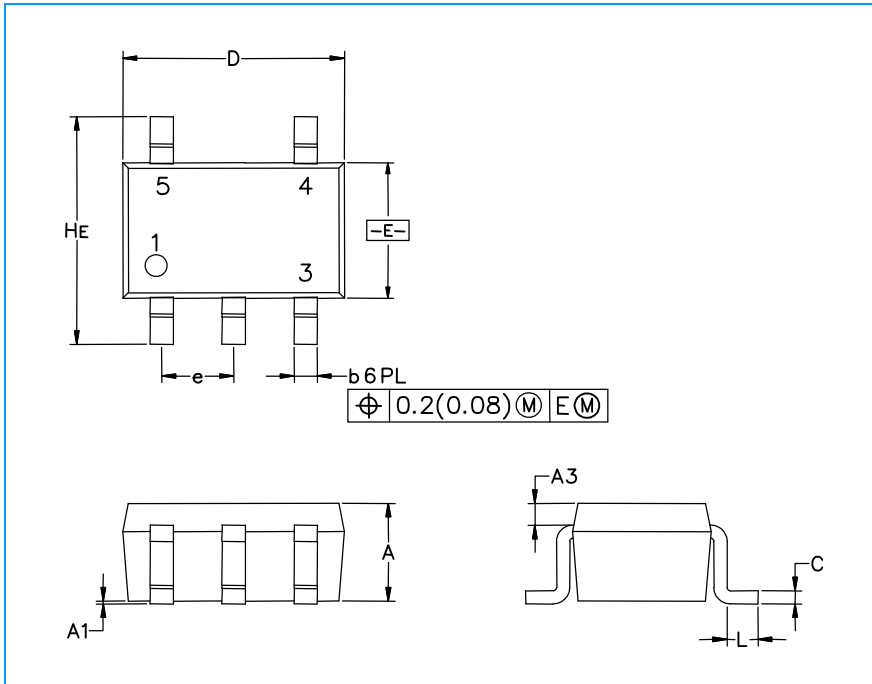

Symbol	Inches			Millimeters		
	Min.	Nom.	Max.	Min.	Nom.	Max.
A	0.031	0.037	0.043	0.80	0.95	1.10
A1	0.000	0.002	0.004	0.00	0.05	0.10
A3	0.08 REF			0.2 REF		
b	0.004	0.008	0.012	0.10	0.21	0.30
C	0.004	0.005	0.010	0.10	0.14	0.25
D	0.070	0.078	0.086	1.80	2.00	2.20
E	0.045	0.049	0.053	1.15	1.25	1.35
e	0.026 BSC			0.65 BSC		
L	0.004	0.008	0.012	0.10	0.20	0.30
HE	0.078	0.082	0.086	2.00	2.10	2.20

Soldering Footprint

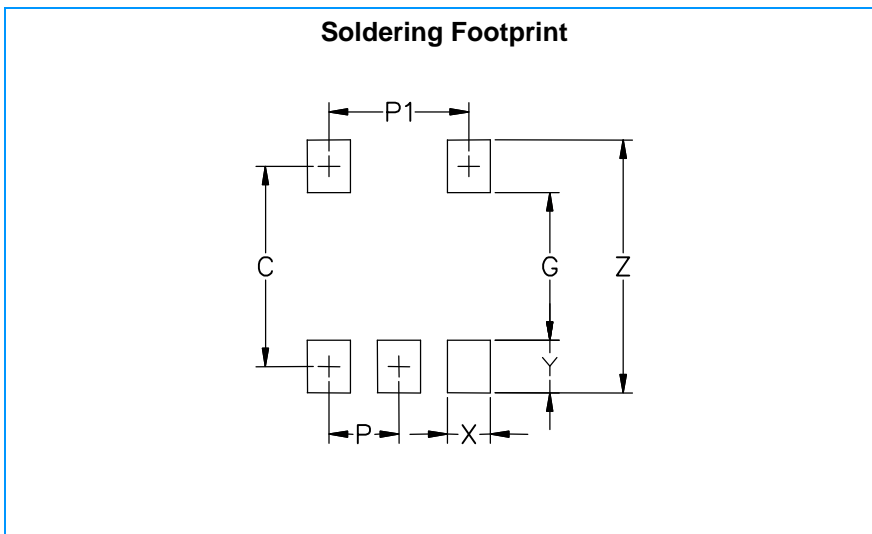

Symbol	Inches	Millimeters
C	0.0748	1.9
G	0.055	1.40
P	0.025	0.65
P1	0.051	1.30
X	0.0157	0.40
Y	0.019	0.50
Z	0.0945	2.4