

P.C.B LAYOUT

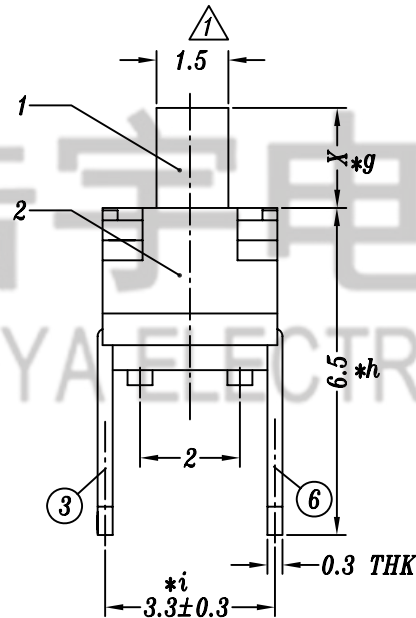
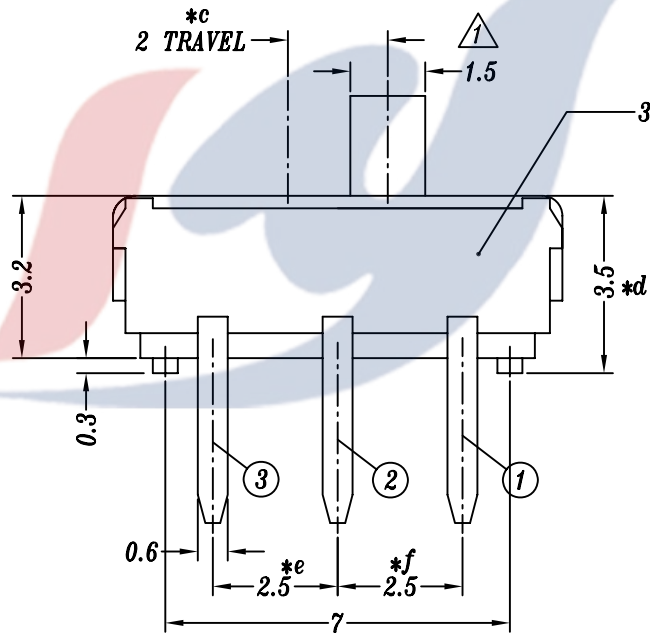

SPECIFICATION

1. Rating: DC 12V 0.3A
2. Travel: 2 mm
3. Function: 2P2T
4. Contact Resistance: <70mΩMAX
5. Operating Force: 200±80gf, 300±100gf
6. Life test: 10,000 cycles

KNOB X=1.5 ,2, 3, 4, 5, 5.5mm

G2: 胶柄长3mm
B: 胶柄黑色

					TOLERANCE							
					UNLESS SPECIFIED		A1	2018.06.27	取消部份尺寸重点管控		GYW	
					UP TO 5mm: ±0.1	ANGULAR	A0	2017.07.21	首次发行		GYW	
					ABOVE 5mm: ±0.2	±1°	NO	DATE	REVISIONS		BY	APPD
4	MK22D10 SPRING	PBS	2	NATURAL	TITLE:MINI SLIDE SWITCH			UNIT : MM	ROHS	DWN		
3	MS22D16 CASE	PA6T/0.3mm BRASS STRIP	1	BLACK/Ag(Ni) PLATED	MODEL:MS-22D16G3-B 弹线			SCALE: 6:1	COMPLIANT	CHK'D		
2	MS22D16 COVER	0.2mm SUS	1	WASHING	HAOYU(HONGKONG)LIMITED 皓宇(香港)有限公司			APPD		PRO.AGL:		
1	MS22D16 KNOB	PA66/PA46/PA6T	1	WHITE/BLACK								
NO.	PART NAME	MATERIAL	QTY	FINISHING						REV :A1		