

## ASMT-YTD7-0AA02

### Tricolor PLCC6 White Surface LED

---

#### Description

This family of SMT LEDs is packaged in the form of PLCC-6 with a separate heat path for each LED die, enabling it to be driven at a higher current.

Individually addressable pin-outs give higher flexibility in circuitry design. With closely matched radiation pattern along the package's X-axis, these LEDs are suitable for indoor full color display applications.

For easy pick-and-place, the LEDs are shipped in tape and reel. Every reel is shipped from a single intensity and color bin for better uniformity.

These LEDs are compatible with reflow soldering process.

**CAUTION!** These LEDs are Class 1C ESD sensitive. Please observe appropriate precautions during handling and processing. Refer to Broadcom<sup>®</sup> Application Note AN-1142 for additional details.

**CAUTION!** Customers should keep the LED in the moisture barrier bag (MBB) when not in use because prolonged exposure to the environment might cause the silver-plated leads to tarnish, which might cause difficulties in soldering.

#### Features

- Standard PLCC-6 package (Plastic Leaded Chip Carrier) with individual addressable pin-out for higher flexibility of driving configuration
- LED package with diffused silicone encapsulation
- Using AlInGaP and InGaN dice technologies
- Typical viewing angle 110°
- Compatible with reflow soldering process
- JEDEC MSL 3
- Water-Resistance (IPX6, see note) per IEC 60529:2001

**NOTE:** The test is conducted at the component level by mounting the components on the PCB with proper porting to protect the leads. Customers should perform the necessary tests on the components for their final applications.

#### Applications

- Full color display

## Package Dimensions

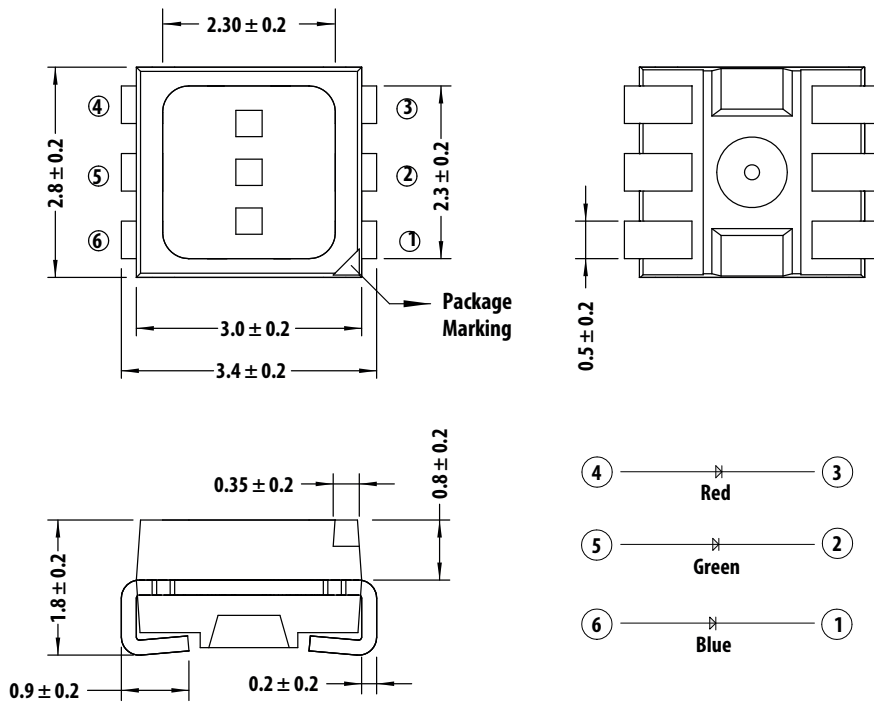

## Lead Configuration

1	Cathode (Blue)
2	Cathode (Green)
3	Cathode (Red)
4	Anode (Red)
5	Anode (Green)
6	Anode (Blue)

### NOTE:

1. All dimensions are in millimeters (mm).
2. Unless otherwise specified, tolerance is  $\pm 0.20$  mm.
3. Encapsulation = silicone.
4. Terminal finish = silver plating.

## Absolute Maximum Ratings

$T_J = 25^\circ\text{C}$ .

Parameter	Red	Green and Blue	Unit
DC forward current <sup>a</sup>	50	25	mA
Peak forward current <sup>b</sup>	100	100	mA
Power dissipation	125	90	mW
Maximum junction temperature $T_J$ max	110		$^\circ\text{C}$
Operating temperature range	-40 to +100		$^\circ\text{C}$
Storage temperature range	-40 to +100		$^\circ\text{C}$

a. Derate linearly as shown in [Figure 7](#) to [Figure 10](#).

b. Duty Factor = 10%, frequency = 1 kHz.

## Optical Characteristics

$T_J = 25^\circ\text{C}$ .

Color	Luminous Intensity, $I_V$ (mcd) @ $I_F = 20\text{ mA}^a$			Dominant Wavelength, $\lambda_d$ (nm) @ $I_F = 20\text{ mA}^b$			Peak Wavelength, $\lambda_p$ (nm) @ $I_F = 20\text{ mA}$	Viewing Angle, $2\theta_{1/2}$ ( $^\circ$ ) <sup>c</sup>	Test Current (mA)
	Min.	Typ.	Max.	Min.	Typ.	Max.	Typ.	Typ.	
Red	560	650	1125	617	623	627	630	120	20
Green	1400	1900	2850	525	529	537	522	120	
Blue	285	384	560	465	469	475	465	120	

a. The luminous intensity  $I_V$  is measured at the mechanical axis of the LED package at a single current pulse condition. The actual peak of the spatial radiation pattern may not be aligned with the axis.

b. The dominant wavelength is derived from the CIE Chromaticity Diagram and represents the perceived color of the device.

c.  $\theta_{1/2}$  is the off-axis angle where the luminous intensity is  $1/2$  the peak intensity.

## Electrical Characteristics

$T_J = 25^\circ\text{C}$ .

Color	Forward Voltage, $V_F$ (V) @ $I_F = 20\text{ mA}^a$			Reverse Voltage, $V_R$ (V) @ $I_R = 100\ \mu\text{A}^b$	Reverse Voltage, $V_R$ (V) @ $I_R = 10\ \mu\text{A}^b$	Thermal Resistance, $R_{\theta J-S}$ ( $^\circ\text{C}/\text{W}$ )	
	Min.	Typ.	Max.	Min.	Min.	1 Chip On	3 Chips On
Red	1.8	2.1	2.5	4.0	—	280	330
Green	2.6	3.1	3.4	—	4.0	240	357
Blue	2.6	3.1	3.4	—	4.0	240	357

a. Tolerance =  $\pm 0.1\text{V}$ .

b. Indicates product final testing condition. Long-term reverse bias is not recommended.

# Part Numbering System

A S M T - Y T D 7 - 0 A A 0 2

x<sub>1</sub>

x<sub>2</sub> x<sub>3</sub> x<sub>4</sub> x<sub>5</sub>

Code	Description	Option	
x <sub>1</sub>	Package type	D	White surface
x <sub>2</sub>	Minimum intensity bin	A	Red: bin U2
			Green: bin W2
			Blue: bin T1
			Red: bin U2, V1, V2
			Green: bin W2, X1, X2
			Blue: bin T1, T2, U1
x <sub>3</sub>	Number of intensity bins	A	3 intensity bins from minimum
x <sub>4</sub>	Color bin combination	0	Red: full distribution
			Green: bin A, B, C
			Blue: bin A, B, C, D
x <sub>5</sub>	Test option	2	Test current = 20 mA

## Bin Information

### Intensity Bins (CAT)

Bin ID	Luminous Intensity (mcd)	
	Min.	Max.
T1	285	355
T2	355	450
U1	450	560
U2	560	715
V1	715	900
V2	900	1125
W1	1125	1400
W2	1400	1800
X1	1800	2240
X2	2240	2850

Tolerance:  $\pm 12\%$

### Color Bins (BIN) – Green

Bin ID	Dominant Wavelength (nm)		Chromaticity Coordinate (for Reference)	
	Min.	Max.	Cx	Cy
A	525.0	531.0	0.1142	0.8262
			0.1624	0.7178
			0.2001	0.6983
			0.1625	0.8012
B	528.0	534.0	0.1387	0.8148
			0.1815	0.7089
			0.2179	0.6870
			0.1854	0.7867
C	531.0	537.0	0.1625	0.8012
			0.2001	0.6983
			0.2353	0.6747
			0.2077	0.7711

Tolerance:  $\pm 1$  nm.

### Color Bins (BIN) – Red

Bin ID	Dominant Wavelength (nm)		Chromaticity Coordinate (for Reference)	
	Min.	Max.	Cx	Cy
—	617.0	627.0	0.6850	0.3149
			0.6815	0.3150
			0.7000	0.2966
			0.7037	0.2962

Tolerance:  $\pm 1$  nm.

### Color Bins (BIN) – Blue

Bin ID	Dominant Wavelength (nm)		Chromaticity coordinate (for Reference)	
	Min.	Max.	Cx	Cy
A	465.0	469.0	0.1355	0.0399
			0.1751	0.0986
			0.1680	0.1094
			0.1267	0.0534
B	467.0	471.0	0.1314	0.0459
			0.1718	0.1034
			0.1638	0.1167
			0.1215	0.0626
C	469.0	473.0	0.1267	0.0534
			0.1680	0.1094
			0.1593	0.1255
D	471.0	475.0	0.1158	0.0736
			0.1215	0.0626
			0.1638	0.1167
			0.1543	0.1361
			0.1096	0.0868

Tolerance:  $\pm 1$  nm.

Figure 1: Relative Intensity vs. Wavelength

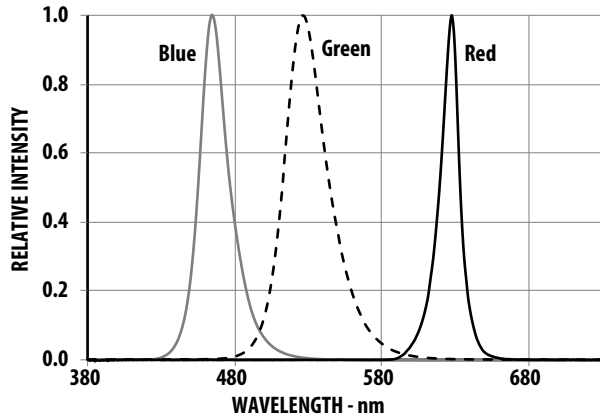

Figure 2: Forward Current vs. Forward Voltage

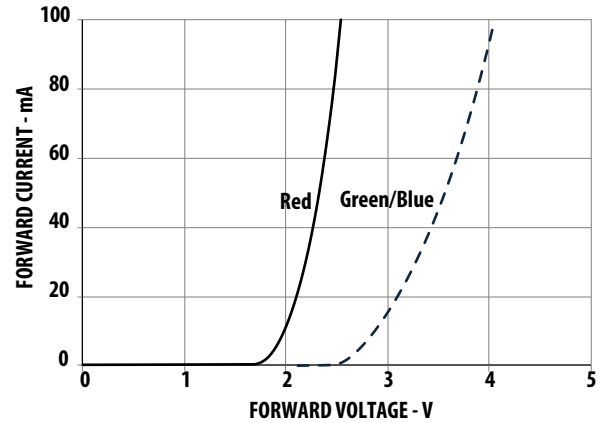

Figure 3: Relative Intensity vs. Forward Current

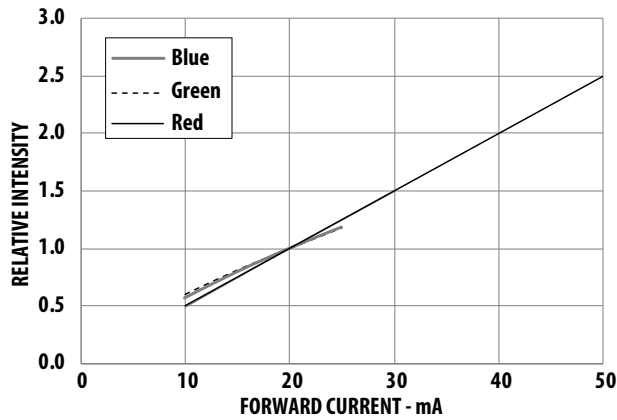

Figure 4: Dominant Wavelength Shift vs. Forward Current

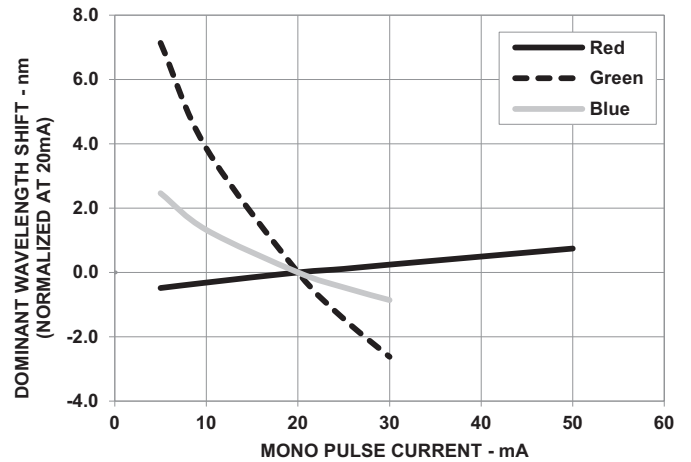

Figure 5: Relative Intensity vs. Junction Temperature

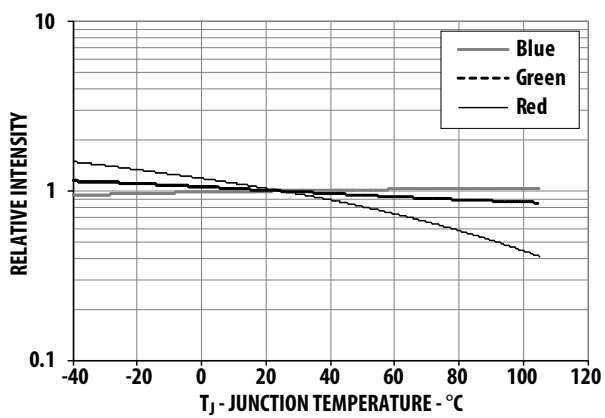

Figure 6: Forward Voltage vs. Junction Temperature

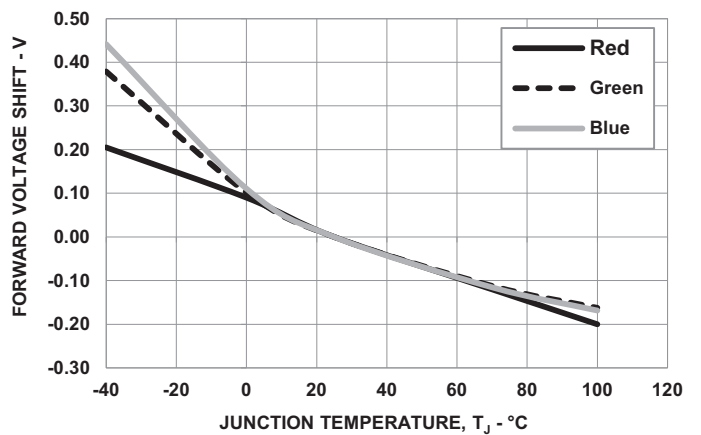

Figure 7: Maximum Forward Current vs. Temperature for Red (1 Chip On)

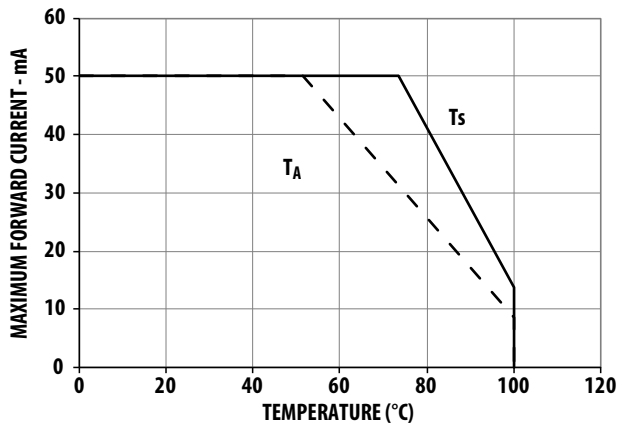

Figure 8: Maximum Forward Current vs. Temperature for Red (3 Chips On)

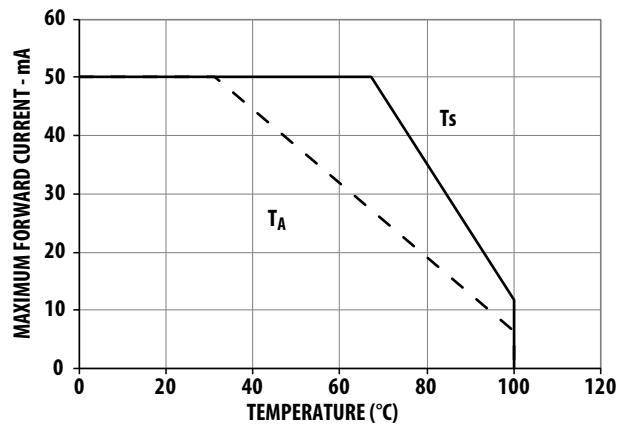

Figure 9: Maximum Forward Current vs. Temperature for Green and Blue (1 Chip On)

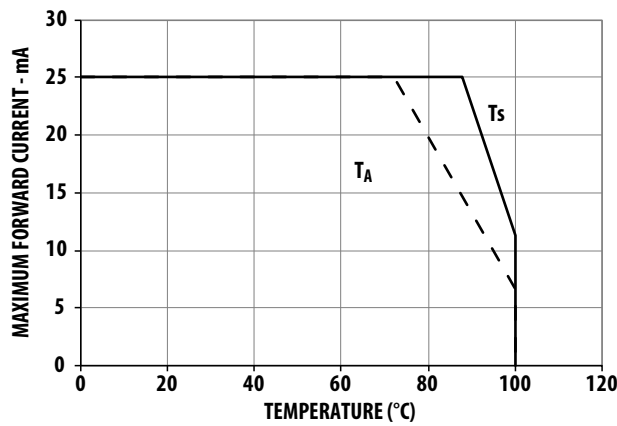
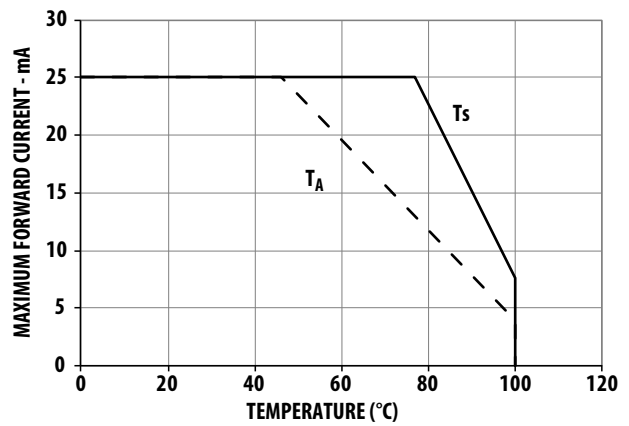

Figure 10: Maximum Forward Current vs. Temperature for Green and Blue (3 Chips On)



**NOTE:** Maximum forward current graphs based on ambient temperature,  $T_A$  are with reference to thermal resistance  $R_{\theta J-A}$  as follows. For more details, see [Thermal Management](#).

Condition	Thermal Resistance from LED Junction to Ambient, $R_{\theta J-A}$ (°C/W)	
	Red	Green and Blue
1 chip on	450	410
3 chips on	630	690

Figure 11: Radiation Pattern Along X-Axis of the Package

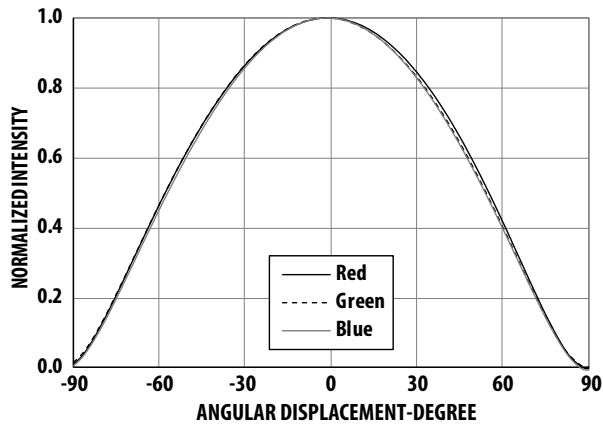

Figure 12: Radiation Pattern Along Y-Axis of the Package

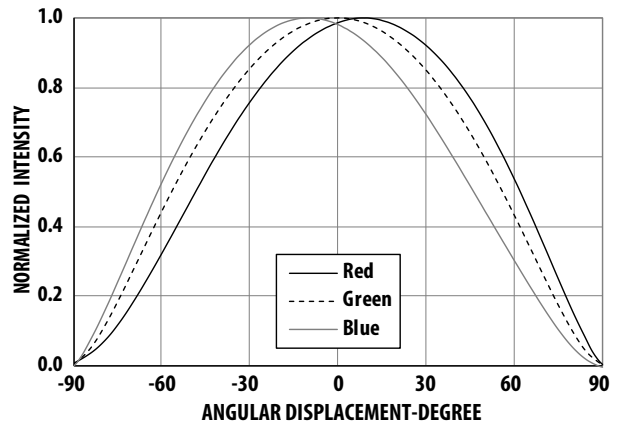

Figure 13: Illustration of Package Axis for Radiation Pattern

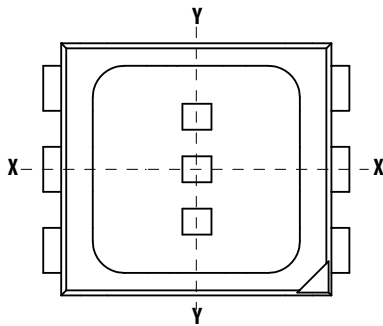
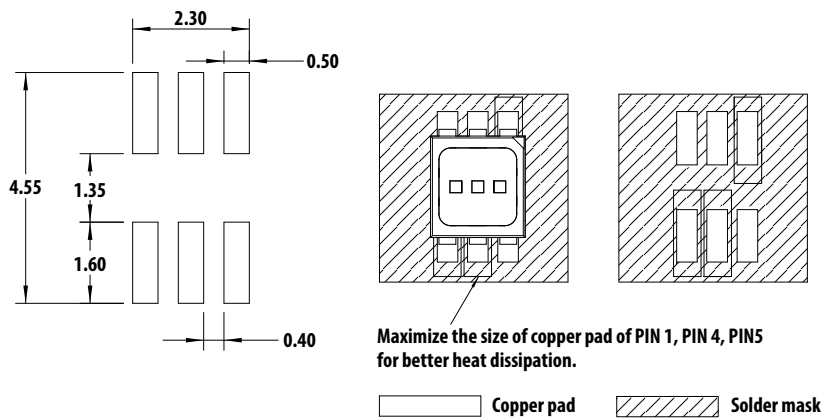
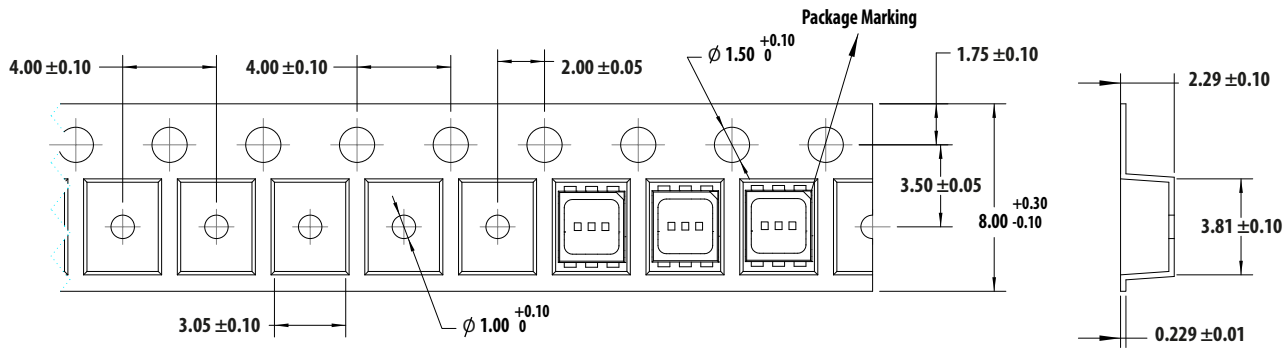

Figure 14: Recommended Soldering Land Pattern





**Figure 15: Carrier Tape Dimensions**



**Figure 16: Reeling Orientation**

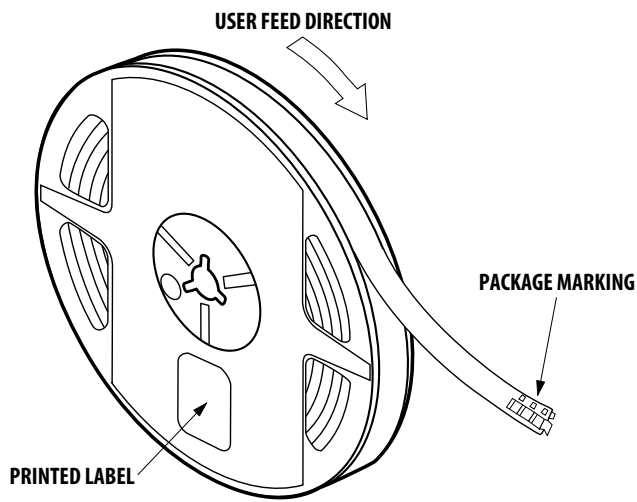
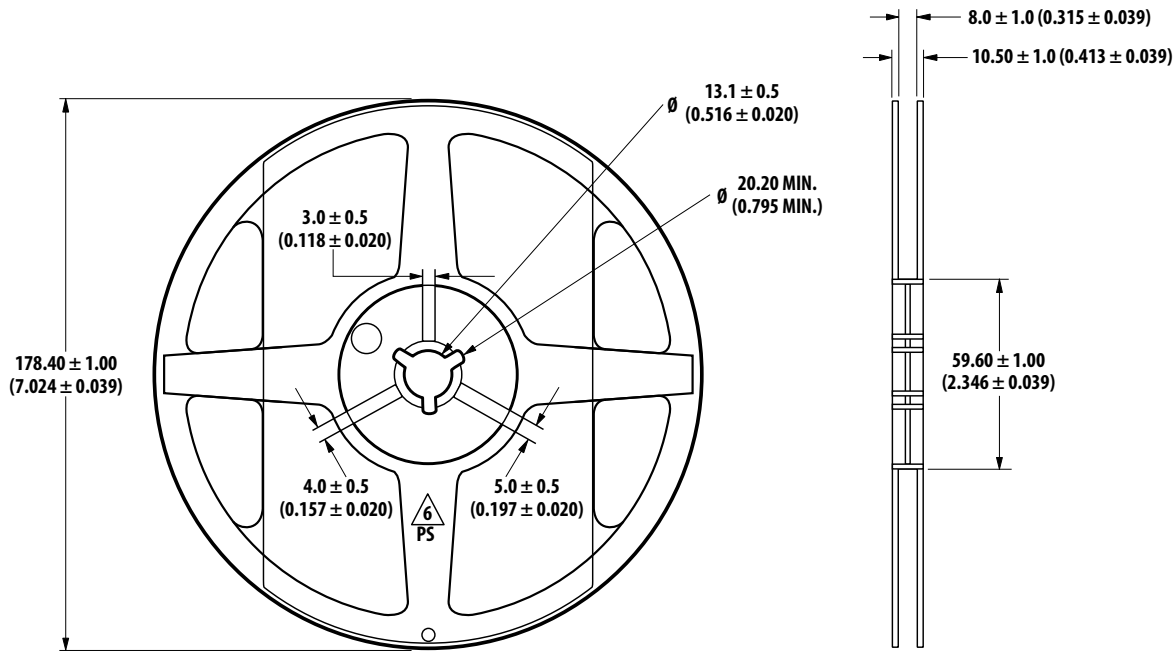

Figure 17: Reel Dimensions







# Packing Label

## (i) Standard label (attached on moisture barrier bag)

<p>(1P) Item: <b>Part Number</b></p> 		<p><b>AvAGO</b> TECHNOLOGIES STANDARD LABEL LS0002 RoHS Compliant Halogen Free e4 Max Temp 260C MSL3</p>	
<p>(1T) Lot: <b>Lot Number</b></p> 		<p>(Q) QTY: <b>Quantity</b></p> 	
<p>LPN:</p> 		<p>CAT: <b>Intensity Bin</b></p> 	
<p>(9D)MFG Date: <b>Manufacturing Date</b></p> 		<p>BIN: <b>Color Bin</b></p> 	
<p>(P) Customer Item:</p> 			
<p>(V) Vendor ID:</p> 		<p>(9D) Date Code: <b>Date Code</b></p> 	
<p>DeptID:</p> 		<p>Made In: <b>Country of Origin</b></p> 	

## (ii) Baby label (attached on plastic reel)

<p>(1P) PART #: <b>Part Number</b></p> 		<p><b>AvAGO</b> TECHNOLOGIES BABY LABEL COSB001B V0.0</p>	
<p>(1T) LOT #: <b>Lot Number</b></p> 			
<p>(9D)MFG DATE: <b>Manufacturing Date</b></p> 		<p>QUANTITY: <b>Packing Quantity</b></p> 	
<p>C/O: <b>Country of Origin</b></p>		<p>(9D): DATE CODE:</p>	
<p>(1T) TAPE DATE:</p> 		<p>D/C: <b>Date Code</b> VF:</p>	
		<p>CAT: <b>INTENSITY BIN</b></p>	
		<p>BIN: <b>COLOR BIN</b></p>	

Example of luminous intensity (lv) bin information on label:

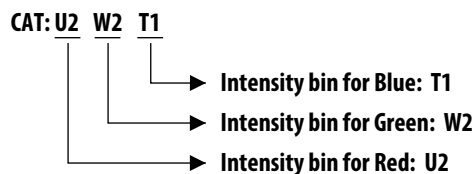

Example of color bin information on label:

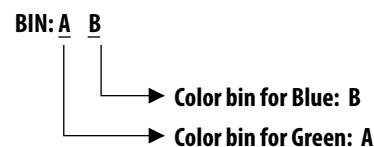

**NOTE:** No color bin ID exists for the Red color because there is only one range (see [Bin Information](#)).

# Soldering

Recommended reflow soldering condition.

## (i) Leaded Reflow Soldering

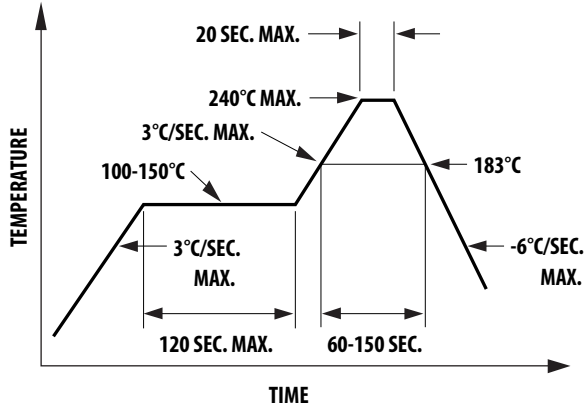

- Do not perform reflow soldering more than twice. Observe the necessary precautions for handling moisture-sensitive devices as stated in the following section.
- Recommended board reflow direction is as follows.

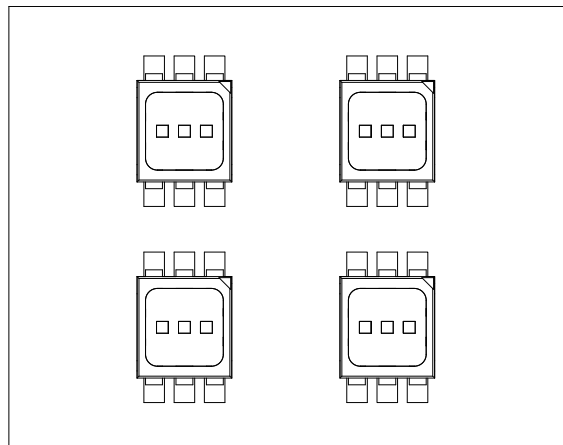

## (ii) Lead-Free Reflow Soldering

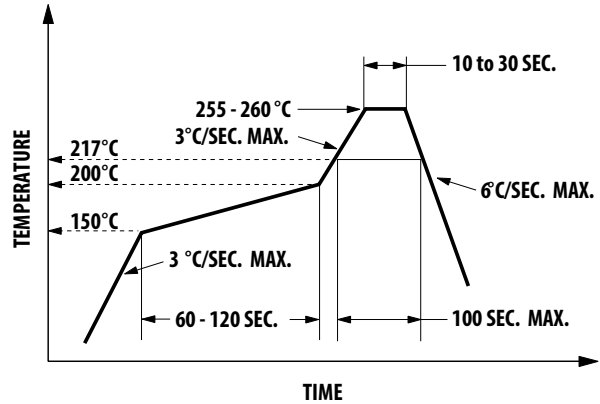

- Do not apply any pressure or force on the LED during reflow and after reflow when the LED is still hot.
- Use reflow soldering to solder the LED. Use hand soldering for rework only if this is unavoidable, and it must be strictly controlled to the following conditions:
  - Soldering iron tip temperature = 320°C maximum
  - Soldering duration = 3 seconds maximum
  - Number of cycles = 1 only
  - Power of soldering iron = 50W maximum
- Do not touch the LED body with a hot soldering iron except the soldering terminals because it might damage the LED.
- For de-soldering, use a double flat tip.
- Confirm beforehand whether hand soldering will affect the functionality and performance of the LED.

## Precautionary Notes

### Handling Precautions

The encapsulation material of the LED is made of silicone for better product reliability. Compared to epoxy encapsulant that is hard and brittle, silicone is softer and flexible. Observe special handling precautions during assembly of silicone encapsulated LED products. Failure to comply might lead to damage and premature failure of the LED. Refer to Application Note AN5288, *Silicone Encapsulation for LED: Advantages and Handling Precautions* for more information.

- Do not poke sharp objects into the silicone encapsulant. Sharp objects, such as tweezers or syringes, might apply excessive force or even pierce through the silicone and cause failures to the LED die or wire bond.
- Do not touch the silicone encapsulant. Uncontrolled forces acting on the silicone encapsulant might result in excessive stress on the wire bond. Hold the LED only by the body.
- Do not stack assembled PCBs together. Use an appropriate rack to hold the PCBs.
- The surface of the silicone material attracts dust and dirt easier than epoxy due to its surface tackiness. To remove foreign particles on the surface of silicone, use a cotton bud with isopropyl alcohol (IPA). During cleaning, rub the surface gently without putting pressure on the silicone. Ultrasonic cleaning is not recommended.
- For automated pick-and-place, Broadcom has tested the following nozzle size to work with this LED. However, due to the possibility of variations in other parameters, such as pick and place machine maker/model and other settings of the machine, verify that the selected nozzle will not cause damage to the LED.

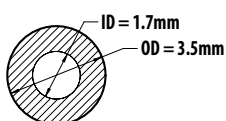
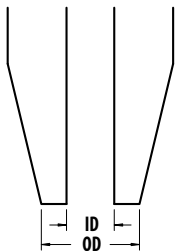

### Handling of Moisture-Sensitive Devices

This product has a Moisture Sensitive Level 3 rating per JEDEC J-STD-020. Refer to Broadcom Application Note AN5305, *Handling of Moisture Sensitive Surface Mount Devices*, for additional details and a review of proper handling procedures.

- Before use:
  - An unopened moisture barrier bag (MBB) can be stored at  $< 40^{\circ}\text{C} / 90\% \text{RH}$  for 12 months. If the actual shelf life has exceeded 12 months and the humidity indicator card (HIC) indicates that baking is not required, it is safe to reflow the LEDs per the original MSL rating.
  - Do not open the MBB prior to assembly (for example, for IQC).
- Control after opening the MBB:
  - Read the HIC immediately upon opening the MBB.
  - Keep the LEDs at  $< 30^{\circ}\text{C} / 60\% \text{RH}$  at all times, and all high temperature-related processes, including soldering, curing or rework, must be completed within 168 hours.
- Control for unfinished reel:
  - Store unused LEDs in a sealed MBB with desiccant or desiccator at  $< 5\% \text{RH}$ .
- Control of assembled boards:
  - If the PCB soldered with the LEDs is to be subjected to other high-temperature processes, store the PCB in a sealed MBB with desiccant or desiccator at  $< 5\% \text{RH}$  to ensure that all LEDs have not exceeded their floor life of 168 hours.
- Baking is required if:
  - The HIC indicator is not BROWN at 10% and is AZURE at 5%.
  - The LEDs are exposed to condition of  $> 30^{\circ}\text{C} / 60\% \text{RH}$  at any time.
  - The LED floor life exceeded 168 hours.

The recommended baking condition is:  $60^{\circ}\text{C} \pm 5^{\circ}\text{C}$  for 20 hours.

Baking should only be done once.

### ■ Storage

The soldering terminals of these Broadcom LEDs are silver plated. If the LEDs are exposed too long in the ambient environment, the silver plating might become oxidized and, thus, affect its solderability performance. As such, keep unused LEDs in a sealed MBB with desiccant or in desiccator at <5 % RH.

## Application Precautions

- The drive current of the LED must not exceed the maximum allowable limit across temperature as stated in the data sheet. Constant current driving is recommended to ensure consistent performance.
- LEDs exhibit slightly different characteristics at different drive currents, which might result in larger variations in their performance (that is, intensity, wavelength, and forward voltage). Set the application current as close as possible to the test current to minimize these variations.
- The LED is not intended for reverse bias. Use other appropriate components for such purposes. When driving the LED in matrix form, make sure that the reverse bias voltage does not exceed the allowable limit of the LED.
- Do not use the LED in the vicinity of material with sulfur content or in an environment of high gaseous sulfur compound and corrosive elements. Examples of material that might contain sulfur are rubber gaskets, RTV (room temperature vulcanizing) silicone rubber, rubber gloves, and so on. Prolonged exposure to such an environment might affect the optical characteristics and product life.
- Avoid a rapid change in ambient temperature, especially in high humidity environments, because this will cause condensation on the LED.
- Although the LED is rated as IPx6 according to IEC60529, the degree of protection provided by enclosure, the test condition might not represent actual exposure during application. If the LED is intended to be used in an outdoor or a harsh environment, protect the LED against damage caused by rain water, dust, oil, corrosive gases, external mechanical stress, and so on.

## Thermal Management

Optical, electrical, and reliability characteristics of the LED are affected by temperature. Keep the junction temperature ( $T_J$ ) of the LED below allowable limits at all times.  $T_J$  can be calculated as follows:

$$T_J = T_A + R_{\theta J-A} \times I_F \times V_{Fmax}$$

where:

$T_A$  = Ambient temperature ( $^{\circ}\text{C}$ )

$R_{\theta J-A}$  = Thermal resistance from LED junction to ambient ( $^{\circ}\text{C}/\text{W}$ )

$I_F$  = Forward current (A)

$V_{Fmax}$  = Maximum forward voltage (V)

The complication of using this formula lies in  $T_A$  and  $R_{\theta J-A}$ . Actual  $T_A$  is sometimes subjective and hard to determine.  $R_{\theta J-A}$  varies from system to system depending on design and is usually not known.

Another way of calculating  $T_J$  is by using the solder point temperature  $T_S$  as follows:

$$T_J = T_S + R_{\theta J-S} \times I_F \times V_{Fmax}$$

where:

$T_S$  = LED solder point temperature as shown in the following illustration ( $^{\circ}\text{C}$ )

$R_{\theta J-S}$  = Thermal resistance from junction to solder point ( $^{\circ}\text{C}/\text{W}$ )

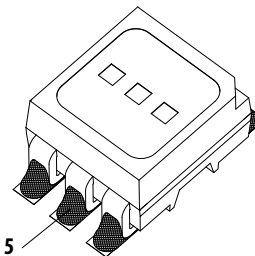

$T_S$  can be measured easily by mounting a thermocouple on the soldering joint as shown in preceding illustration, while  $R_{\theta J-S}$  is provided in the data sheet. Verify the  $T_S$  of the LED in the final product to ensure that the LEDs are operated within all maximum ratings stated in the data sheet.

## Eye Safety Precautions

LEDs may pose optical hazards when in operation. Do not look directly at operating LEDs because it might be harmful to the eyes. For safety reasons, use appropriate shielding or personal protective equipment.

## Disclaimer

Broadcom's products are not specifically designed, manufactured, or authorized for sale as parts, components, or assemblies for the planning, construction, maintenance, or direct operation of a nuclear facility or for use in medical devices or applications. Customers are solely responsible, and waive all rights to make claims against Broadcom or its suppliers, for all loss, damage, expense, or liability in connection with such use.

Broadcom, the pulse logo, Connecting everything, Avago Technologies, Avago, and the A logo are among the trademarks of Broadcom and/or its affiliates in the United States, certain other countries, and/or the EU.

Copyright © 2014–2018 Broadcom. All Rights Reserved.

The term "Broadcom" refers to Broadcom Inc. and/or its subsidiaries. For more information, please visit [www.broadcom.com](http://www.broadcom.com).

Broadcom reserves the right to make changes without further notice to any products or data herein to improve reliability, function, or design. Information furnished by Broadcom is believed to be accurate and reliable. However, Broadcom does not assume any liability arising out of the application or use of this information, nor the application or use of any product or circuit described herein, neither does it convey any license under its patent rights nor the rights of others.

