



MD85XX is a high voltage (up to 40V) ultra-low quiescent current low dropout voltage regulator (LDO) manufactured in CMOS processes. It can deliver up to 300mA of current while consuming only 1.5uA of quiescent current. It consists of a reference voltage generator, an error amplifier, a current foldback circuit, and a phase compensation circuit plus a driver transistor. The MD85XX is designed specifically for applications where very-low  $I_Q$  is a critical parameter. This device

maintains low quiescent current consumption even in dropout mode to further increase the battery life. When in shutdown or disabled mode, the device consumes less than 100-nA  $I_Q$  even with input voltage of 40V that helps increase the shelf life of the battery.

### ■ Features

- Ultra-low Quiescent Current: 1.5uA
- Maximum Input Voltage: 40V
- Output Voltage Highly Accurate:  $\pm 2\%$
- Maximum Output Current: 300mA
- Dropout Voltage: 4mV@ $I_{OUT}=1mA$
- Temperature Stability:  $\pm 50ppm/^{\circ}C$
- ON/OFF Logic = Enable High
- Protections Circuits: Current Limiter, Foldback, Thermal shutdown
- Output Capacitor: Low ESR Ceramic Capacitor Compatible

### ■ Applications

- Smart wearer
- Long-life battery-powered devices
- Portable mobile devices, such as mobile phones, cameras, and so on
- Wireless communication equipment

### ■ Typical Applications

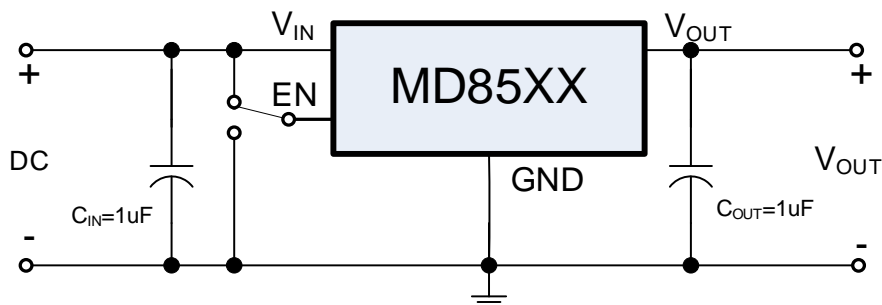

### ■ Notes on Use

1. Input Capacitor ( $C_{IN}$ ): 1 $\mu$ F above.
2. Output Capacitor ( $C_{OUT}$ ): 1 $\mu$ F above.
3. If the output capacitor is 1uF, it is recommended that the withstand voltage value is not less than 25V, and the capacitance value change rate at high temperature or low temperature does not exceed 20%.



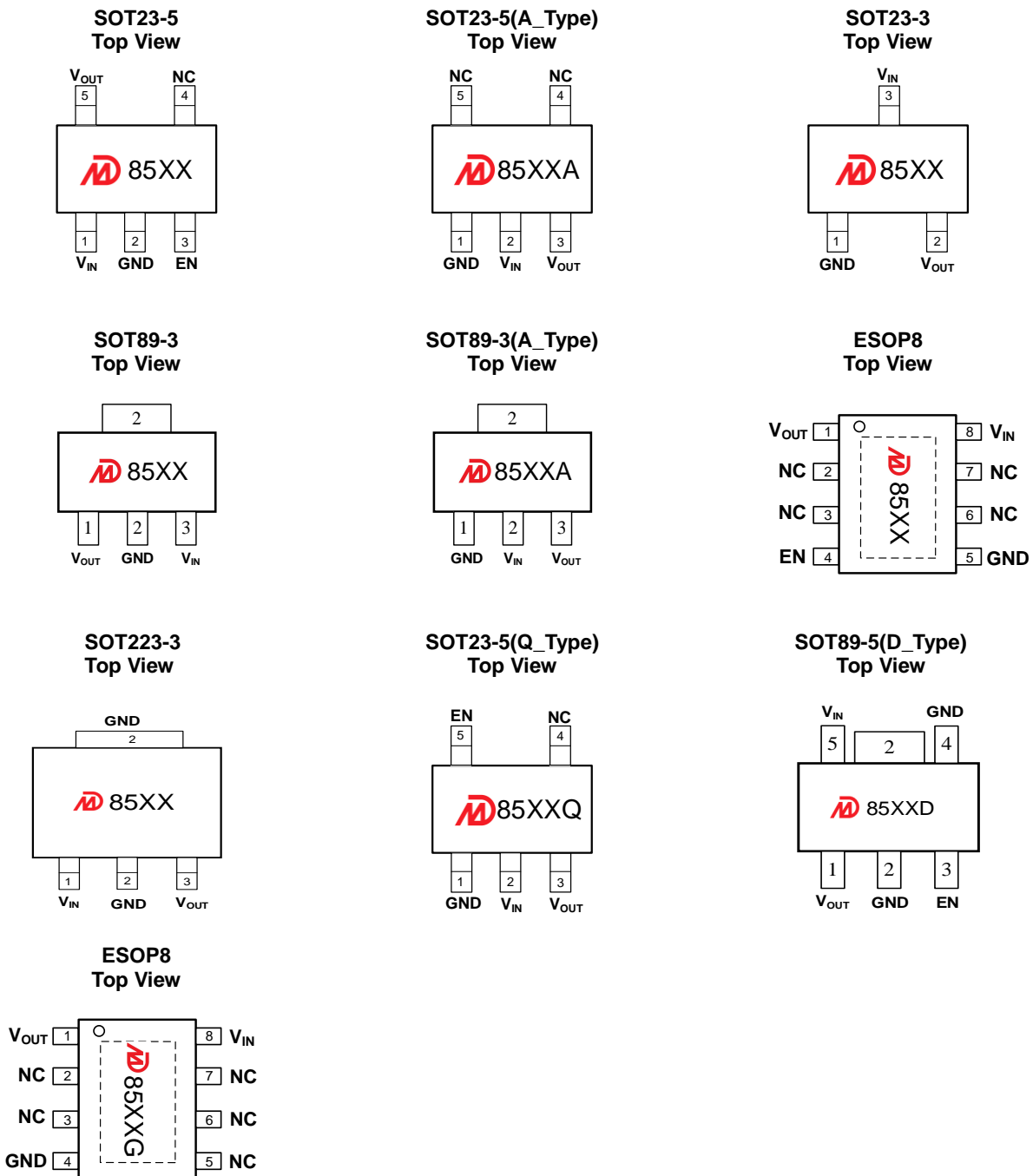

































## Pin Configuration and Functions





















### Pin Functions

NAME	DESCRIPTION
$V_{IN}$	Power Input Pin.
EN	Enable pin. Drive this pin high to enable the device. Drive this pin low to put the device into low current shutdown.
$V_{OUT}$	Regulated output voltage pin
GND	Ground
Thermal pad	The thermal pad is electrically connected to the GND node. Connect this pad to the GND plane for improved thermal performance.
NC	No internal connection

**■ Product Selections**

Product Name	V <sub>OUT</sub> (V)	Package	Ordering Name	Marking	Package Information
MD8518	1.8	SOT23-5L	MD85E18QC3	 8518	Tape and Reel, 3000pcs
MD8525	2.5	SOT23-5L	MD85E25QC3	 8525	
MD8528	2.8	SOT23-5L	MD85E28QC3	 8528	
MD8530	3.0	SOT23-5L	MD85E30QC3	 8530	
MD8533	3.3	SOT23-5L	MD85E33QC3	 8533	
MD8536	3.6	SOT23-5L	MD85E36QC3	 8536	
MD8550	5.0	SOT23-5L	MD85E50QC3	 8550	
MD8525A	2.5	SOT23-5L	MD85A25QC3	 8525A	
MD8530A	3.0	SOT23-5L	MD85A30QC3	 8530A	
MD8533A	3.3	SOT23-5L	MD85A33QC3	 8533A	
MD8536A	3.6	SOT23-5L	MD85A36QC3	 8536A	
MD8550A	5.0	SOT23-5L	MD85A50QC3	 8550A	
MD8533Q	3.3	SOT23-5L	MD85Q33QC3	 8533Q	
MD8550Q	5.0	SOT23-5L	MD85Q50QC3	 8550Q	
MD8525	2.5	SOT23-3L	MD85E25QA3	 8525	Tape and Reel, 3000pcs
MD8530	3.0	SOT23-3L	MD85E30QA3	 8530	
MD8533	3.3	SOT23-3L	MD85E33QA3	 8533	
MD8536	3.6	SOT23-3L	MD85E36QA3	 8536	
MD8550	5.0	SOT23-3L	MD85E50QA3	 8550	
MD8555	5.5	SOT23-3L	MD85E55QA3	 8555	
MD8525	2.5	SOT89-3L	MD85E25PA1	 8525	Tape and Reel, 1000pcs
MD8530	3.0	SOT89-3L	MD85E25PA1	 8525	
MD8533	3.3	SOT89-3L	MD85E33PA1	 8533	
MD8536	3.6	SOT89-3L	MD85E36PA1	 8536	
MD8540	4.0	SOT89-3L	MD85E40PA1	 8540	
MD8550	5.0	SOT89-3L	MD85E50PA1	 8550	
MD8553	5.3	SOT89-3L	MD85E53PA1	 8553	
MD8555	5.5	SOT89-3L	MD85E55PA1	 8555	
MD8557	5.7	SOT89-3L	MD85E57PA1	 8557	
MD8580	8.0	SOT89-3L	MD85E80PA1	 8580	
MD85C0	12.0	SOT89-3L	MD85EC0PA1	 85C0	
MD85F0	15.0	SOT89-3L	MD85EF0PA1	 85F0	
MD8518A	1.8	SOT89-3L	MD85A18PA1	 8518A	Tape and Reel, 1000pcs
MD8525A	2.5	SOT89-3L	MD85A25PA1	 8525A	
MD8528A	2.8	SOT89-3L	MD85A28PA1	 8528A	
MD8530A	3.0	SOT89-3L	MD85A30PA1	 8530A	
MD8533A	3.3	SOT89-3L	MD85A33PA1	 8533A	

**MD85XX Series**  
**High Voltage Low Power Consumption LDO**

MD8535A	3.5	SOT89-3L	MD85A35PA1	 8535A	
MD8536A	3.6	SOT89-3L	MD85A36PA1	 8536A	
MD8540A	4.0	SOT89-3L	MD85A40PA1	 8540A	
MD8544A	4.4	SOT89-3L	MD85A44PA1	 8544A	
MD8550A	5.0	SOT89-3L	MD85A50PA1	 8550A	
MD8580A	8.0	SOT89-3L	MD85A80PA1	 8580A	
MD8590A	9.0	SOT89-3L	MD85A90PA1	 8590A	
MD85C0A	12.0	SOT89-3L	MD85AC0PA1	 85C0A	
MD85F0A	15.0	SOT89-3L	MD85AF0PA1	 85F0A	
MD8533D	3.3	SOT89-5L	MD85D33PC1	 8533D	
MD8550D	5.0	SOT89-5L	MD85D50PC1	 8550D	
MD8533	3.3	ESOP8	MD85E33SF4	 8533	Tape and Reel, 4000pcs
MD8550	5.0	ESOP8	MD85E50SF4	 8550	
MD85C0	12.0	ESOP8	MD85EC0SF4	 85C0	
MD85F0	15.0	ESOP8	MD85EF0SF4	 85F0	
MD8533G	3.3	ESOP8	MD85G33SF4	 8533G	
MD8533	3.3	SOT223-3L	MD85E33YA2	 8533	Tape and Reel 2500pcs
MD8550	5.0	SOT223-3L	MD85E50YA2	 8550	

**Notes:**

- 1\* Customer can request to customize the output voltage ranged from 1.2V to 15V if desired voltage is not found in the selections.
- 2\* Customer can request customization of package choice.
- 3\* Please pay attention to the MARKING of the product package type.

■ **Absolute Maximum Ratings (Unless otherwise indicated:  $T_a=25^{\circ}\text{C}$ )**

PARAMETER	SYMBOL	RATINGS		UNITS
Input Voltage	$V_{IN}$	-0.3 ~ 45		V
Output Voltage	$V_{OUT}$	$V_{SS}-0.3 \sim V_{IN}+0.3V$		
Power Dissipation	$P_D$	SOT23-5	250	mW
		SOT23-3	250	
		ESOP8	1800	
		SOT89-3	1000	
		SOT89-5	1000	
		SOT223-3	1500	
Thermal Resistance	$R_{\theta JA}$	SOT23-5	180	$^{\circ}\text{C}/\text{W}$
		SOT23-3	200	
		ESOP8	80	
		SOT89-3	100	
		SOT89-5	100	
		SOT223-3	66	
Operating Ambient Temperature	$T_{opr}$	-40 ~ +85		$^{\circ}\text{C}$
Storage Temperature	$T_{stg}$	-40 ~ +125		
ESD Protection	ESD HBM	5000		V
Humidity sensitive level	MSL	3		

**Note:** Stresses above those listed under "Absolute Maximum Ratings" may cause permanent damage to the device.

## ■ Electrical Characteristics

MD85XX Series (Unless otherwise indicated:  $T_a=25^\circ\text{C}$ )

PARAMETER	SYMBOL	CONDITIONS	MIN.	TYP.	MAX.	UNIT	
Output Voltage*1	$V_{OUT(S)}$	$V_{IN}=V_{OUT(S)}+2V$ , $I_{OUT}=1\text{mA}$	$V_{OUT(S)}\times 0.98$	$V_{OUT(S)}$	$V_{OUT(S)}\times 1.02$	V	
Dropout Voltage*2	$V_{DROP}$	$V_{EN}=V_{IN}$ , $V_{OUT(S)}=3.3V$ $I_{OUT}=1\text{mA}$		4	8	mV	
		$V_{EN}=V_{IN}$ , $V_{OUT(S)}=3.3V$ $I_{OUT}=300\text{mA}$		1200	1800		
Line Regulation	$\frac{\Delta V_{OUT}}{\Delta V_{IN} \cdot V_{OUT(S)}}$	$V_{OUT(S)}+2V \leq V_{IN} \leq 40V$ $I_{OUT}=1\text{mA}$		0.01	0.02	%/V	
Load Regulation	$\Delta V_{OUT2}$	$V_{IN}=V_{OUT(S)}+2V$ $1\text{mA} \leq I_{OUT} \leq 300\text{mA}$	$V_{OUT(S)} \leq 5.3V$	25	50	mV	
			$V_{OUT(S)} > 5.3V$	50	80		
Temperature Stability	$\frac{\Delta V_{OUT}}{\Delta T_a \cdot V_{OUT(S)}}$	$V_{IN}=V_{OUT(S)}+2V$ , $I_{OUT}=10\text{mA}$ $-40^\circ\text{C} \leq T_a \leq 125^\circ\text{C}$		$\pm 50$		ppm/ $^\circ\text{C}$	
GND Current ( $V_{EN}=V_{IN}$ )	$I_{GND}$	no load	$V_{OUT(S)} < 3.0V$	0.8	1.2	2	uA
			$3.0 \leq V_{OUT(S)} \leq 5.3V$	1	1.5	2.5	
			$V_{OUT(S)} > 5.3V$	1.5	2.3	3.5	
		$I_{OUT}=100\text{mA}$		420			
Shutdown Current ( $EN=0$ )	$I_{SHUT}$	$V_{IN}=40.0V$ , $V_{EN}=0$		0.1	1		
Input Voltage	$V_{IN}$	---	2.2		40	V	
Maximum Output Current	$I_{OUTMAX}$		300	350		mA	
Current Limit*3	$I_{LIM}$	$V_{IN}=V_{OUT(S)}+2V$ , $V_{OUT}=0.95 \times V_{OUT(S)}$	350	550			
Short Circuit Current*4	$I_{SHORT}$	$V_{IN}=V_{EN}=V_{OUT(S)}+2.0V$ $V_{OUT}=0V$		65			
Power Supply Rejection Ratio	PSRR	$f=100\text{Hz}$ , $I_{OUT}=10\text{mA}$		79		dB	
		$f=1\text{kHz}$ , $I_{OUT}=10\text{mA}$		62			
		$f=10\text{kHz}$ , $I_{OUT}=10\text{mA}$		48			
		$f=100\text{kHz}$ , $I_{OUT}=10\text{mA}$		40			
EN 'H' Level Voltage	$V_{ENH}$		1.5		40.0	V	
EN 'L' Level Voltage	$V_{ENL}$		0		0.6		
EN 'H' Level Current	$I_{ENH}$	$V_{IN}=40V$ , $V_{EN}=V_{IN}$	-0.1		0.1	uA	
EN 'L' Level Voltage	$I_{ENL}$	$V_{IN}=40V$ , $V_{EN}=0$	-0.1		0.1		
Over Temperature Protection	OTP	$I_{OUT}=1\text{mA}$		170		$^\circ\text{C}$	

### Notes:

- $V_{OUT(S)}$ : Output voltage when  $V_{IN}=V_{OUT}+2V$ ,  $I_{OUT}=1\text{mA}$ .
- $V_{DROP}=V_{IN1} - (V_{OUT(S)} \times 0.98)$  where  $V_{IN1}$  is the input voltage when  $V_{OUT} = V_{OUT(S)} \times 0.98$ .
- $I_{LIM}$ : Output current when  $V_{IN}=V_{OUT(S)}+2V$  and  $V_{OUT} = 0.95 \times V_{OUT(S)}$ .
- $V_{OUT}$  pin should be shorted to GND pin, and the impedance between them is less than 0.1 ohm.

■ Typical Performance Characteristics

Test Conditions:  $V_{IN}=V_{OUT}+2.0V$ ,  $C_{IN}=2.2\mu F$ ,  $C_{OUT}=2.2\mu F$ ,  $T_a=25^\circ C$ , unless otherwise indicated.

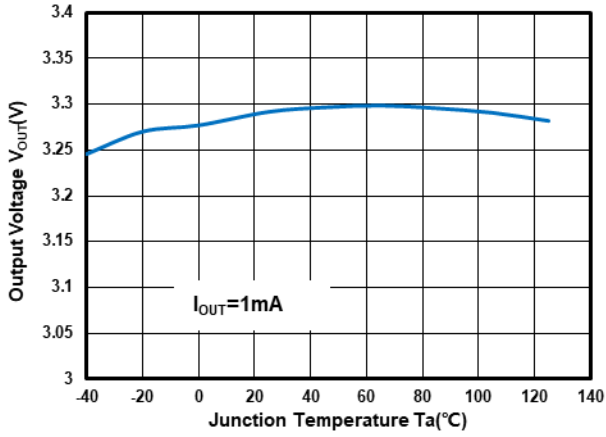

Output Voltage vs Temperature at  $V_{OUT}=3.3V$

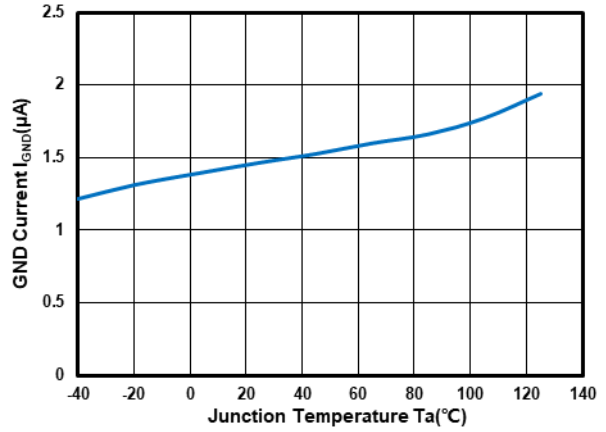

GND Current vs Temperature at  $V_{OUT}=3.3V$

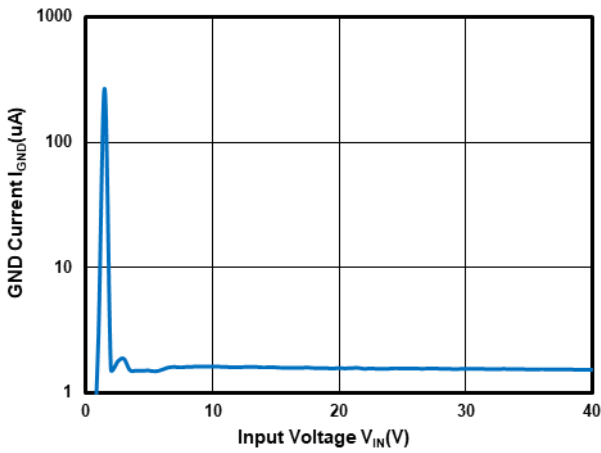

GND Current vs Input Voltage at  $V_{OUT}=3.3V$

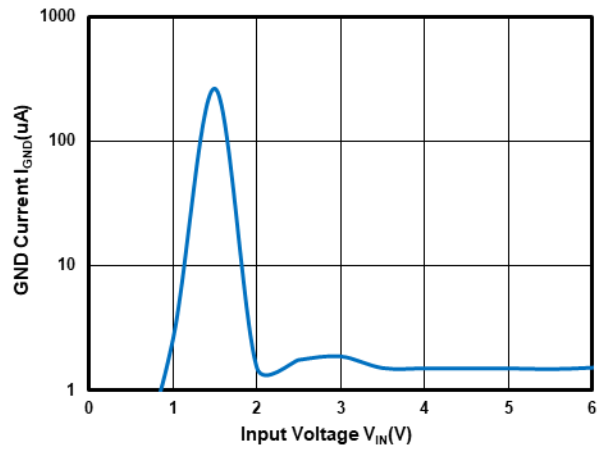

GND Current vs Input Voltage at  $V_{OUT}=3.3V$

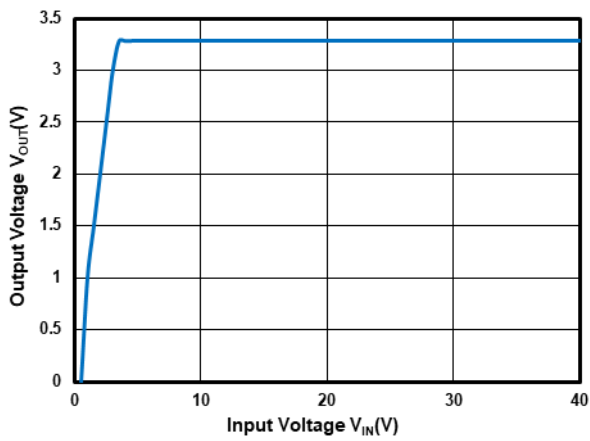

Output Voltage vs Input Voltage at  $V_{OUT}=3.3V$

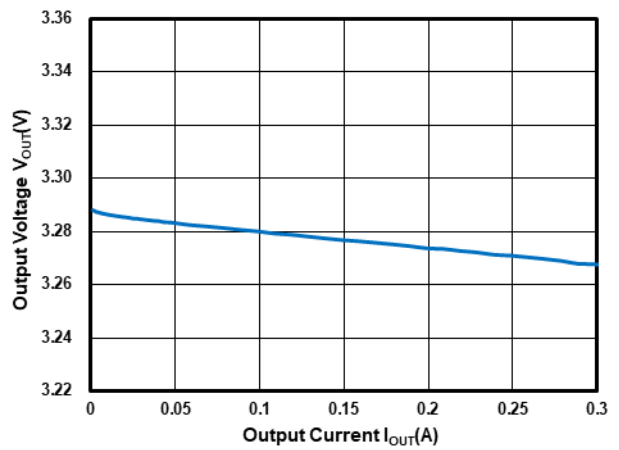

Output Voltage vs Output Current at  $V_{OUT}=3.3V$

■ Typical Performance Characteristics (Continued)

Test Conditions:  $V_{IN}=V_{OUT}+2.0V$ ,  $C_{IN}=2.2\mu F$ ,  $C_{OUT}=2.2\mu F$ , unless otherwise indicated.

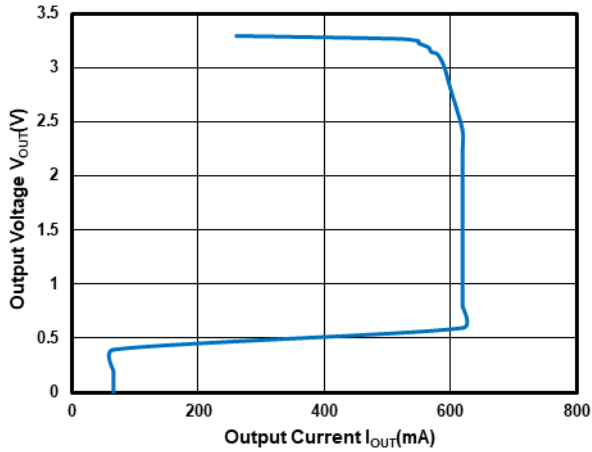

Output Current Fold-back at  $V_{OUT}=3.3V$

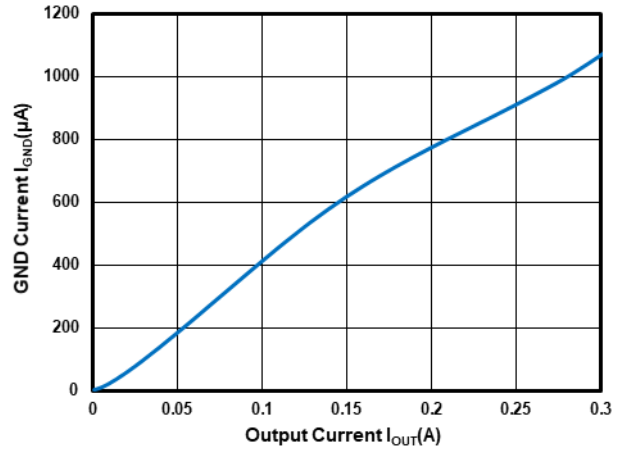

GND Current vs Output Current at  $V_{OUT}=3.3V$

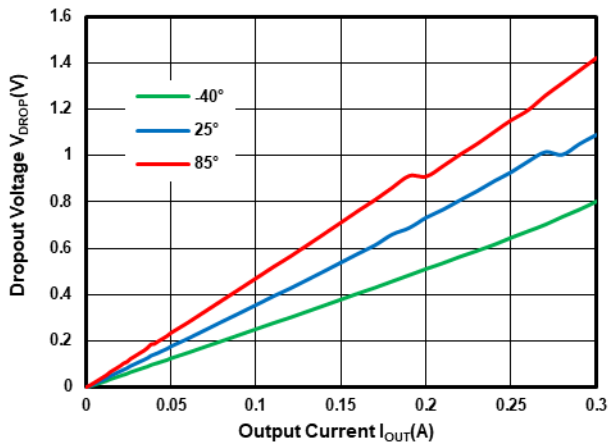

Dropout Voltage vs Temperature at  $V_{OUT}=3.3V$

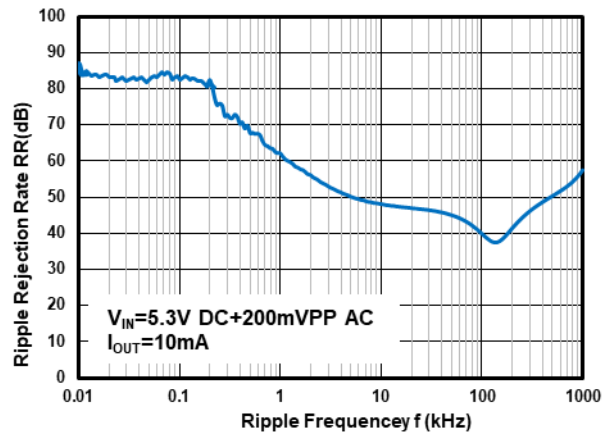

Power Supply Rejection Ratio at  $V_{OUT}=3.3V$

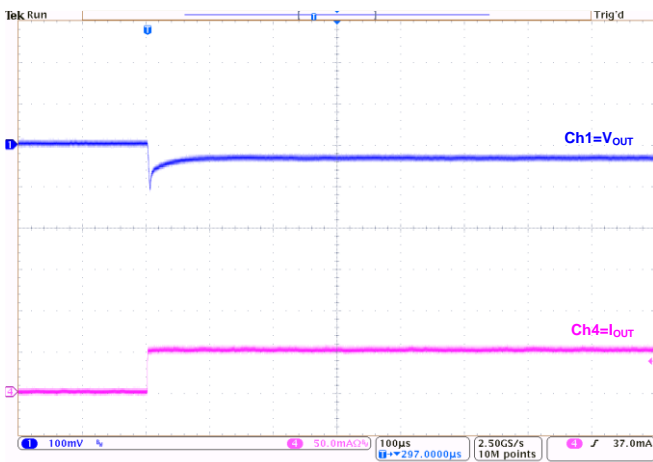

Load Transient at  $V_{OUT}=3.3V$ :  
( $I_{OUT}=0mA\sim 50mA$ )

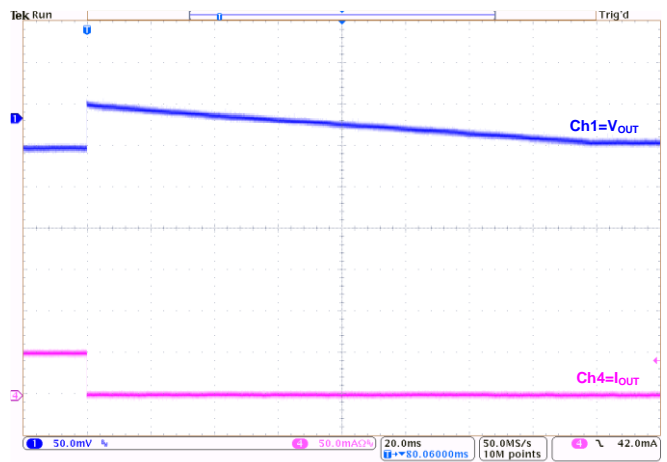

Load Transient at  $V_{OUT}=3.3V$ :  
( $I_{OUT}=50mA\sim 0mA$ )



■ Typical Performance Characteristics (Continued)

Test Conditions:  $V_{IN}=V_{OUT}+2.0V$ ,  $C_{IN}=2.2\mu F$ ,  $C_{OUT}=2.2\mu F$ ,  $T_a=25^\circ C$ , unless otherwise indicated.

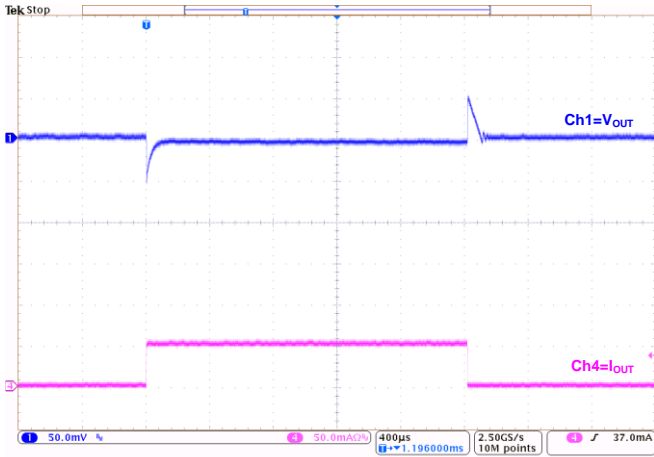

Load Transient at  $V_{OUT}=3.3V$ :  
( $I_{OUT}=1mA\sim 50mA\sim 1mA$ )

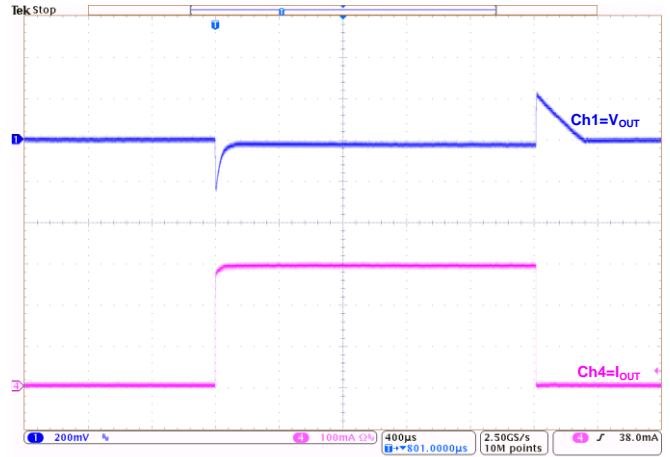

Load Transient at  $V_{OUT}=3.3V$ :  
( $I_{OUT}=1mA\sim 300mA\sim 1mA$ )

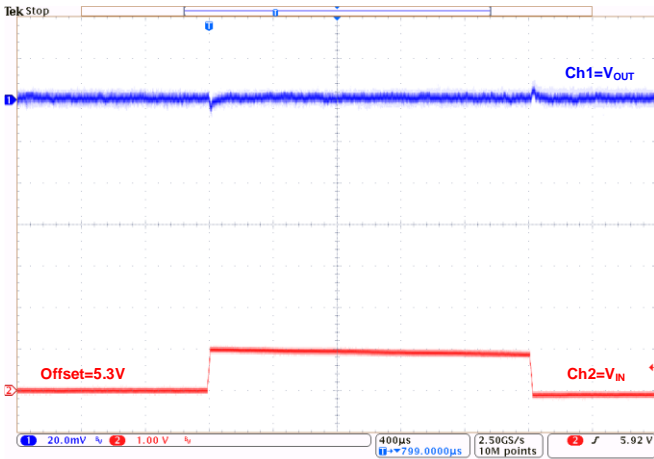

Line Transient at  $V_{OUT}=3.3V$ :  
( $I_{OUT}=1mA$ )

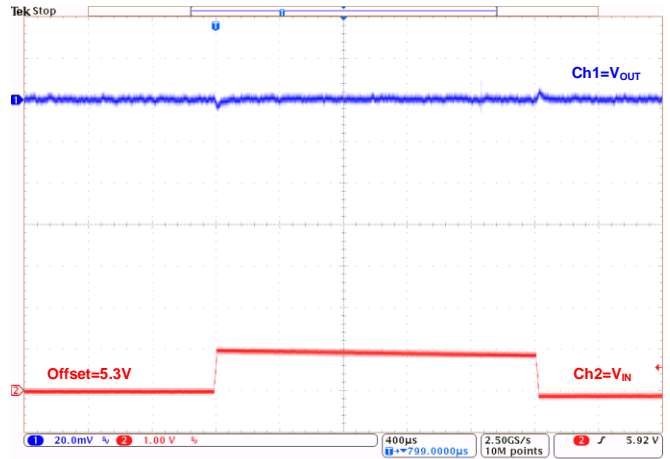

Line Transient at  $V_{OUT}=3.3V$ :  
( $I_{OUT}=10mA$ )

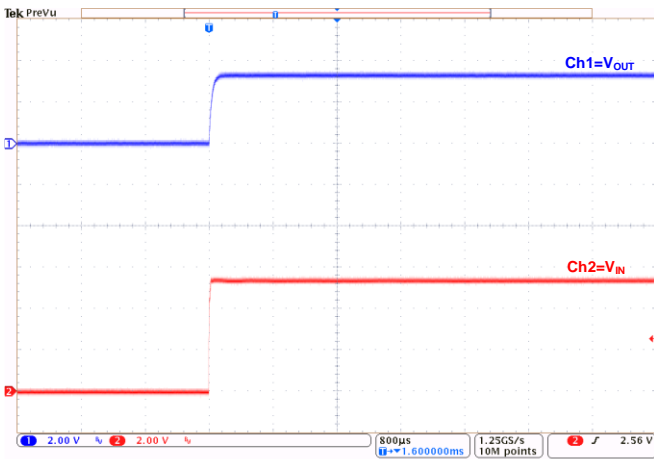

Power-Up at  $V_{OUT}=3.3V$ :  
( $I_{OUT}=1mA$ )

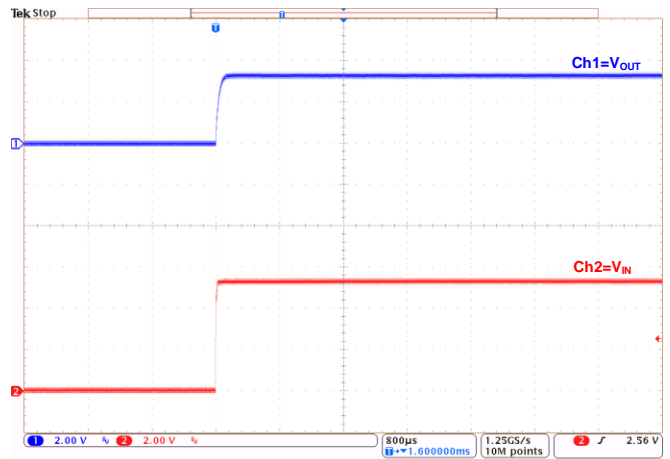

Power-Up at  $V_{OUT}=3.3V$ :  
( $I_{OUT}=300mA$ )

### ■ Typical Performance Characteristics (Continued)

Test Conditions:  $V_{IN}=V_{OUT}+2.0V$ ,  $C_{IN}=2.2\mu F$ ,  $C_{OUT}=2.2\mu F$ ,  $T_a=25^\circ C$ , unless otherwise indicated.

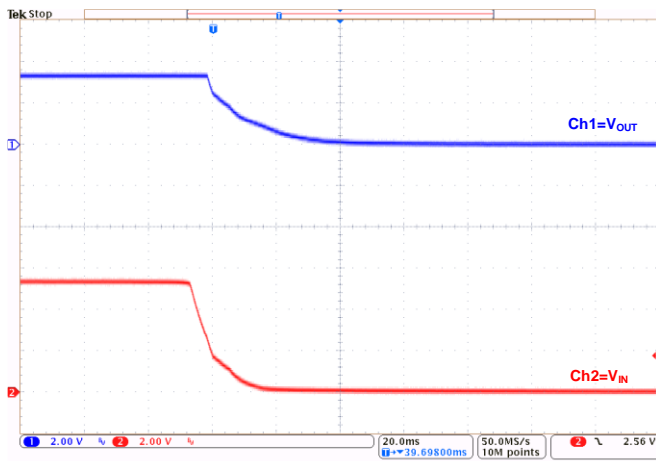

Power-Down at  $V_{OUT}=3.3V$ :  
( $I_{OUT}=1mA$ )

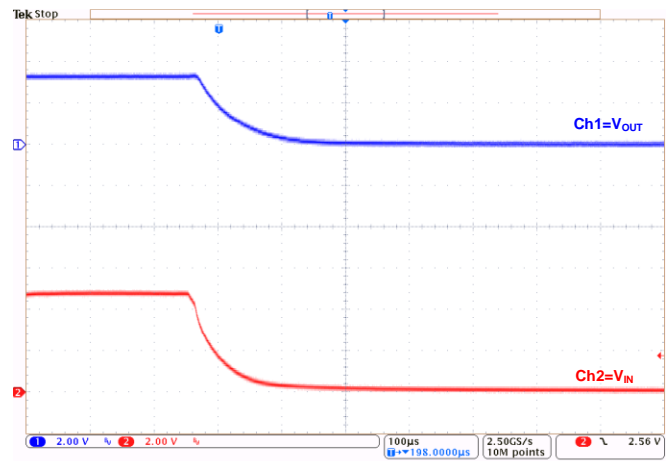

Power-Down at  $V_{OUT}=3.3V$ :  
( $I_{OUT}=300mA$ )

## ■ Operational Explanation

### 1. Output voltage control

The voltage divided by resistors R1 and R2 is compared with the internal reference voltage by the error amplifier. The amplifier output then drives the P-channel MOSFET connected to the  $V_{OUT}$  pin. The output voltage at the  $V_{OUT}$  pin is regulated by this negative feedback system. The current limit circuit and short protect circuit operate in relation to output current level. Further, the IC's internal circuitry can be in operation or shutdown modes controlled by the CE pin's signal.

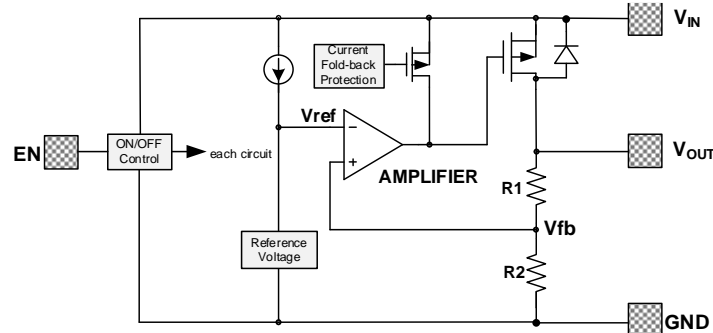

### 2. Pass transistor

The pass transistor with low turn-on resistance used in MD85XX is a P-channel MOSFET. If the potential on  $V_{OUT}$  pin is higher than  $V_{IN}$ , it is possible that IC will be destroyed due to reverse current which is caused by parasitic diodes between  $V_{IN}$  and  $V_{OUT}$ . Therefore, the  $V_{OUT}$  pin potential exceeds  $V_{IN}+0.3V$  is not allowed.

### 3. Current foldback and over temperature protection

The MD85XX series includes a combination of a fixed current limiter circuit and a foldback circuit, which aid the operations of the current limiter and circuit protection. When the load current reaches the current limit level, the fixed current limiter circuit operates and output voltage drops. As a result of this drop in output voltage, the foldback circuit operates, output voltage drops further and output current decreases. This design can prevent the chip be damaged due to over temperature, moreover, the heat dissipation is limited by the package type.

Special attention should be paid to that the product of the dropout voltage on the chip and the output current must be smaller than the heat dissipation. If power consumption on the chip is more than the heat dissipation, OTP will protect the chip from damaging due to over temperature.

## ■ Notes:

1. The input and output capacitors should be placed as close as possible to the IC.
2. If the impedance of the power supply is high, which is caused by forgetting installing input capacitor or installing too small value capacitor, the oscillation may occur.
3. Pay attention to the operation conditions of input and output voltage and load current, such that the power consumption in the IC should not exceed the allowable power consumption of the package even though the chip has short circuit protection.
4. IC has a built-in anti-static protection (ESD) circuit, but please do not add excessive stress to the IC.

■ Packaging Information

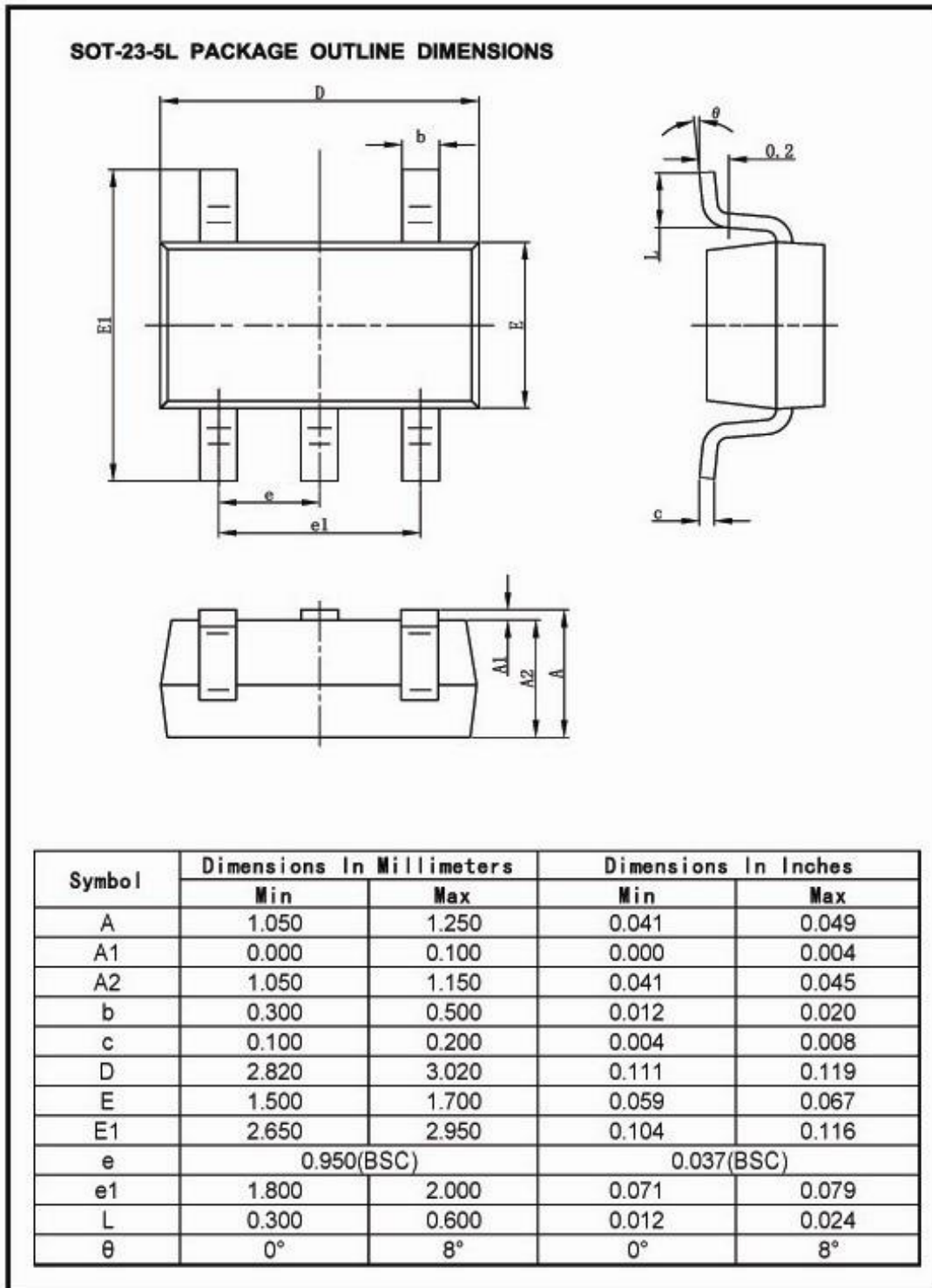

■ Packaging Information (Continued)

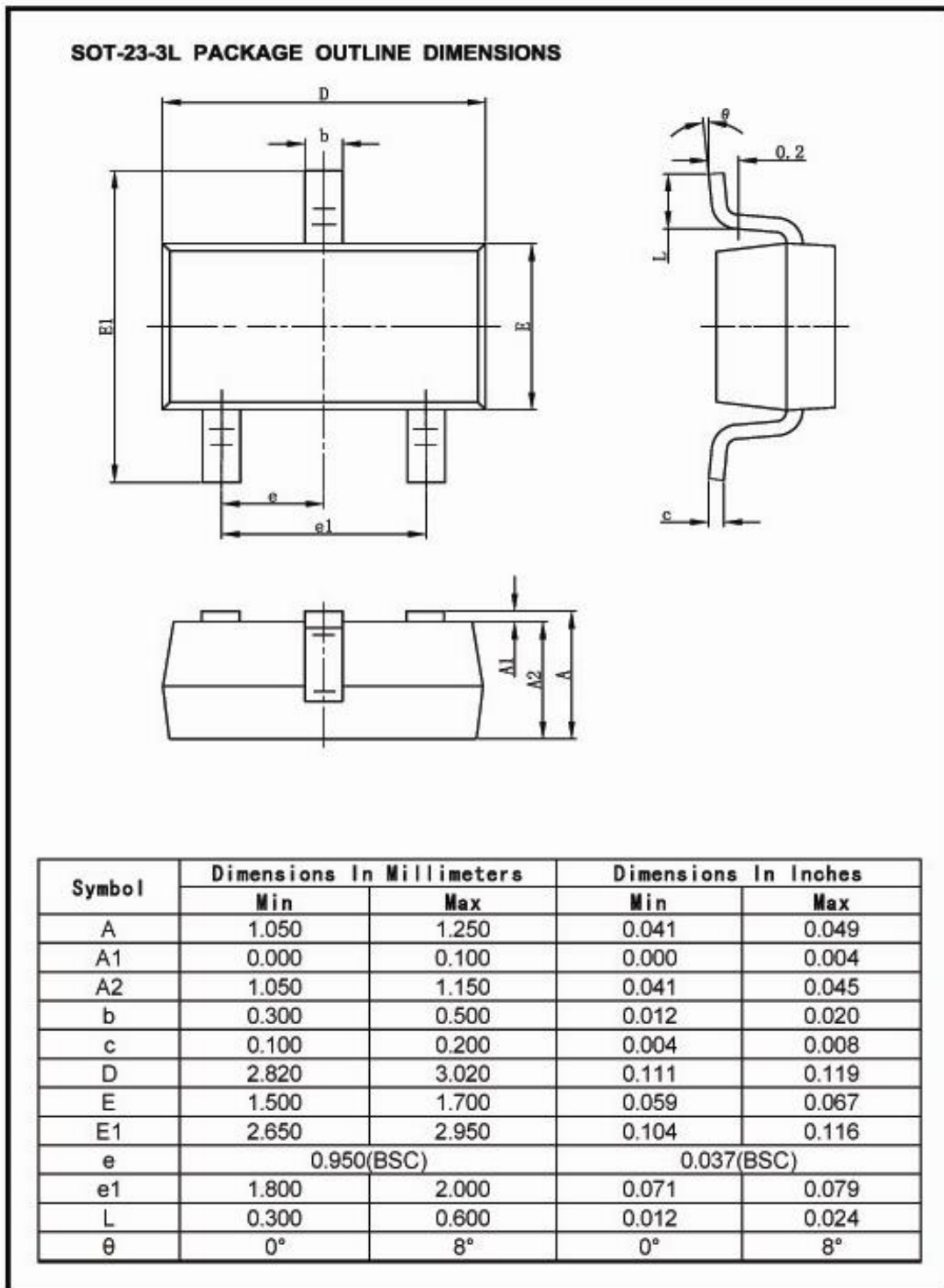

■ Packaging Information (Continued)

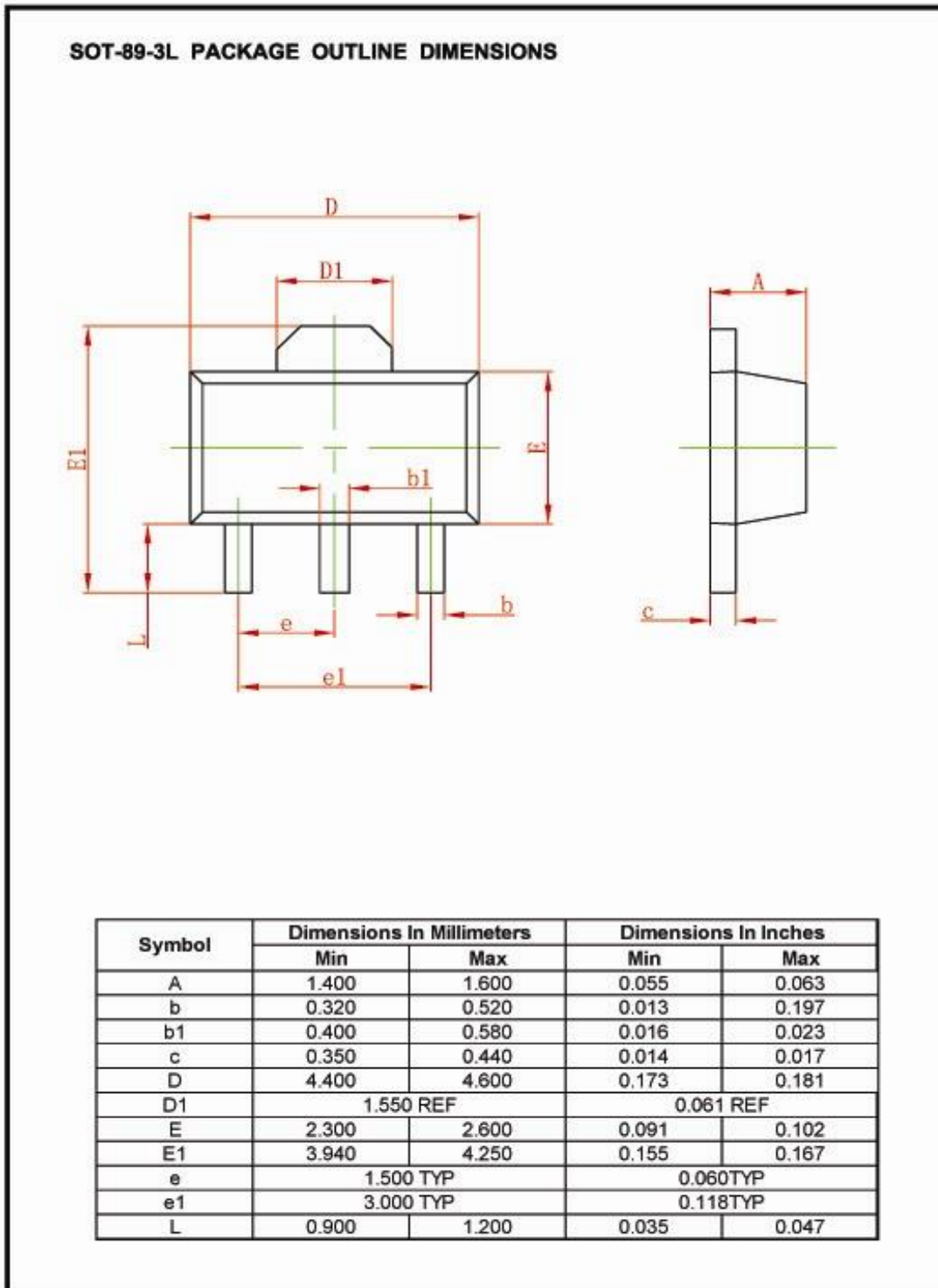

■ Packaging Information (Continued)

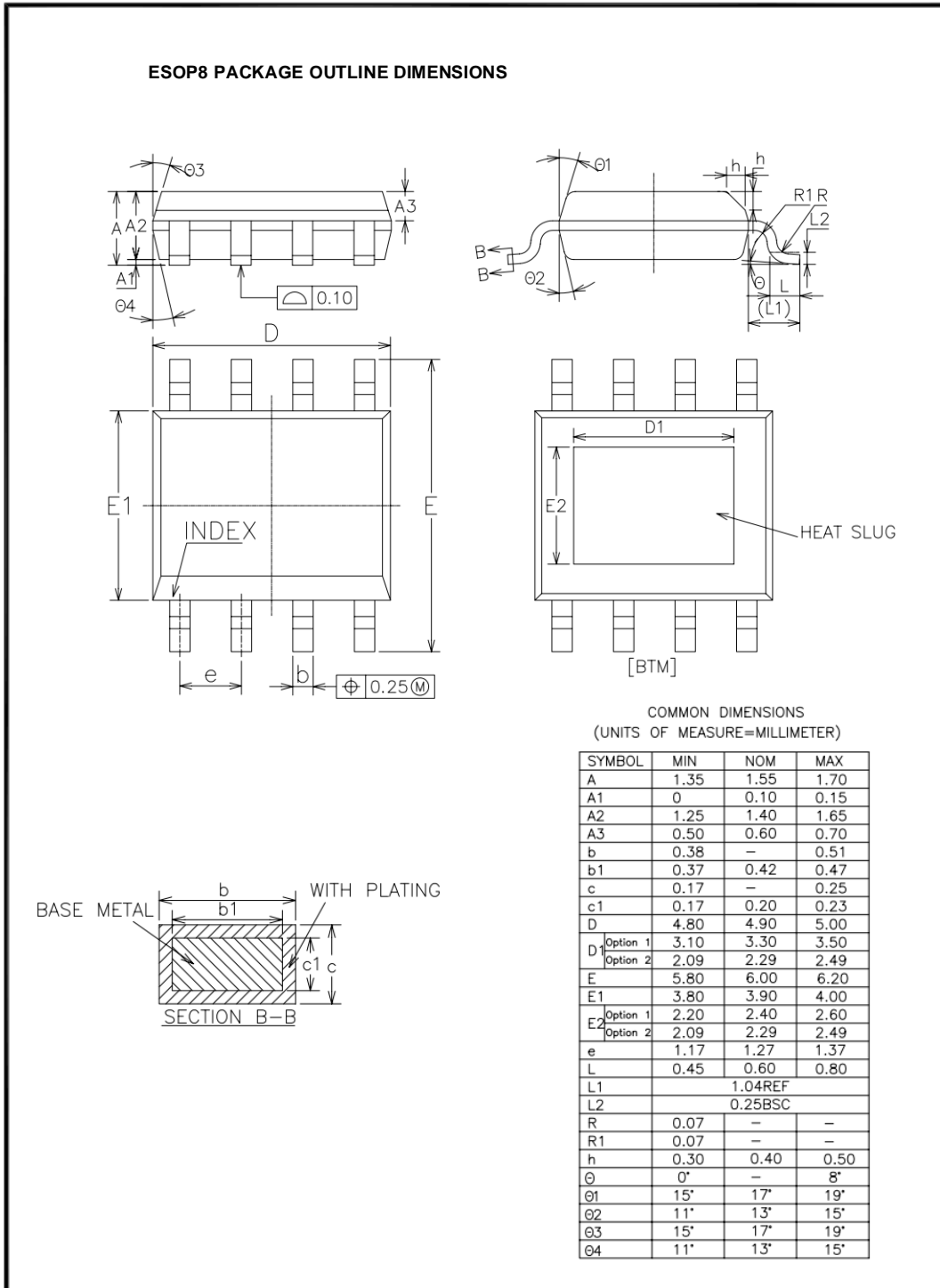

■ Packaging Information (Continued)

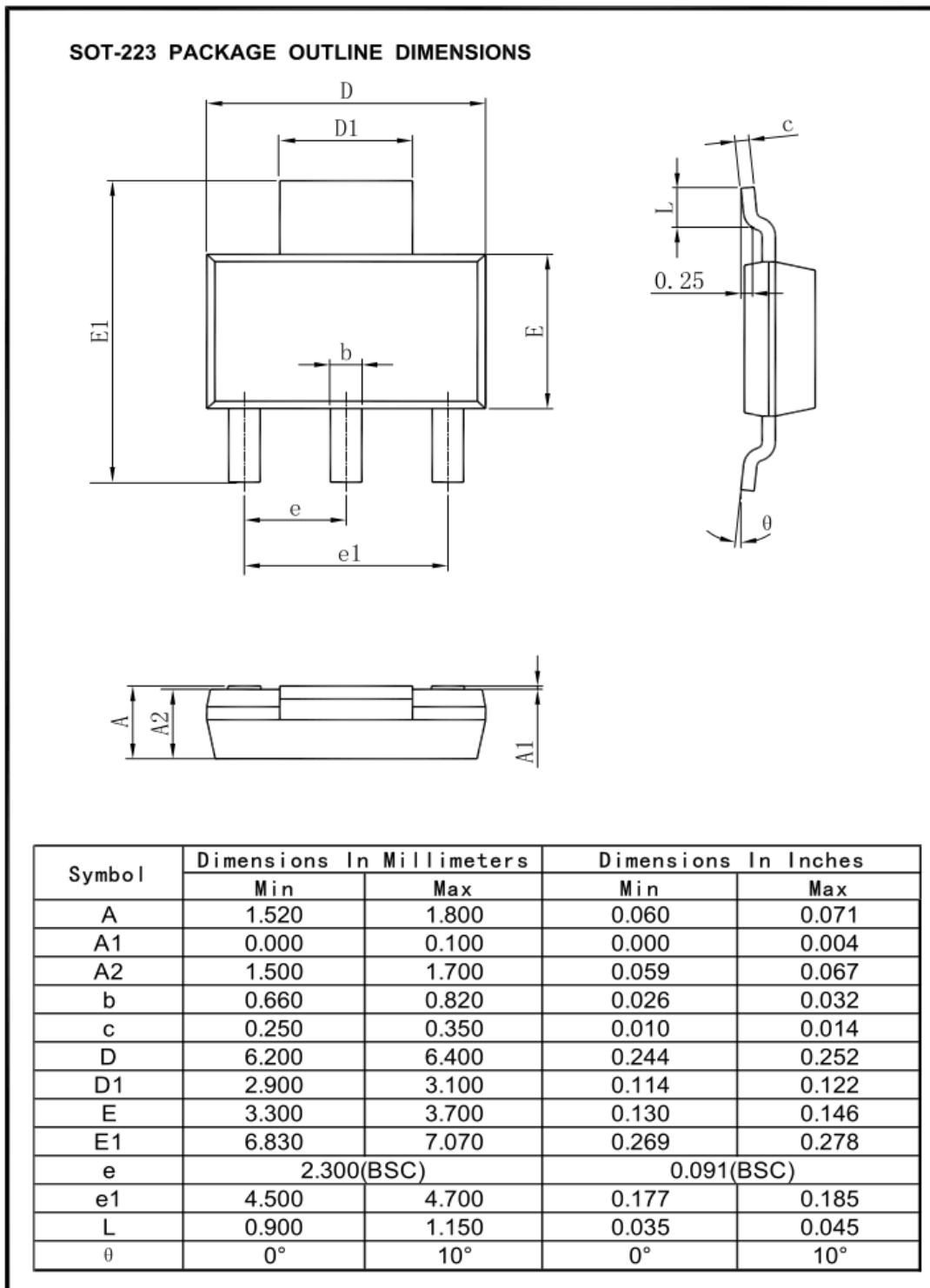



■ Packaging Information (Continued)

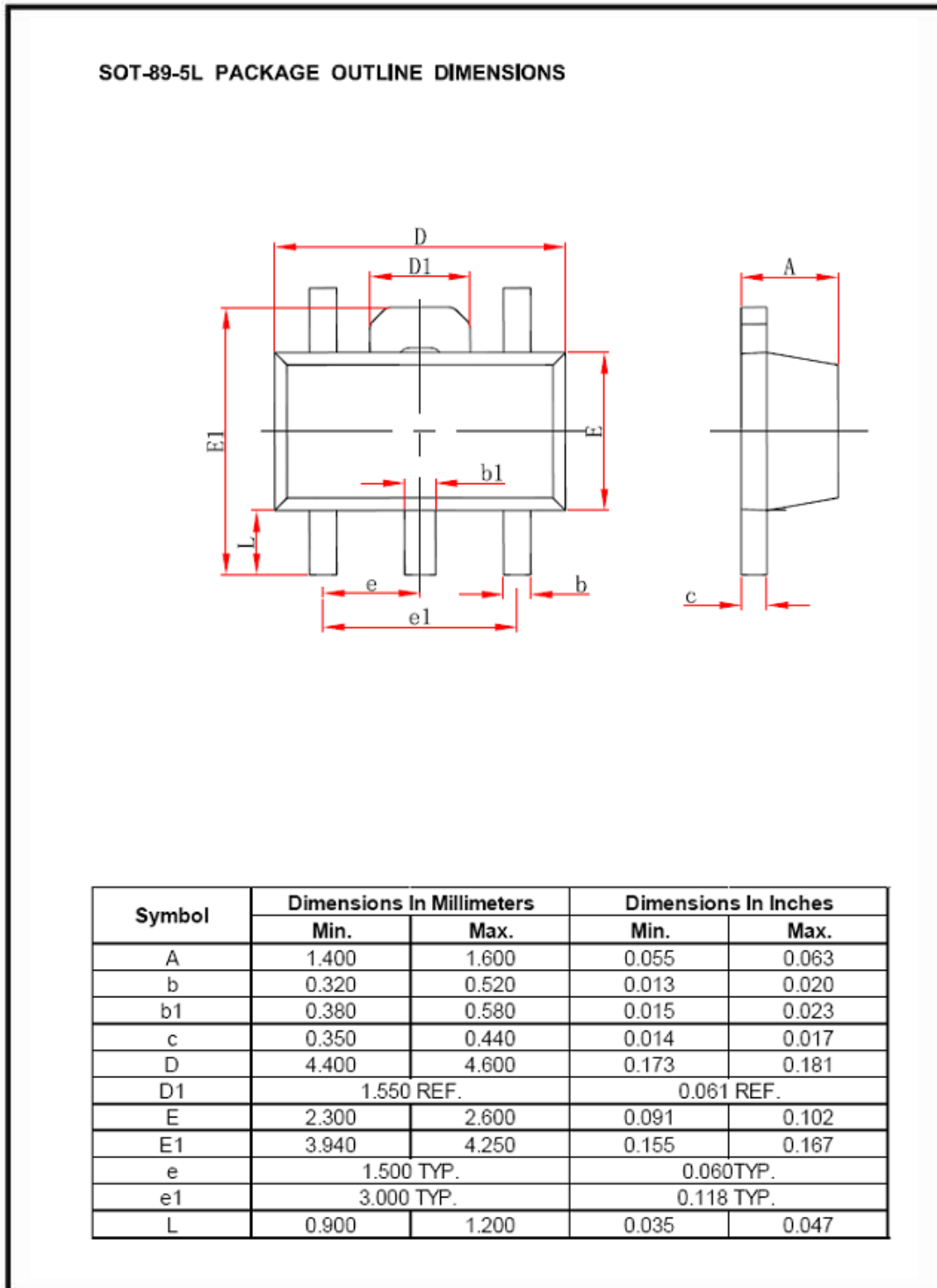

For the newest datasheet, please see the website:

[www.md-ic.com.cn](http://www.md-ic.com.cn)

Version V1.5 20220401