

## MCM 2012 B Series

# Specification

<b>Product Name</b>	<b>Chip Common Mode Filter</b>
<b>Series</b>	<b>MCM B Series</b>
<b>Size</b>	<b>EIAJ 2012</b>



## MCM2012B SERIES (Chip Common Mode Filter) Engineering Specification

### Features and Application

- Powerful components with composite co-fired material to solve EMI problem for high speed differential signal transmission line as USB, and LVDS, without distortion to high speed signal transmission.

### 1.PRODUCT DETAIL

Part No.	Imp. Com. ( $\Omega$ ) $\pm$ 25% @100MHz	DCR Max. ( $\Omega$ )	Rated Current Max.(mA)	Rated Voltage (V)	Withstand Voltage (V)	Insulation Resistance Min.(M $\Omega$ )
MCM2012B670GBE	67	0.40	400	10	25	200
MCM2012B900GBE	90	0.40	400	10	25	200
MCM2012B121GBE	120	0.40	400	10	25	200
MCM2012B161GBE	160	0.50	400	10	25	200
MCM2012B181GBE	180	0.50	400	10	25	200
MCM2012B221FBE	220	0.50	300	10	25	200
Test Instruments	•Agilent E4991A RF IMPEDANCE / MATERIAL ANALYZER •HP4338 MILLIOHMMETER •Agilent E5071C ENA SERIES NETWORK ANALYZER •Keithley 2410 1100V SOURCE METER					

### 2.PART NUMBER CODE

MCM 2012 B 90 0 G B E  
 1        2        3        4        5        6        7        8

- 1 Series Name
- 2 Size Code: the first two digitals : length(mm), the last two digitals : width(mm)
- 3 Material Code
- 4 Impedance( $\Omega$ )  $\pm$  25% } (ex : 900=90 $\Omega$  ; 121=120 $\Omega$ )
- 5 Fixed Decimal Point }
- 6 Rated Current Code

A=50mA	B=80mA	C=100mA	D=150mA	E=200mA	F=300mA
G=400mA	H=500mA	I=600mA	J=700mA	K=800mA	

- 7 Soldering: Green Parts: A— Soldering Lead-Free B— Lead-Free for whole chip
- 8 Packaging: E - Embossed plastic tape, 7" reel.

### 3.TYPICAL CHARACTERISTIC

#### MCM2012B670

IMPEDANCE vs. FREQUENCY CHARACTERISTICS

INSERTION LOSS vs. FREQUENCY CHARACTERISTICS

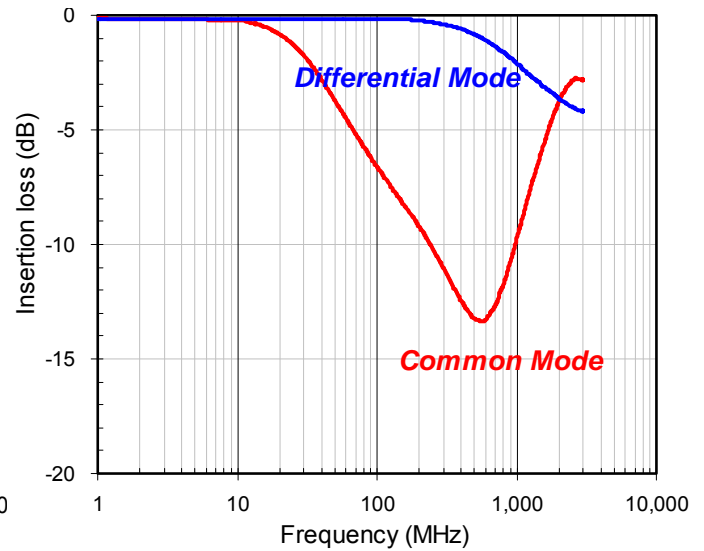
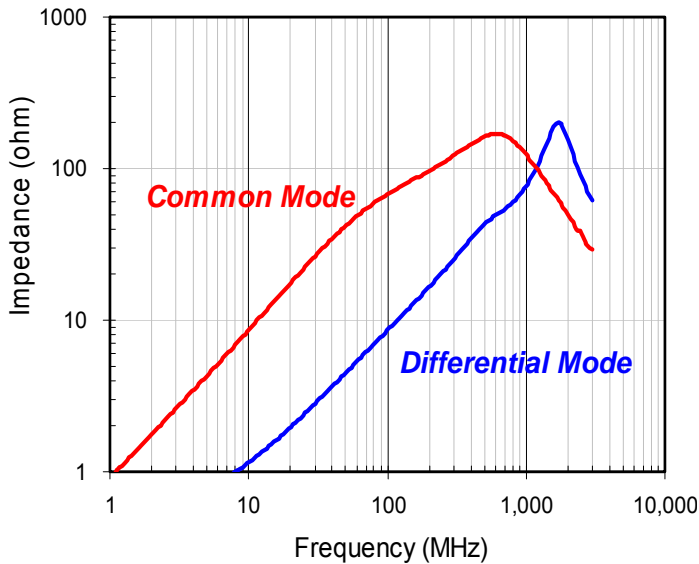

#### MCM2012B900

IMPEDANCE vs. FREQUENCY CHARACTERISTICS

INSERTION LOSS vs. FREQUENCY CHARACTERISTICS

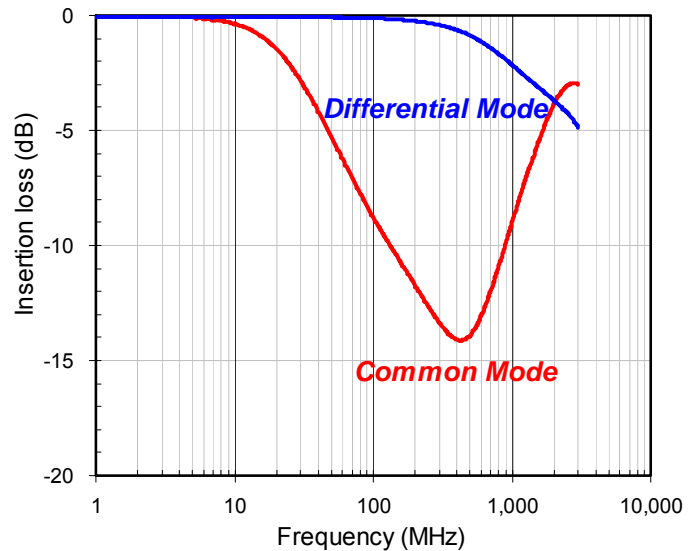
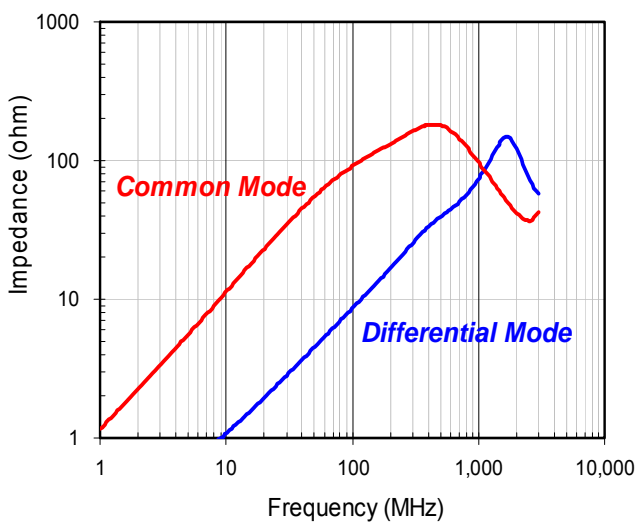

### MCM2012B121

IMPEDANCE vs. FREQUENCY CHARACTERISTICS

INSERTION LOSS vs. FREQUENCY CHARACTERISTICS

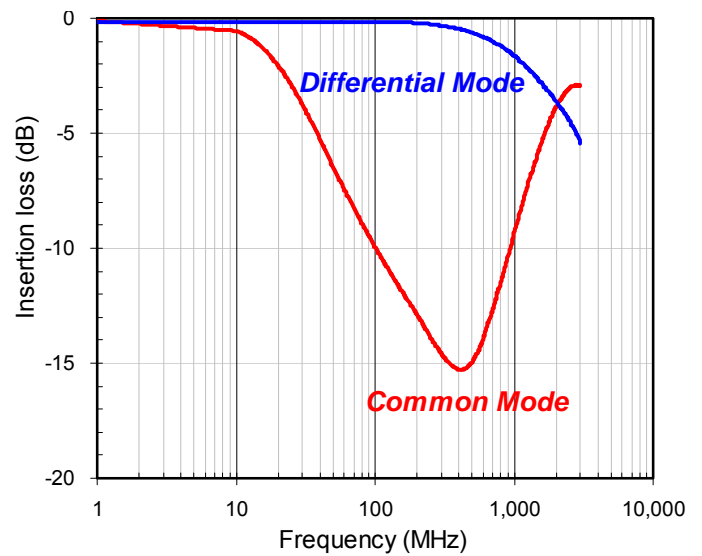
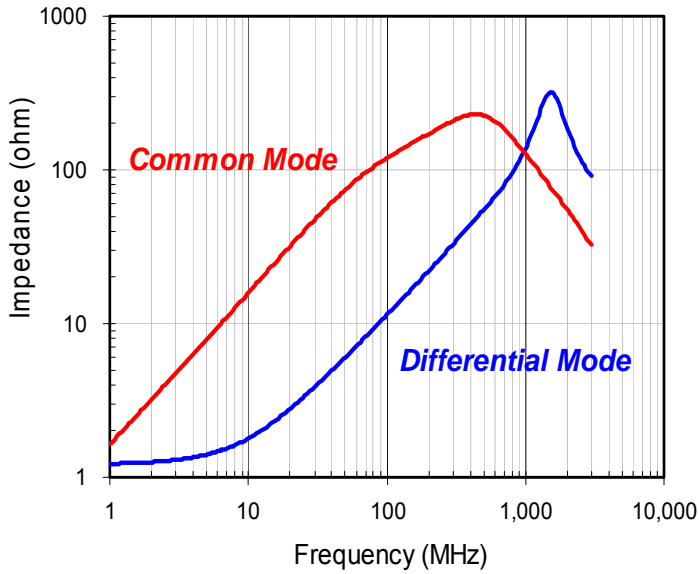

### MCM2012B161

IMPEDANCE vs. FREQUENCY CHARACTERISTICS

INSERTION LOSS vs. FREQUENCY CHARACTERISTICS

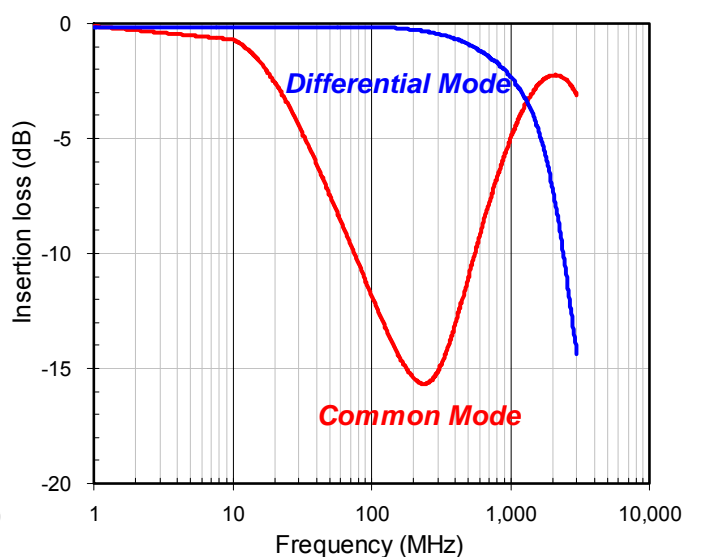
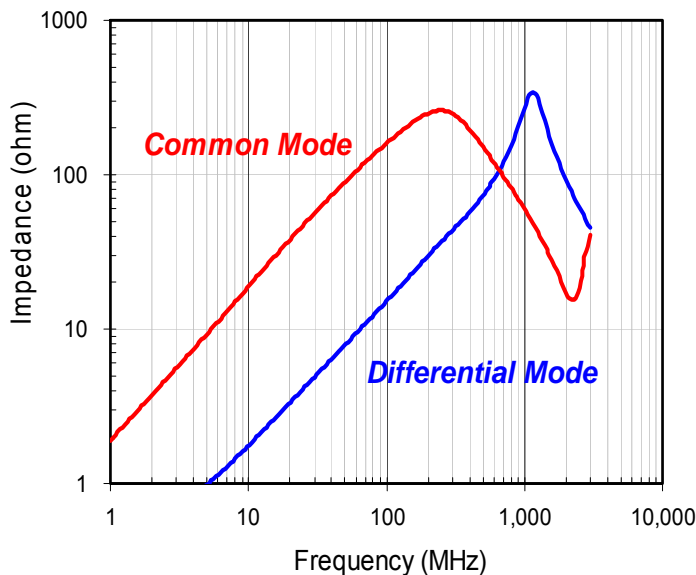

### MCM2012B181

IMPEDANCE vs. FREQUENCY CHARACTERISTICS

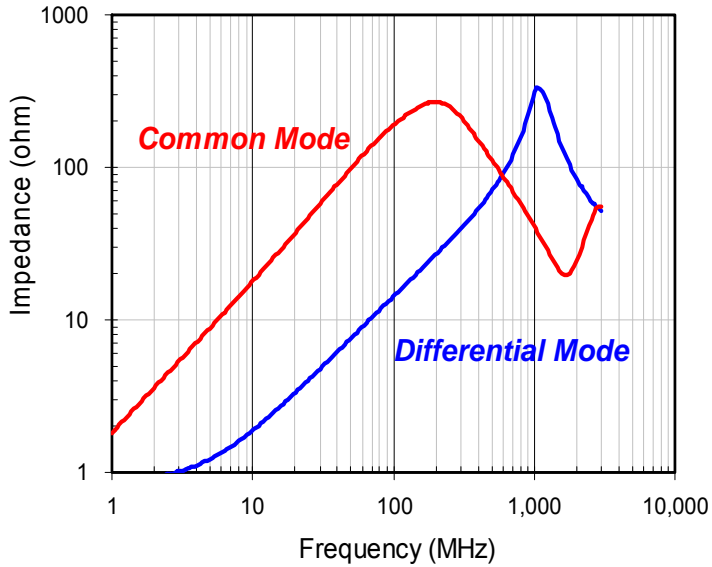

INSERTION LOSS vs. FREQUENCY CHARACTERISTICS

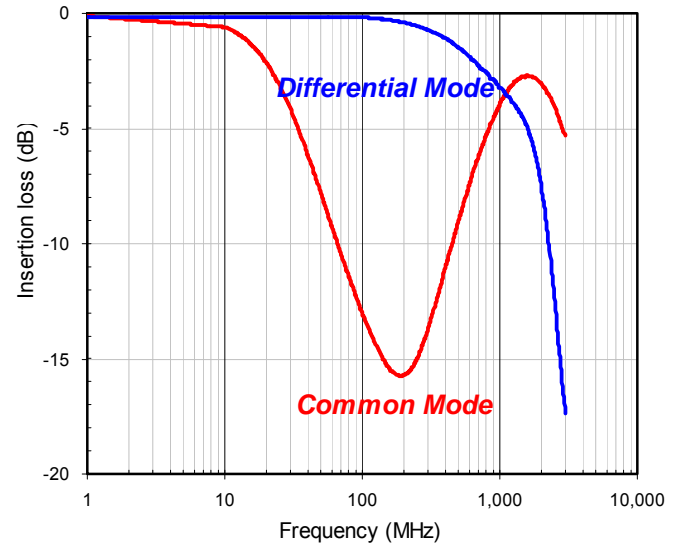

### MCM2012B221

IMPEDANCE vs. FREQUENCY CHARACTERISTICS

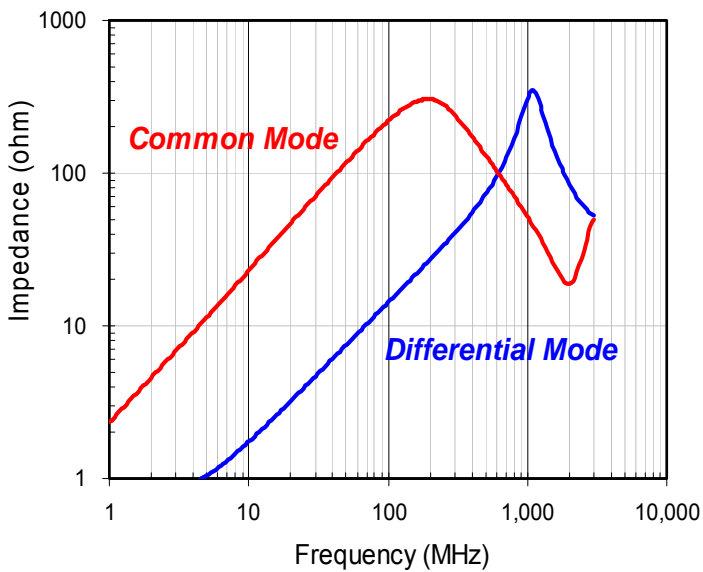

INSERTION LOSS vs. FREQUENCY CHARACTERISTICS

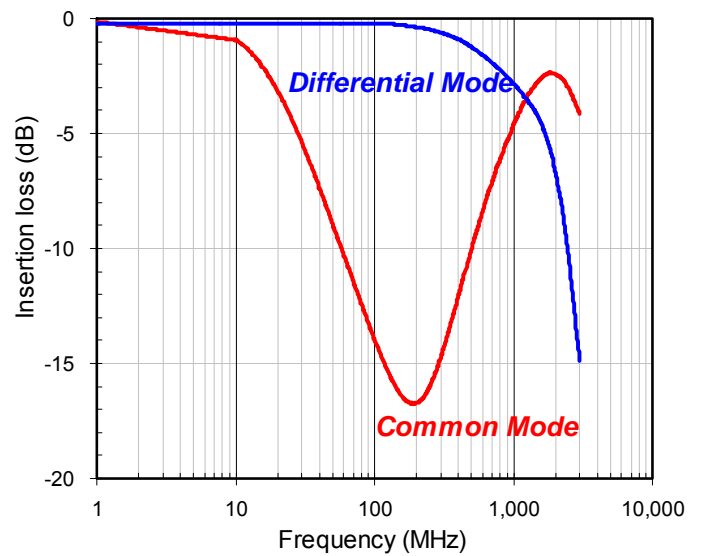

#### 4. SHAPES AND DIMENSIONS

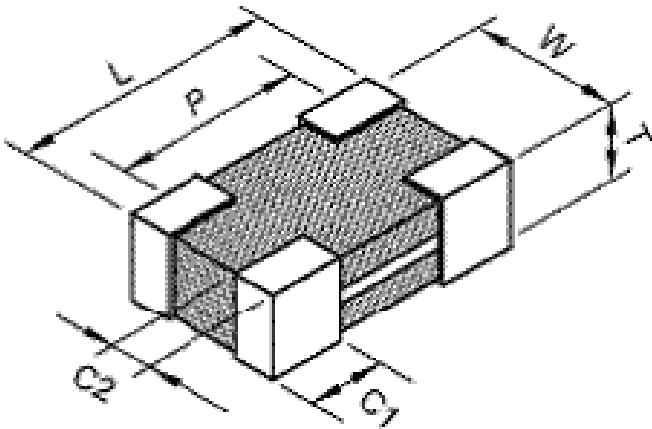

TYPE	2012
L	2.00±0.20
W	1.25±0.20
T	1.00±0.10
P	1.60±0.20
C1	0.40±0.20
C2	0.30±0.20
Unit: mm	

#### 5. MEASURING CIRCUITS

(A): Common mode

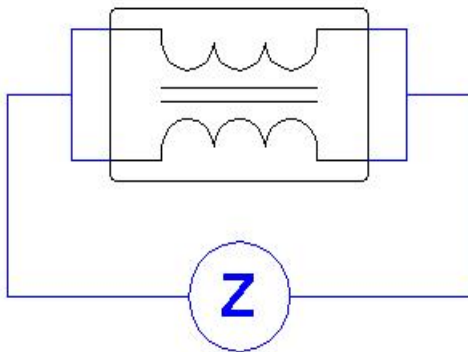

(B): Differential mode

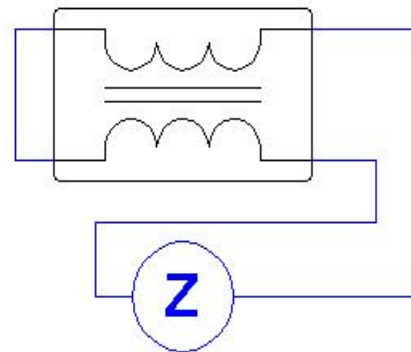

### 6. CIRCUIT CONFIGURATION & LAYOUT PAD

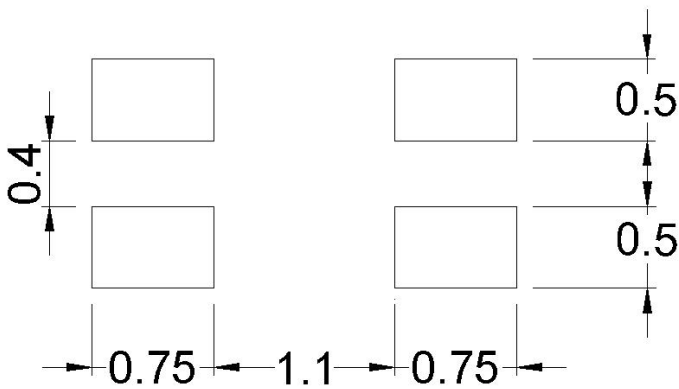
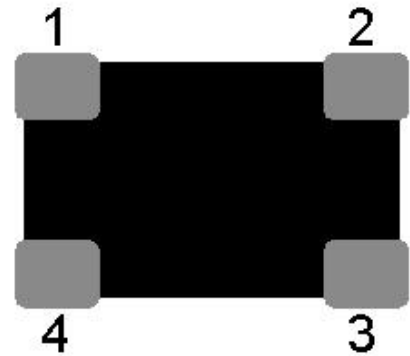
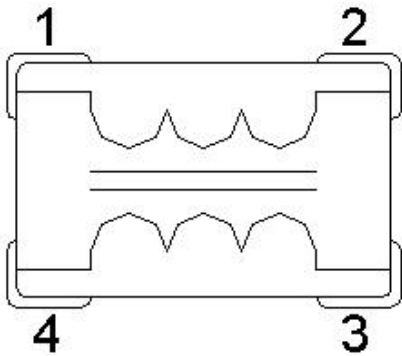

### 7. RECOMMENDED SOLDERING CONDITIONS

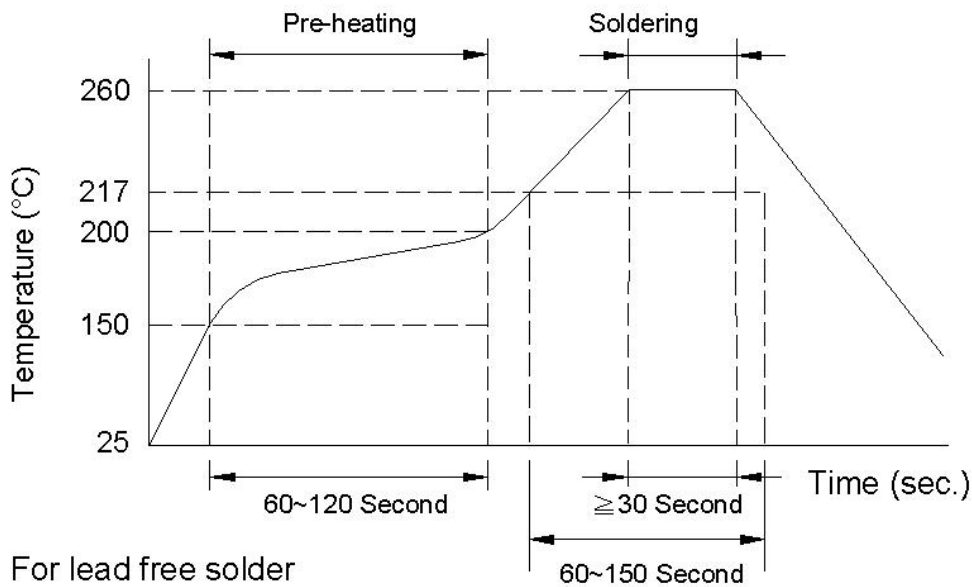

## 8.RELIABILITY AND TEST CONDITION

Test item	Test condition	Criteria
<b>Temperature Cycle</b>	A. Temperature : -40 ~ +85°C B. Cycle : 100 cycles C. Dwell time : 30minutes  Measurement : at ambient temperature 24 hrs after test completion	A. No mechanical damage B. Impedance value should be within $\pm 20\%$ of the initial value
<b>Operational Life</b>	A. Temperature : 85°C $\pm 5^\circ\text{C}$ B. Test time : 1000 hrs C. Apply current : full rated current  Measurement : at ambient temperature 24 hrs after test completion	A. No mechanical damage B. Impedance value should be within $\pm 20\%$ of the initial value
<b>Biased Humidity</b>	A. Temperature : 40 $\pm 2^\circ\text{C}$ B. Humidity : 90 ~ 95 % RH C. Test time : 1000 hrs D. Apply current : full rated current  Measurement : at ambient temperature 24 hrs after test completion	A. No mechanical damage B. Impedance value should be within $\pm 20\%$ of the initial value
<b>Resistance to Solder Heat</b>	A. Solder temperature : 260 $\pm 5^\circ\text{C}$ B. Flux : Rosin C. DIP time : 10 $\pm 1$ sec	A. More than 95 % of terminal electrode should be covered with new solder B. No mechanical damage C. Impedance value should be within $\pm 20\%$ of the initial value
<b>Steam Aging Test</b>	A. Temperature : 93 $\pm 2^\circ\text{C}$ B. Test time : 4 hrs(MCA) Others : 8 hrs C. Solder temperature : 235 $\pm 5^\circ\text{C}$ D. Flux : Rosin E. DIP time : 5 $\pm 1$ sec	More than 95 % of terminal electrode should be covered with new solder



## 9.TAPE AND REEL SPECIFICATIONS

Type : Plastic Carrier

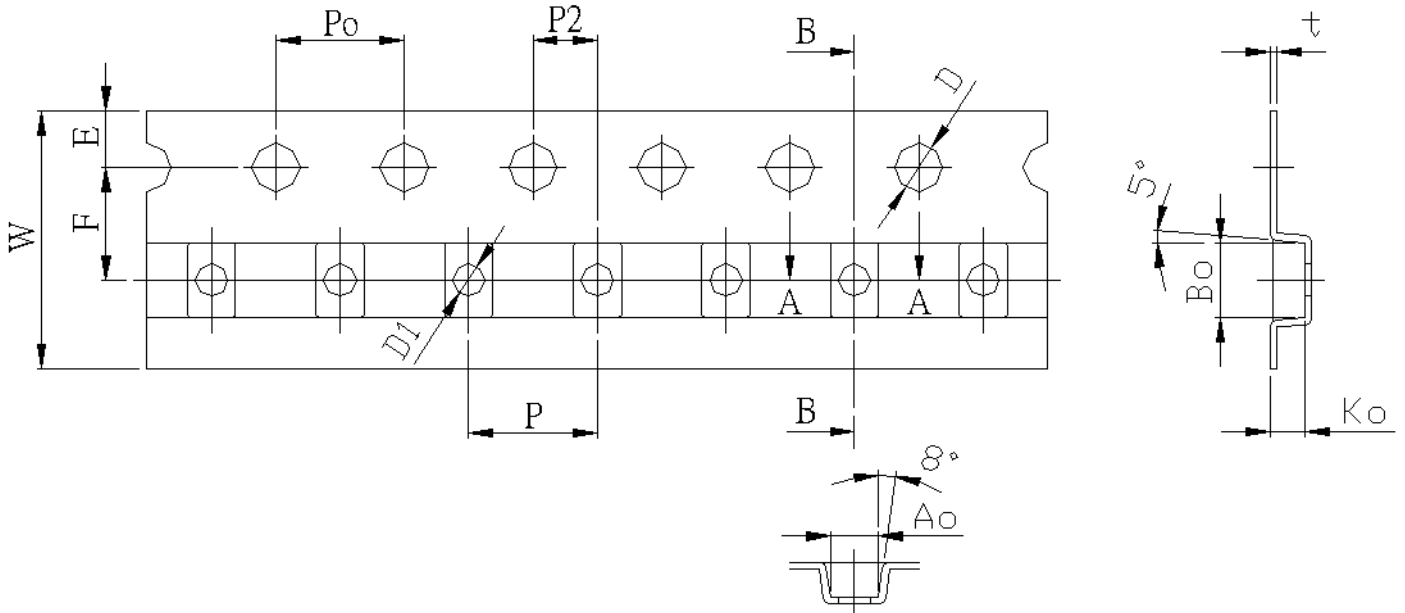

Unit : mm

Symbol	Size	Symbol	Size
W	$8.00 \pm 0.10$	D1	$1.00 \pm 0.10$
P	$4.00 \pm 0.10$	P <sub>0</sub>	$4.00 \pm 0.10$
E	$1.75 \pm 0.10$	A <sub>0</sub>	$1.40 \pm 0.10$
F	$3.50 \pm 0.05$	B <sub>0</sub>	$2.30 \pm 0.10$
P <sub>2</sub>	$2.00 \pm 0.05$	K <sub>0</sub>	$1.13 \pm 0.10$
D	$1.50^{+0.10}_{-0.00}$	t	$0.22 \pm 0.05$

## 10. REEL DIMENSIONS

Unit: mm

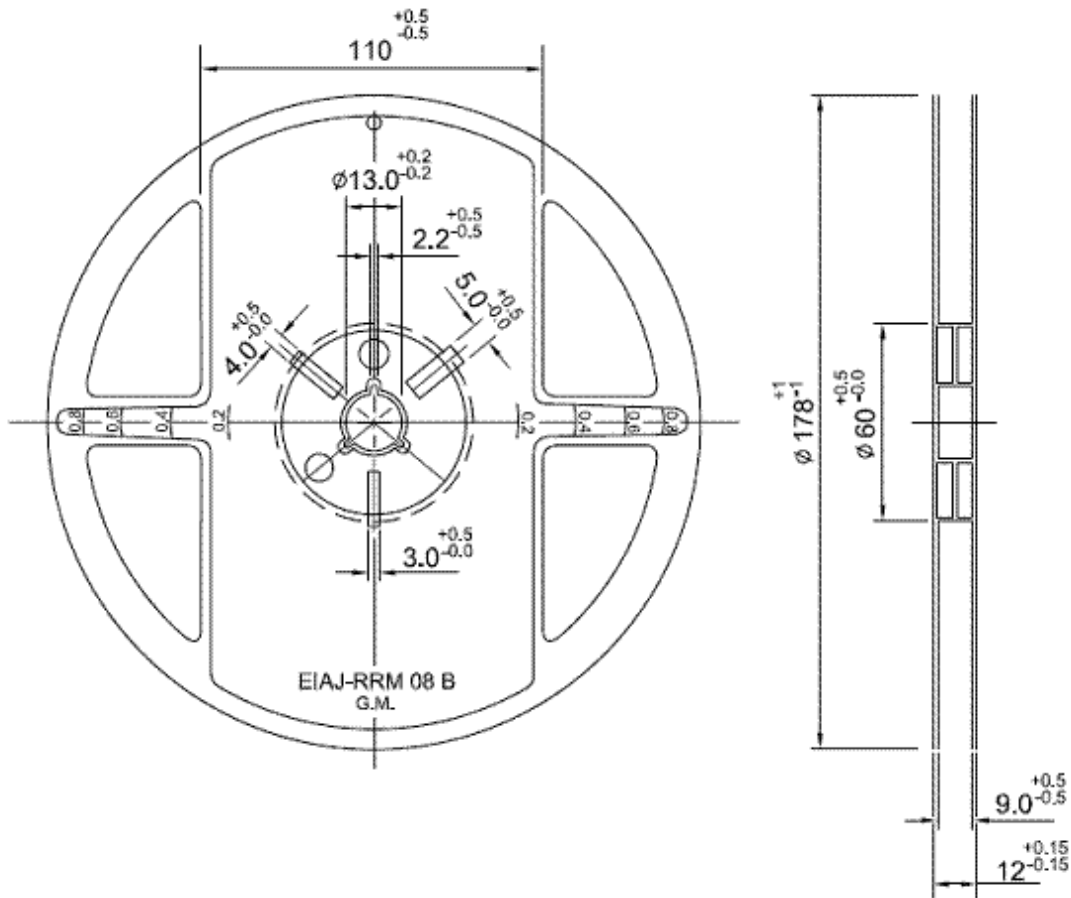

## 11. STANDARD QUANTITY FOR PACKAGING

Packaging style : Taping

Reel packaging quantity : 3000 pcs/reel

Inner box : 5 reel/inner box

## 12. GENERAL TECHNICAL DATA

Operating temperature range : - 40°C ~ +85°C

Storage Condition : Less than 40°C and 70% RH

Storage Time: 6 months Max.

Soldering method: Reflow or Wave Soldering