

SOT-23-6L Plastic-Encapsulate MOSFETS

CJL1206

Dual P-Channel Power MOSFET

$V_{(BR)DSS}$	$R_{DS(on)MAX}$	I_D
-12V	45 mΩ@-4.5V	-6A
	60 mΩ@-2.5V	
	90 mΩ@-1.8V	

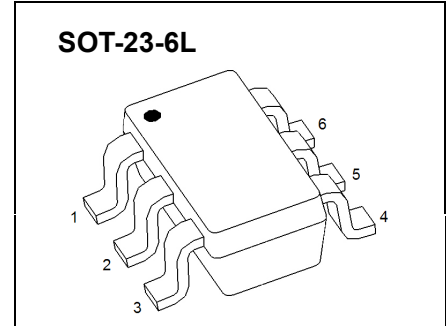

FEATURE

- TrenchFET Power MOSFET

APPLICATION

- Load Switch for Portable Devices
- DC/DC Converter

MARKING

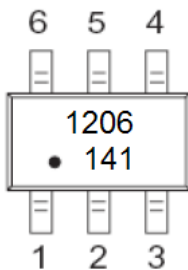

Equivalent Circuit

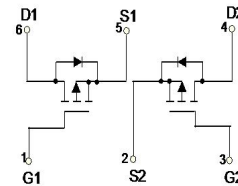

Maximum ratings ($T_a=25^{\circ}C$ unless otherwise noted)

Parameter	Symbol	Value	Unit
Drain-Source Voltage	V_{DS}	-12	V
Gate-Source Voltage	V_{GS}	±8	
Continuous Drain Current	I_D	-6	A
Continuous Source-Drain Diode Current	I_S	-0.8	
Maximum Power Dissipation	P_D	0.35	W
Thermal Resistance from Junction to Ambient($t \leq 10s$)	$R_{\theta JA}$	357	$^{\circ}C/W$
Junction Temperature	T_J	150	$^{\circ}C$
Storage Temperature	T_{STG}	-50 ~+150	

MOSFET ELECTRICAL CHARACTERISTICS

$T_a=25^\circ\text{C}$ unless otherwise specified

Parameter	Symbol	Test Condition	Min	Typ	Max	Units
Static						
Drain-source breakdown voltage	$V_{(BR)DSS}$	$V_{GS} = 0V, I_D = -250\mu A$	-12			V
Gate-source threshold voltage	$V_{GS(th)}$	$V_{DS} = V_{GS}, I_D = -250\mu A$	-0.5		-0.9	
Gate-source leakage	I_{GSS}	$V_{DS} = 0V, V_{GS} = \pm 8V$			± 100	nA
Zero gate voltage drain current	I_{DSS}	$V_{DS} = -8V, V_{GS} = 0V$			-1	μA
Drain-source on-state resistance ^a	$R_{DS(on)}$	$V_{GS} = -4.5V, I_D = -3.5A$		30	45	m Ω
		$V_{GS} = -2.5V, I_D = -3A$		40	60	
		$V_{GS} = -1.8V, I_D = -2.0A$		60	90	
Forward transconductance ^a	g_{fs}	$V_{DS} = -5V, I_D = -4.1A$	6			S
Dynamic						
Input capacitance ^{b,c}	C_{iss}	$V_{DS} = -4V, V_{GS} = 0V, f = 1MHz$		740		pF
Output capacitance ^{b,c}	C_{oss}			290		
Reverse transfer capacitance ^{b,c}	C_{rss}			190		
Total gate charge ^b	Q_g	$V_{DS} = -4V, V_{GS} = -4.5V, I_D = -4.1A$		7.8	15	nC
		$V_{DS} = -4V, V_{GS} = -2.5V, I_D = -4.1A$		4.5	9	
Gate-source charge ^b	Q_{gs}			1.2		
Gate-drain charge ^b	Q_{gd}			1.6		
Gate resistance ^{b,c}	R_g	$f = 1MHz$	1.4	7	14	Ω
Turn-on delay time ^{b,c}	$t_{d(on)}$	$V_{DD} = -4V, R_L = 1.2\Omega, I_D \approx -3.3A, V_{GEN} = -4.5V, R_g = 1\Omega$		13	20	ns
Rise time ^{b,c}	t_r			35	53	
Turn-off Delay time ^{b,c}	$t_{d(off)}$			32	48	
Fall time ^{b,c}	t_f			10	20	
Turn-on delay time ^{b,c}	$t_{d(on)}$	$V_{DD} = -4V, R_L = 1.2\Omega, I_D \approx -3.3A, V_{GEN} = -8V, R_g = 1\Omega$		5	10	
Rise time ^{b,c}	t_r			11	17	
Turn-off delay time ^{b,c}	$t_{d(off)}$			22	33	
Fall time ^{b,c}	t_f			16	24	
Drain-source body diode characteristics						
Continuous source-drain diode current	I_S	$T_C = 25^\circ C$			-1.4	A
Pulse diode forward current ^a	I_{SM}				-10	
Body diode voltage	V_{SD}	$I_F = -3.3A$			-1.2	V

Note :

- a. Pulse Test ; Pulse Width $\leq 300\mu s$, Duty Cycle $\leq 2\%$.
- b. Guaranteed by design, not subject to production testing.
- c. These parameters have no way to verify.

Typical Characteristics

Output Characteristics

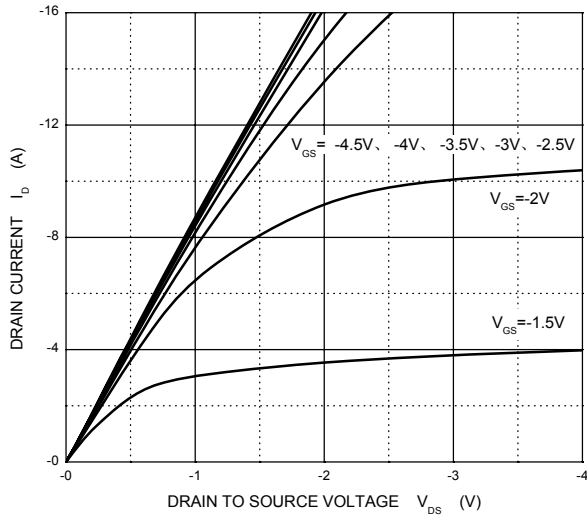

Transfer Characteristics

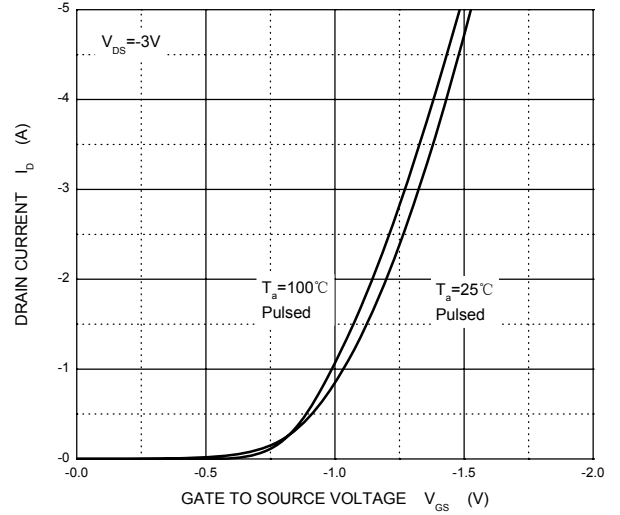

$R_{DS(ON)}$ — I_D

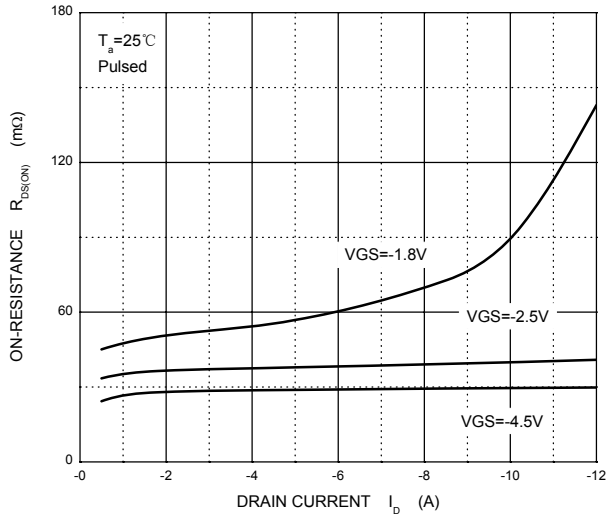

$R_{DS(ON)}$ — V_{GS}

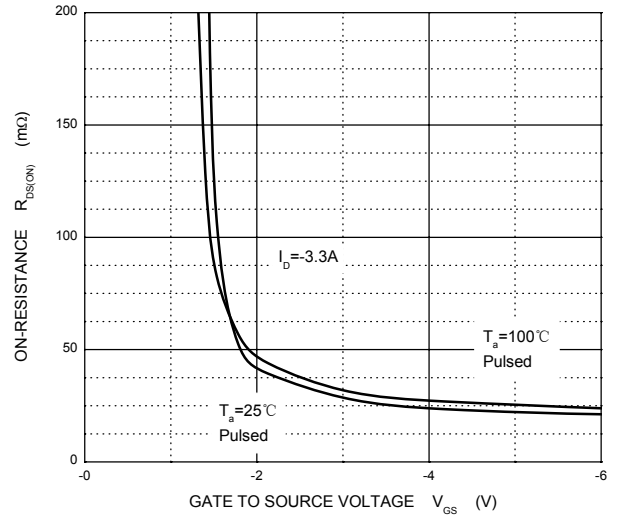

I_S — V_{SD}

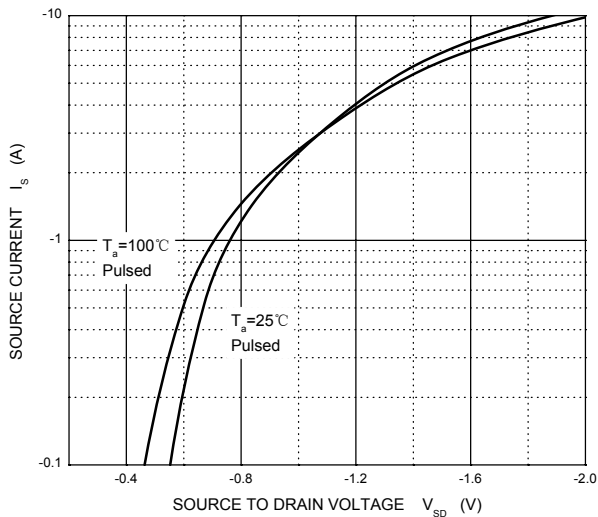

Threshold Voltage

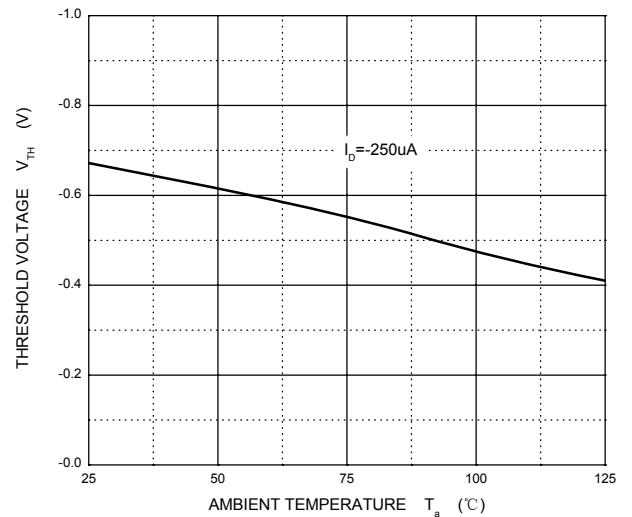

SOT-23-6L Package Outline Dimensions

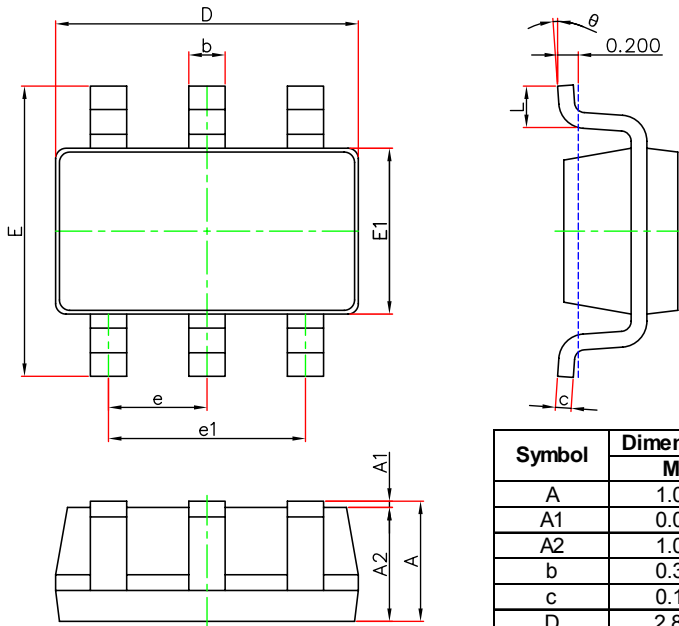

Symbol	Dimensions In Millimeters		Dimensions In Inches	
	Min.	Max.	Min.	Max.
A	1.050	1.250	0.041	0.049
A1	0.000	0.100	0.000	0.004
A2	1.050	1.150	0.041	0.045
b	0.300	0.500	0.012	0.020
c	0.100	0.200	0.004	0.008
D	2.820	3.020	0.111	0.119
E1	1.500	1.700	0.059	0.067
E	2.650	2.950	0.104	0.116
e	0.950(BSC)		0.037(BSC)	
e1	1.800	2.000	0.071	0.079
L	0.300	0.600	0.012	0.024
θ	0°	8°	0°	8°

SOT-23-6L Suggested Pad Layout

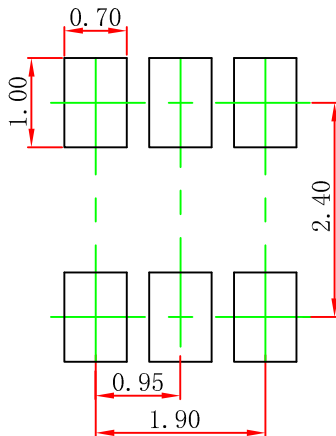

- Note:
1. Controlling dimension: in millimeters.
 2. General tolerance: ± 0.05 mm.
 3. The pad layout is for reference purposes only.

NOTICE

JSCJ reserves the right to make modifications, enhancements, improvements, corrections or other changes without further notice to any product herein. JSCJ does not assume any liability arising out of the application or use of any product described herein.

SOT-23-6L Tape and Reel

SOT-23-6L Embossed Carrier Tape

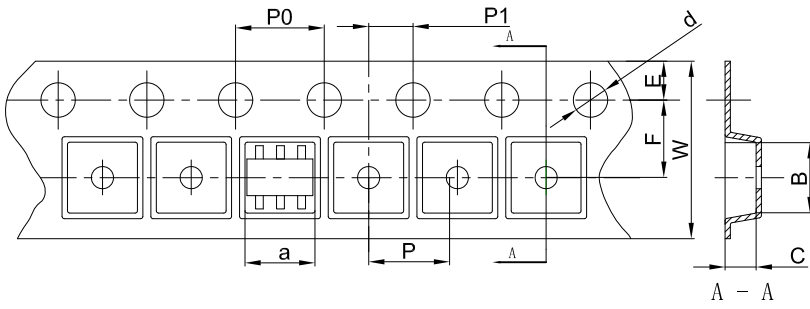

Packaging Description:

SOT-23-6L parts are shipped in tape. The carrier tape is made from a dissipative (carbon filled) polycarbonate resin. The cover tape is a multilayer film (Heat Activated Adhesive in nature) primarily composed of polyester film, adhesive layer, sealant, and anti-static sprayed agent. These reeled parts in standard option are shipped with 3,000 units per 7" or 18.0cm diameter reel. The reels are clear in color and is made of polystyrene plastic (anti-static coated).

Dimensions are in millimeter										
Pkg type	a	B	C	d	E	F	P0	P	P1	W
SOT-23-6L	3.17	3.23	1.37	Ø1.55	1.75	3.50	4.00	4.00	2.00	8.00

SOT-23-6L Tape Leader and Trailer

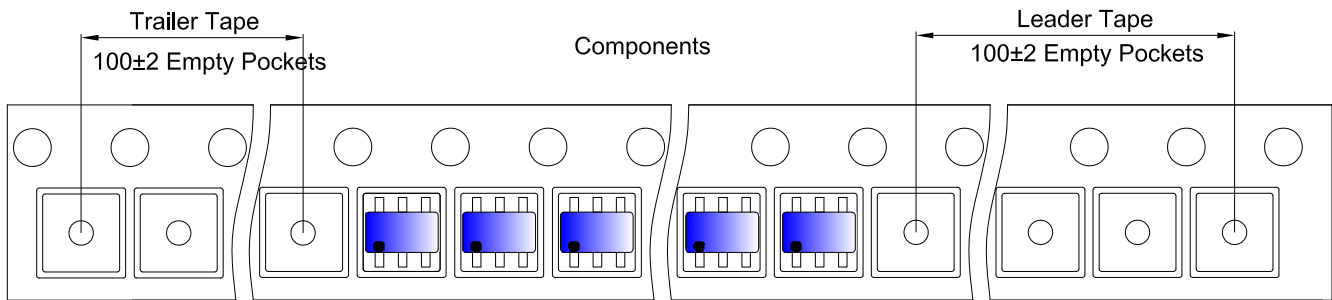

SOT-23-6L Reel

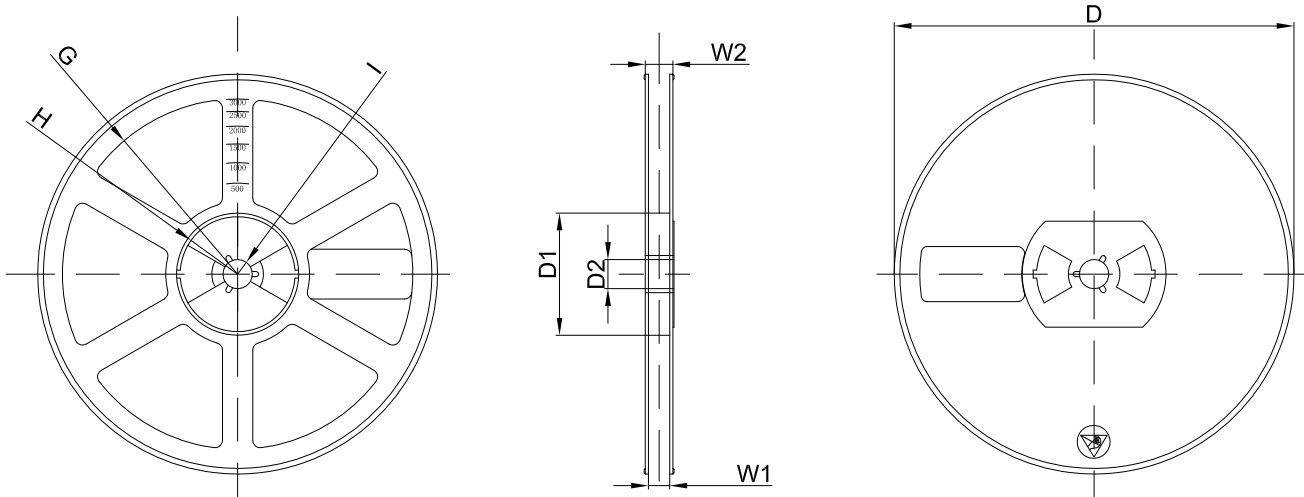

Dimensions are in millimeter								
Reel Option	D	D1	D2	G	H	I	W1	W2
7"Dia	Ø180.00	60.00	13.00	R78.00	R25.60	R6.50	9.50	13.10

REEL	Reel Size	Box	Box Size(mm)	Carton	Carton Size(mm)	G.W.(kg)
3000 pcs	7 inch	30,000 pcs	203×203×195	120,000 pcs	438×438×220	