

## PNP General Purpose Amplifier

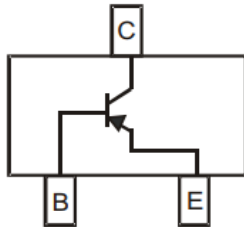

**SOT-23**

### Features

- Epoxy meets UL-94 V-0 flammability rating and halogen free
- Moisture Sensitivity Level 1
- Part no. with suffix "Q" means AEC-Q101 qualified

### Applications

- Switching and linear amplification

### Mechanical Data

- **Case:** SOT-23
- **Terminals:** Tin plated leads, solderable per J-STD-002 and JESD22-B102
- **Marking:** 2L

### ■ Maximum Ratings (Ta=25°C unless otherwise noted)

Item	Symbol	Unit	Conditions	Value
Collector-Emitter Voltage	$V_{CEO}$	V		-160
Collector-Base Voltage	$V_{CBO}$	V		-180
Emitter-Base Voltage	$V_{EBO}$	V		-6.0
Collector Current -Continuous	$I_C$	mA		-600
Total Device Dissipation	$P_D$	mW		300
Thermal Resistance Junction to Ambient	$R_{thJA}$	K/W		416
Maximum Junction Temperature	$T_J$	°C		150
Storage Temperature	$T_{STG}$	°C		-55 to +150



# MMBT5401Q

RoHS  
COMPLIANT

## ■ Electrical Characteristics (Ta=25°C unless otherwise noted)

Item	Symbol	Unit	Conditions	Min	Max
Collector-emitter breakdown voltage	$V_{(BR)CEO}$	V	$I_C = -1.0mA, I_B = 0$	-160	
Collector-base breakdown voltage	$V_{(BR)CBO}$	V	$I_C = -100\mu A, I_E = 0$	-180	
Emitter-base breakdown voltage	$V_{(BR)EBO}$	V	$I_E = -10\mu A, I_C = 0$	-6.0	
Collector cut-off current	$I_{CBO}$	nA	$V_{CB} = -120V$		-50
Collector cut-off current	$I_{EBO}$	nA	$V_{CE} = -4.0V$		-50
DC current gain	$h_{FE}$		$V_{CE} = -5.0V, I_C = -1.0mA$	80	
	$h_{FE}$		$V_{CE} = -5.0V, I_C = -10mA$	100	300
	$h_{FE}$		$V_{CE} = -5.0V, I_C = -50mA$	50	
Collector-emitter saturation voltage	$V_{CE(sat)}$	V	$I_C = -50mA, I_B = -5.0mA$		-0.5
Base-emitter saturation voltage	$V_{BE(sat)}$	V	$I_C = -50mA, I_B = -5.0mA$		-1.0
Transition frequency	$f_T$	MHz	$V_{CE} = -5V, I_C = -10mA, f = 30MHz$	100	300

## ■ Ordering Information (Example)

PREFERRED P/N	PACKING CODE	UNIT WEIGHT(g)	MINIMUM PACKAGE(pcs)	INNER BOX QUANTITY(pcs)	OUTER CARTON QUANTITY(pcs)	DELIVERY MODE
MMBT5401Q	F2	Approximate 0.01	3000	30000	120000	7" reel



## ■ Characteristics (Typical)

Figure 1. Static Characteristic

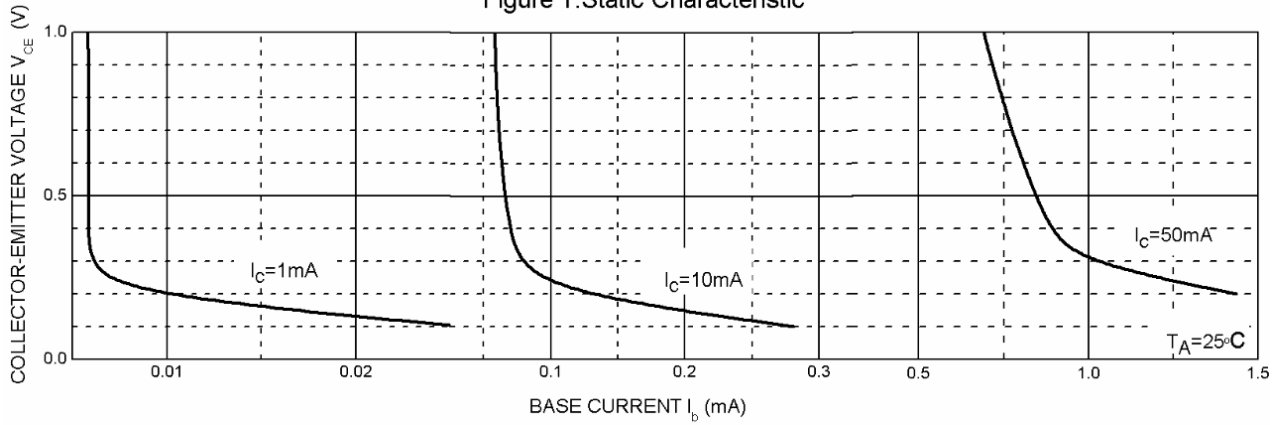

Figure 2.  $h_{FE} - I_c$

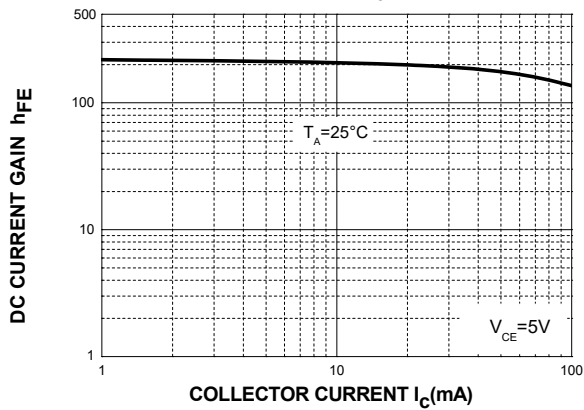

Figure 3.  $V_{\text{besat}} - I_c$

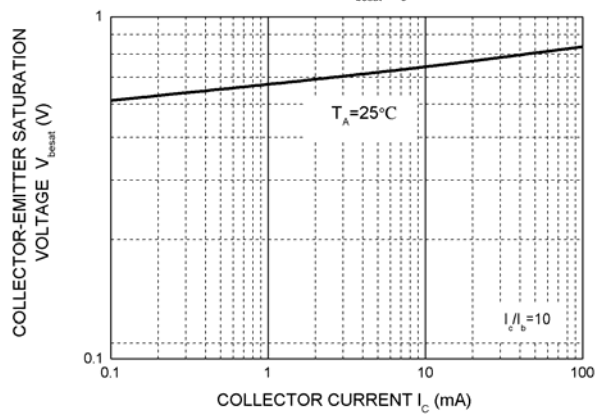
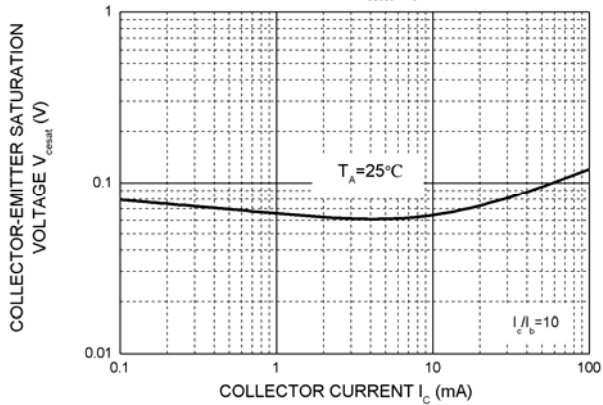
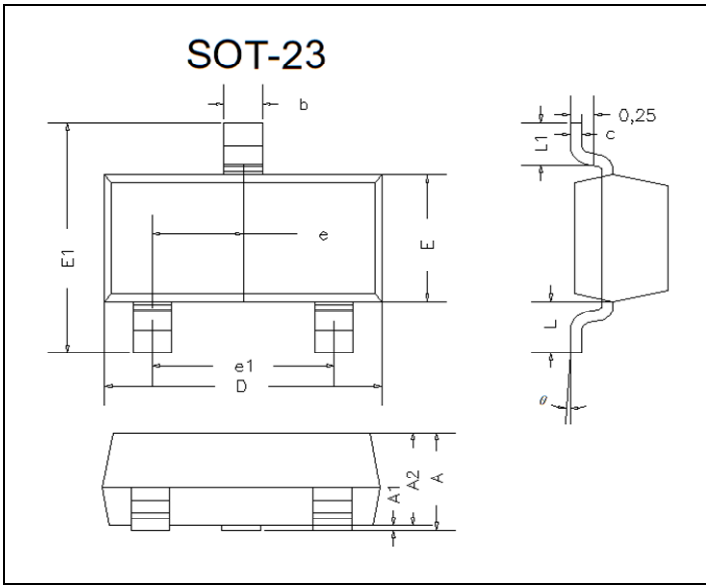

Figure 4.  $V_{\text{cesat}} - I_c$



## ■ SOT-23 Package Outline Dimensions



DIM	INCHES		MM		NOTE
	MIN	MAX	MIN	MAX	
A	0.035	0.045	0.90	1.15	
A1	0.000	0.004	0.00	0.10	
A2	0.035	0.041	0.90	1.05	
b	0.012	0.020	0.30	0.50	
c	0.004	0.008	0.10	0.20	
D	0.110	0.118	2.80	3.00	
E	0.047	0.055	1.20	1.40	
E1	0.089	0.100	2.25	2.55	
e	0.370TYP		0.95TYP		
e1	0.071	0.079	1.80	2.00	
L	0.220REF		0.55REF		
L1	0.012	0.020	0.30	0.50	
theta	0°	8°	0°	8°	

## ■ SOT-23 Suggested Pad Layout

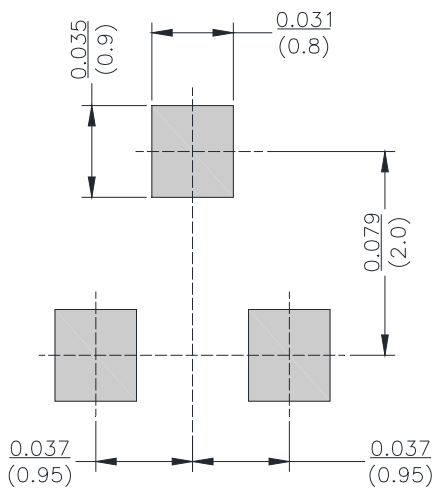

Unit:  $\frac{\text{inch}}{\text{mm}}$



## Disclaimer

The information presented in this document is for reference only. Yangzhou Yangjie Electronic Technology Co., Ltd. reserves the right to make changes without notice for the specification of the products displayed herein to improve reliability, function or design or otherwise.

The product listed herein is designed to be used with automotive electronics, are not designed for use in medical, life-saving, lifesustaining, or military. Yangjie or anyone on its behalf, assumes no responsibility or liability for any damages resulting from such improper use of sale.

This publication supersedes & replaces all information previously supplied. For additional information, please visit our website [http:// www.21yangjie.com](http://www.21yangjie.com) , or consult your nearest Yangjie's sales office for further assistance.