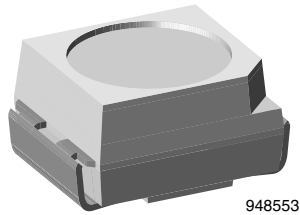


Standard SMD LED PLCC-2



948553

DESCRIPTION

These devices have been designed to meet the increasing demand for surface mounting technology.

The package of the VLM.310. is the PLCC-2.

It consists of a lead frame which is embedded in a white thermoplast. The reflector inside this package is filled up with clear epoxy.

PRODUCT GROUP AND PACKAGE DATA

- Product group: LED
- Package: SMD PLCC-2
- Product series: standard
- Angle of half intensity: $\pm 60^\circ$

FEATURES

- SMD LEDs with exceptional brightness
- Luminous intensity categorized
- Compatible with automatic placement equipment
- EIA and ICE standard package
- Compatible with infrared, vapor phase and wave solder processes according to CECC 00802 and J-STD-020
- Available in 8 mm tape
- Low profile package
- Non-diffused lens: excellent for coupling to light pipes and backlighting
- Low power consumption
- Luminous intensity ratio in one packaging unit $I_{Vmax}/I_{Vmin.} \leq 1.6$
- Preconditioning according to JEDEC® level 2a
- Material categorization: for definitions of compliance please see www.vishay.com/doc?99912



APPLICATIONS

- Telecommunication: indicator and backlighting in telephone and fax
- Indicator and backlight for audio and video equipment
- Indicator and backlight in office equipment
- Flat backlight for LCDs, switches, and symbols
- General use

PARTS TABLE														
PART	COLOR	LUMINOUS INTENSITY (mcd)			at I _F (mA)	WAVELENGTH (nm)			at I _F (mA)	FORWARD VOLTAGE (V)			at I _F (mA)	TECHNOLOGY
		MIN.	TYP.	MAX.		MIN.	TYP.	MAX.		MIN.	TYP.	MAX.		
VLMH3100-GS08	Amber	2.8	12	-	10	612	619	625	10	-	2	2.8	20	GaAsP on GaP
VLMH3100-GS18	Amber	2.8	12	-	10	612	619	625	10	-	2	2.8	20	GaAsP on GaP
VLMH3102-GS08	Amber	7.1	12	18	10	612	619	625	10	-	2	2.8	20	GaAsP on GaP
VLMO3100-GS08	Soft orange	2.8	8	-	10	598	605	611	10	-	2	2.8	20	GaAsP on GaP
VLMY3100-GS08	Yellow	2.8	11	-	10	581	588	594	10	-	2.1	2.8	20	GaAsP on GaP
VLMY3101-GS08	Yellow	4.5	10	11.2	10	581	588	594	10	-	2.1	2.8	20	GaAsP on GaP
VLMY3102-GS08	Yellow	7.1	11	18	10	581	588	594	10	-	2.1	2.8	20	GaAsP on GaP
VLMG3100-GS08	Green	4.5	16	-	10	562	572	575	10	-	2.1	2.8	20	GaP on GaP
VLMG3100-GS18	Green	4.5	16	-	10	562	572	575	10	-	2.1	2.8	20	GaP on GaP
VLMG3102-GS08	Green	11.2	16	18	10	562	572	575	10	-	2.1	2.8	20	GaP on GaP
VLMG3105-GS08	Green	7.1	16	18	10	562	572	575	10	-	2.1	2.8	20	GaP on GaP

**ABSOLUTE MAXIMUM RATINGS** ($T_{amb} = 25\text{ }^{\circ}\text{C}$, unless otherwise specified)
VLMG310., VLMH310., VLMO310., VLMY310.

PARAMETER	TEST CONDITION	SYMBOL	VALUE	UNIT
Reverse voltage		V_R	6	V
DC forward current	$T_{amb} \leq 74\text{ }^{\circ}\text{C}$	I_F	20	mA
Surge forward current	$t_p \leq 10\text{ }\mu\text{s}$	I_{FSM}	0.34	A
Power dissipation		P_V	56	mW
Junction temperature		T_j	100	$^{\circ}\text{C}$
Operating temperature range		T_{amb}	-40 to +100	$^{\circ}\text{C}$
Storage temperature range		T_{stg}	-40 to +100	$^{\circ}\text{C}$
Soldering temperature	$t \leq 5\text{ s}$	T_{sd}	260	$^{\circ}\text{C}$
Thermal resistance junction to ambient	Mounted on PC board (pad size > 16 mm ²)	R_{thJA}	400	K/W

OPTICAL AND ELECTRICAL CHARACTERISTICS ($T_{amb} = 25\text{ }^{\circ}\text{C}$, unless otherwise specified)
VLMH310., AMBER

PARAMETER	TEST CONDITION	PART	SYMBOL	MIN.	TYP.	MAX.	UNIT
Luminous intensity ⁽¹⁾	$I_F = 10\text{ mA}$	VLMH3100	I_V	2.8	12	-	mcd
		VLMH3102	I_V	7.1	12	18	mcd
Dominant wavelength	$I_F = 10\text{ mA}$		λ_d	612	619	625	nm
Peak wavelength	$I_F = 10\text{ mA}$		λ_p	-	635	-	nm
Angle of half intensity	$I_F = 10\text{ mA}$		ϕ	-	± 60	-	$^{\circ}$
Forward voltage	$I_F = 20\text{ mA}$		V_F	-	2	2.8	V
Reverse current	$V_R = 6\text{ V}$		I_R	-	-	10	μA
Junction capacitance	$V_R = 0\text{ V}$, $f = 1\text{ MHz}$		C_j	-	15	-	pF

Note⁽¹⁾ In one packing unit $I_{Vmax}/I_{Vmin} \leq 1.6$ **OPTICAL AND ELECTRICAL CHARACTERISTICS** ($T_{amb} = 25\text{ }^{\circ}\text{C}$, unless otherwise specified)
VLMO310., SOFT ORANGE

PARAMETER	TEST CONDITION	PART	SYMBOL	MIN.	TYP.	MAX.	UNIT
Luminous intensity ⁽¹⁾	$I_F = 10\text{ mA}$	VLMO3100	I_V	2.8	8	-	mcd
Dominant wavelength	$I_F = 10\text{ mA}$		λ_d	598	605	611	nm
Peak wavelength	$I_F = 10\text{ mA}$		λ_p	-	605	-	nm
Angle of half intensity	$I_F = 10\text{ mA}$		ϕ	-	± 60	-	$^{\circ}$
Forward voltage	$I_F = 20\text{ mA}$		V_F	-	2	2.8	V
Reverse current	$V_R = 6\text{ V}$		I_R	-	-	10	μA
Junction capacitance	$V_R = 0\text{ V}$, $f = 1\text{ MHz}$		C_j	-	15	-	pF

Note⁽¹⁾ In one packing unit $I_{Vmax}/I_{Vmin} \leq 1.6$

**OPTICAL AND ELECTRICAL CHARACTERISTICS** ($T_{amb} = 25\text{ }^{\circ}\text{C}$, unless otherwise specified)
VLMY310., YELLOW

PARAMETER	TEST CONDITION	PART	SYMBOL	MIN.	TYP.	MAX.	UNIT
Luminous intensity ⁽¹⁾	$I_F = 10\text{ mA}$	VLMY3100	I_V	2.8	11		mcd
		VLMY3101	I_V	4.5	10	11.2	mcd
		VLMY3102	I_V	7.1	11	18	mcd
Dominant wavelength	$I_F = 10\text{ mA}$		λ_d	581	588	594	nm
Peak wavelength	$I_F = 10\text{ mA}$		λ_p	-	585	-	nm
Angle of half intensity	$I_F = 10\text{ mA}$		ϕ	-	± 60	-	$^{\circ}$
Forward voltage	$I_F = 20\text{ mA}$		V_F	-	2.1	2.8	V
Reverse current	$V_R = 6\text{ V}$		I_R	-	-	10	μA
Junction capacitance	$V_R = 0\text{ V}$, $f = 1\text{ MHz}$		C_j	-	15	-	pF

Note(1) In one packing unit $I_{Vmax}/I_{Vmin.} \leq 1.6$ **OPTICAL AND ELECTRICAL CHARACTERISTICS** ($T_{amb} = 25\text{ }^{\circ}\text{C}$, unless otherwise specified)
VLMG310., GREEN

PARAMETER	TEST CONDITION	PART	SYMBOL	MIN.	TYP.	MAX.	UNIT
Luminous intensity ⁽¹⁾	$I_F = 10\text{ mA}$	VLMG3100	I_V	4.5	16	-	mcd
		VLMG3102	I_V	11.2	16	18	mcd
		VLMG3105	I_V	7.1	16	18	mcd
Dominant wavelength	$I_F = 10\text{ mA}$		λ_d	562	572	575	nm
Peak wavelength	$I_F = 10\text{ mA}$		λ_p	-	565	-	nm
Angle of half intensity	$I_F = 10\text{ mA}$		ϕ	-	± 60	-	$^{\circ}$
Forward voltage	$I_F = 20\text{ mA}$		V_F	-	2.1	2.8	V
Reverse current	$V_R = 6\text{ V}$		I_R	-	-	10	μA
Junction capacitance	$V_R = 0\text{ V}$, $f = 1\text{ MHz}$		-	-	15	-	pF

Note(1) In one packing unit $I_{Vmax}/I_{Vmin.} \leq 1.6$ **COLOR CALSSIFICATION**

GROUP	YELLOW		GREEN		SOFT ORANGE	
	DOM. WAVELENGTH (nm)				DOM. WAVELENGTH (nm)	
	MIN.	MAX.	MIN.	MAX.	MIN.	MAX.
0	-	-	-	-	-	-
1	581	584	-	-	598	601
2	583	586	-	-	600	603
3	585	588	-	-	602	605
4	587	590	564	567	604	607
5	589	592	566	569	606	609
6	591	594	568	571	608	611
7	-	-	570	573	-	-
8	-	-	572	575	-	-

Note

- Wavelengths are tested at a current pulse duration of 25 ms



LUMINOUS INTENSITY CLASSIFICATION			
GROUP	LIGHT INTENSITY (mcd)		
STANDARD	OPTIONAL	MIN.	MAX.
F	1	1.12	1.40
	2	1.40	1.80
G	1	1.80	2.24
	2	2.24	2.80
H	1	2.80	3.55
	2	3.55	4.50
J	1	4.50	5.60
	2	5.60	7.10
K	1	7.10	9.00
	2	9.00	11.20
L	1	11.20	14.00
	2	14.00	18.00
M	1	18.00	22.40
	2	22.40	28.00

Note

- Luminous intensity is tested at a current pulse duration of 25 ms and an accuracy of ± 11 %.
- The above type numbers represent the order groups which include only a few brightness groups. Only one group will be shipped on each reel (there will be no mixing of two groups on each reel).
- In order to ensure availability, single brightness groups will not be orderable.
- In a similar manner for colors where wavelength groups are measured and binned, single wavelength groups will be shipped on any one reel.
- In order to ensure availability, single wavelength groups will not be orderable

CROSSING TABLE		
VISHAY	OSRAM	STANLEY
VLMH3100	-	-
VLMH3101	-	-
VLMH3102	-	-
VLMO3100	LOT670J1L2	-
VLMO3101	LOT670J1K2	-
VLMY3100	LYT670J1L2	-
VLMY3101	LYT670J1K2	-
VLMY3102	LYT670K1L2	-
VLMG3100	LGT670K1M2	VYBG1104B
VLMG3102	LGT670L1L2	-
VLMG3105	LGT671K1L2	-

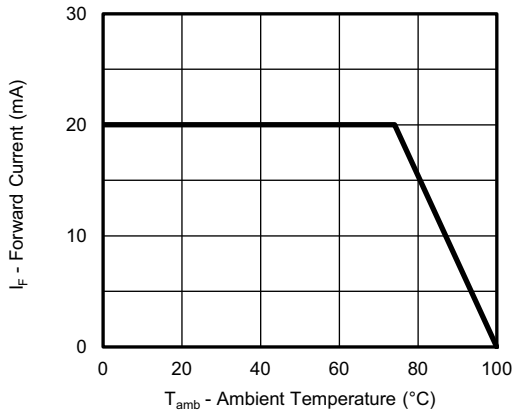
TYPICAL CHARACTERISTICS ($T_{amb} = 25\text{ }^{\circ}\text{C}$, unless otherwise specified)


Fig. 1 - Maximum Permissible Forward Current vs. Ambient Temperature

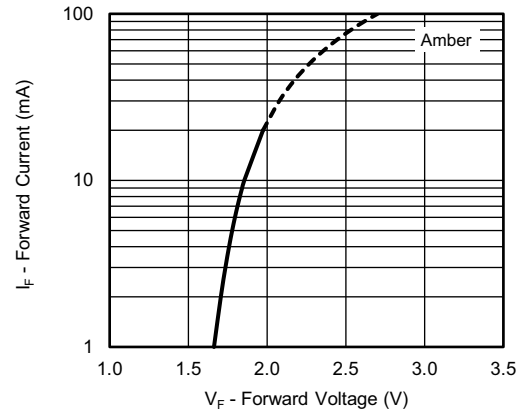


Fig. 4 - Forward Current vs. Forward Voltage

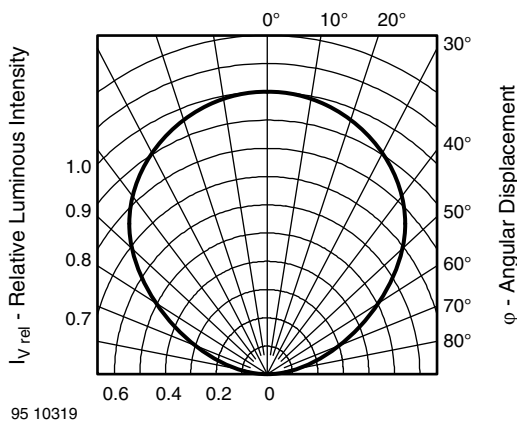


Fig. 2 - Relative Luminous Intensity vs. Angular Displacement

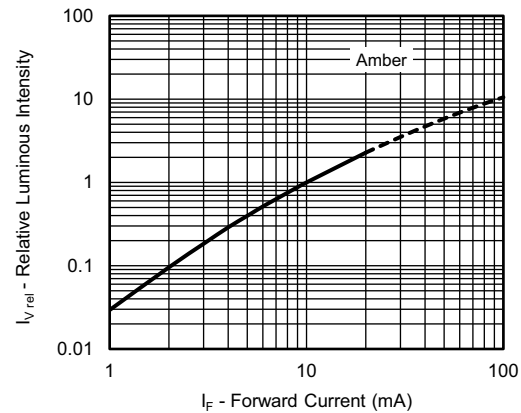


Fig. 5 - Relative Luminous Intensity vs. Forward Current

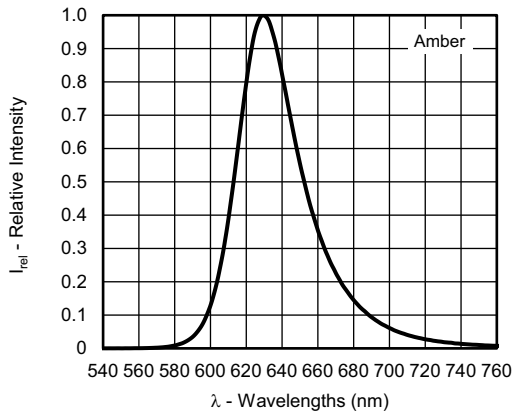


Fig. 3 - Relative Intensity vs. Wavelength

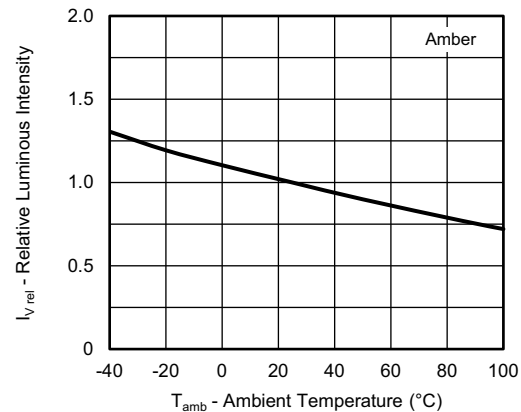


Fig. 6 - Relative Luminous Intensity vs. Ambient Temperature

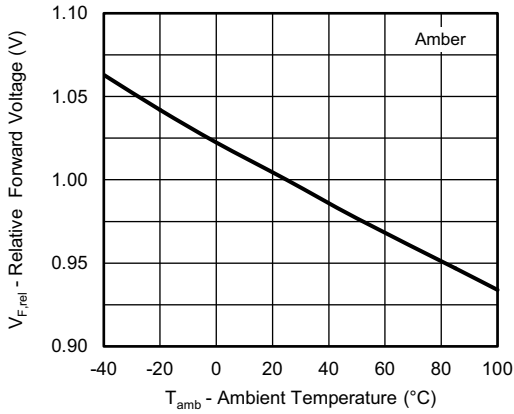


Fig. 7 - Relative Forward Voltage vs. Ambient Temperature

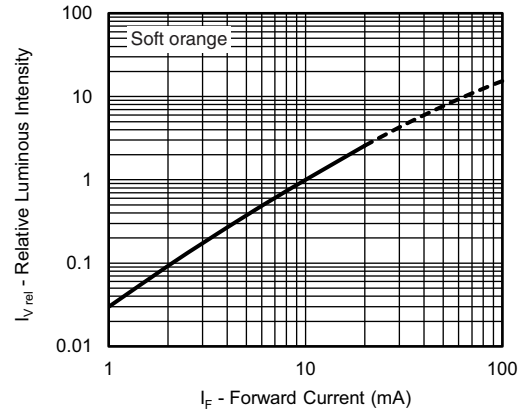


Fig. 10 - Relative Luminous Intensity vs. Forward Current

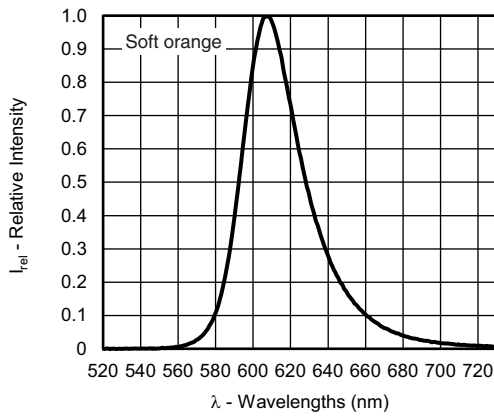


Fig. 8 - Relative Intensity vs. Wavelength

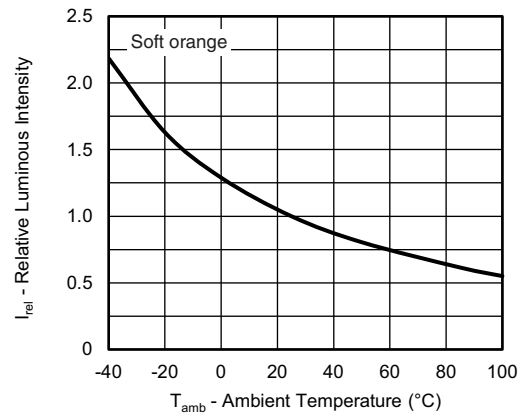


Fig. 11 - Relative Luminous Intensity vs. Ambient Temperature

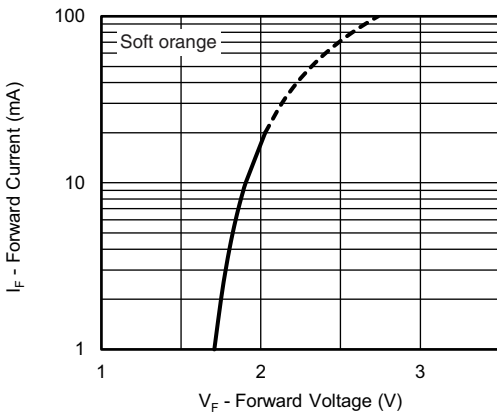


Fig. 9 - Forward Current vs. Forward Voltage

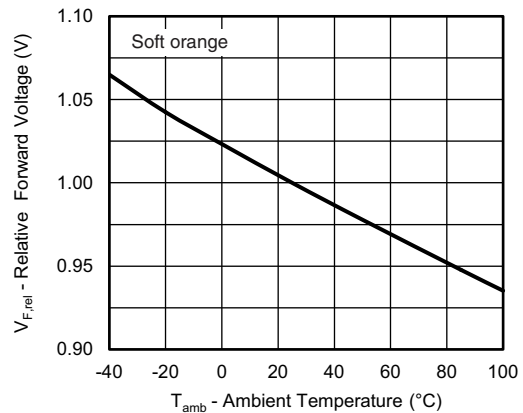


Fig. 12 - Relative Forward Voltage vs. Ambient Temperature

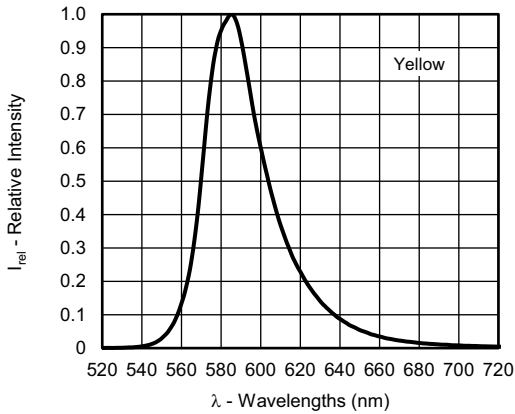


Fig. 13 - Relative Intensity vs. Wavelength

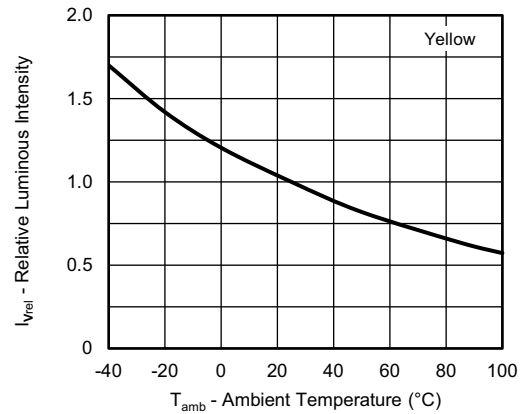


Fig. 16 - Relative Luminous Intensity vs. Ambient Temperature

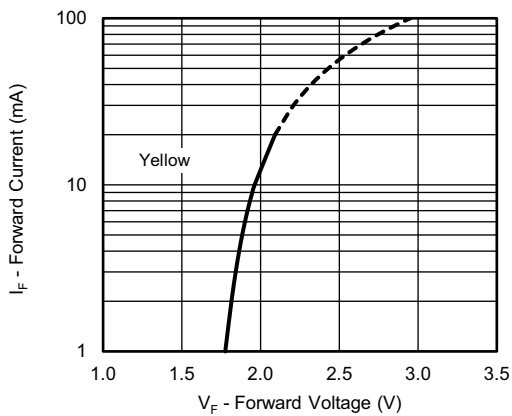


Fig. 14 - Forward Current vs. Forward Voltage

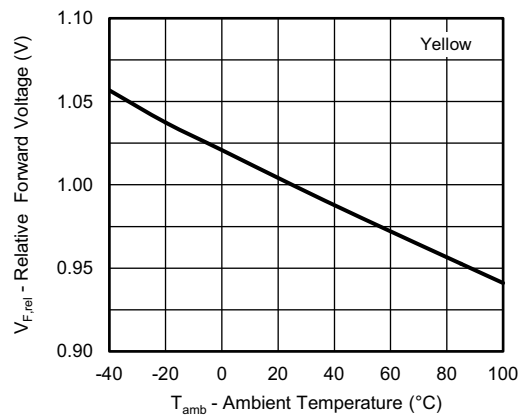


Fig. 17 - Relative Forward Voltage vs. Ambient Temperature

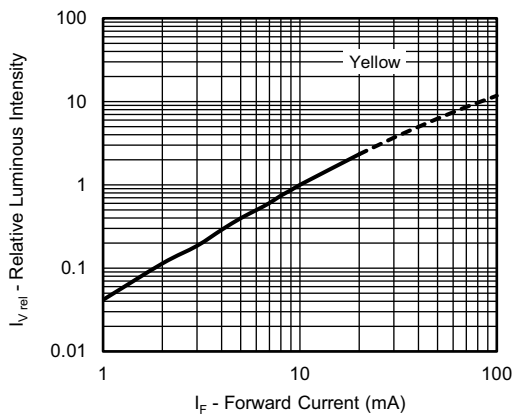


Fig. 15 - Relative Luminous Intensity vs. Forward Current

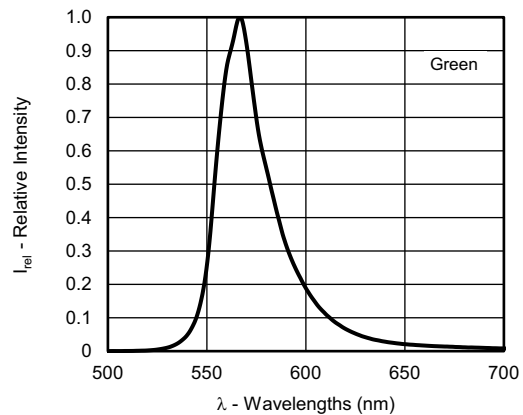


Fig. 18 - Relative Intensity vs. Wavelength

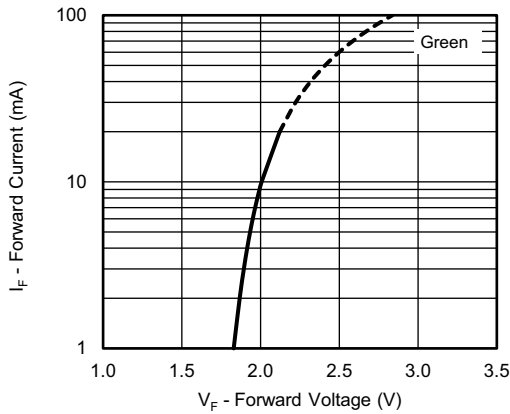


Fig. 19 - Forward Current vs. Forward Voltage

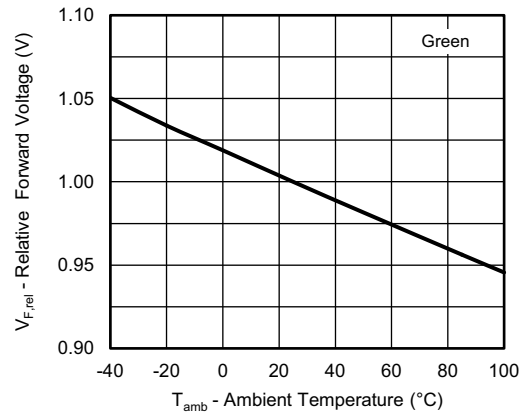


Fig. 22 - Relative Forward Voltage vs. Ambient Temperature

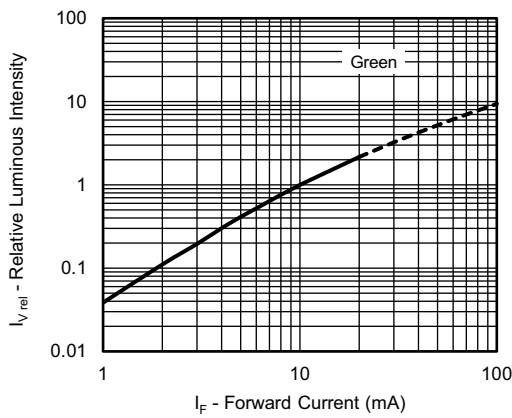


Fig. 20 - Relative Luminous Intensity vs. Forward Current

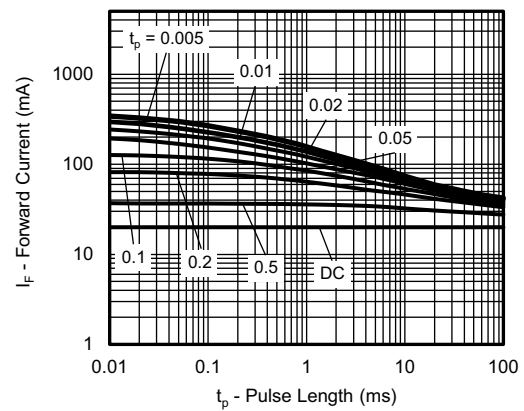


Fig. 23 - Permissible Pulse Forward Current vs. Pulse Duration

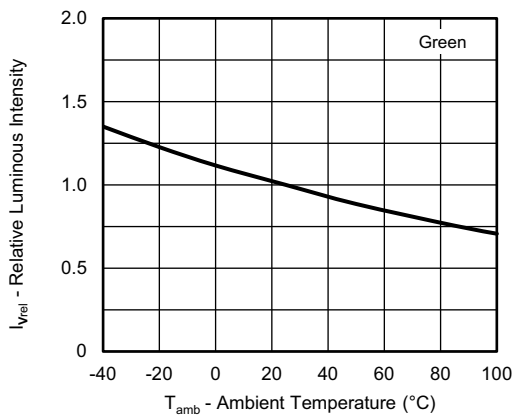
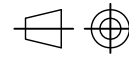
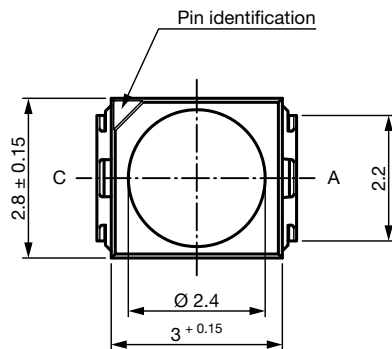
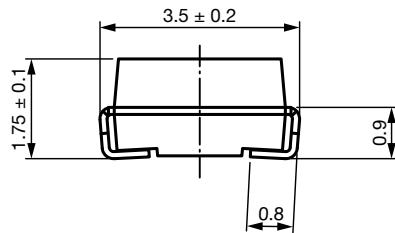


Fig. 21 - Relative Luminous Intensity vs. Ambient Temperature

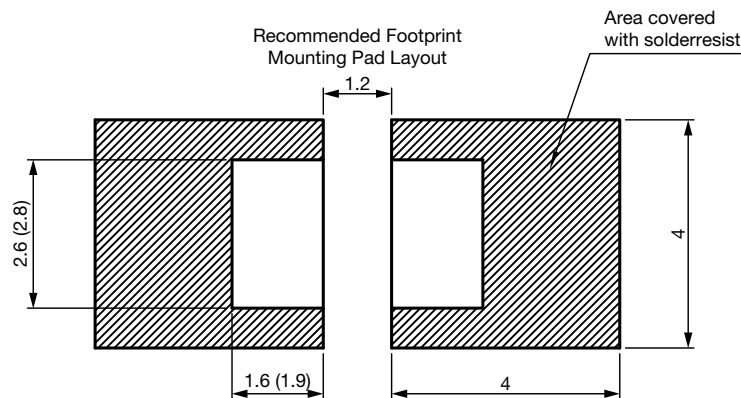


PACKAGE DIMENSIONS in millimeters



technical drawings
according to DIN
specifications

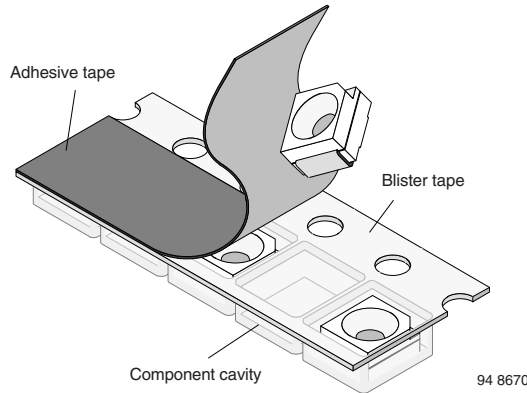
Drawing-No.: 6.541-5067.01-4
Issue: 7; 12.03.14



METHOD OF TAPING / POLARITY AND TAPE AND REEL

SMD LED (VLM.3-SERIES)

Vishay's LEDs in SMD packages are available in an antistatic 8 mm blister tape (in accordance with DIN IEC 40 (CO) 564) for automatic component insertion. The blister tape is a plastic strip with impressed component cavities, covered by a top tape.



REEL PACKAGE DIMENSION IN MILLIMETERS FOR SMD LEDs, TAPE OPTION GS18 (= 8000 PCS.) PREFERRED

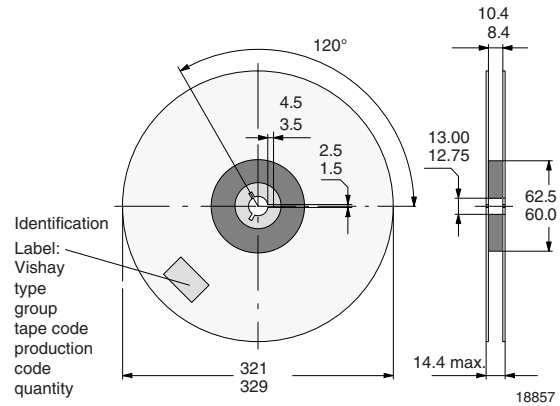


Fig. 26 - Reel Dimensions - GS18

TAPING OF VLM.3...

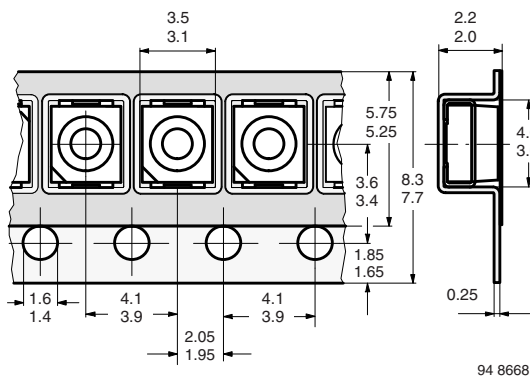


Fig. 24 - Tape Dimensions in mm for PLCC-2

SOLDERING PROFILE

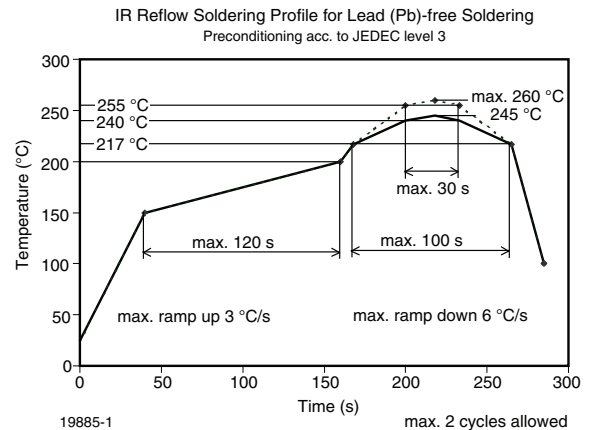


Fig. 27 - Vishay Lead (Pb)-free Reflow Soldering Profile (according to J-STD-020)

REEL PACKAGE DIMENSION IN MILLIMETERS FOR SMD LEDs, TAPE OPTION GS08 (= 1500 PCS.)

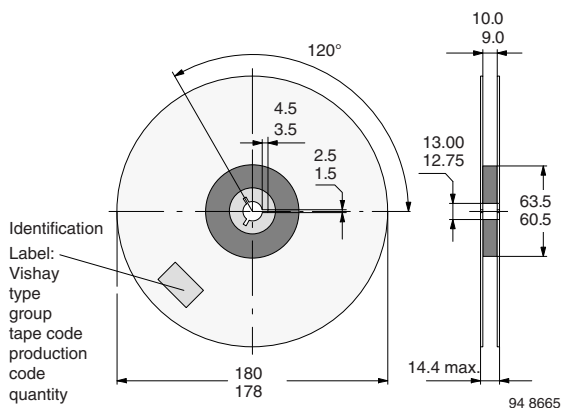


Fig. 25 - Reel Dimensions - GS08

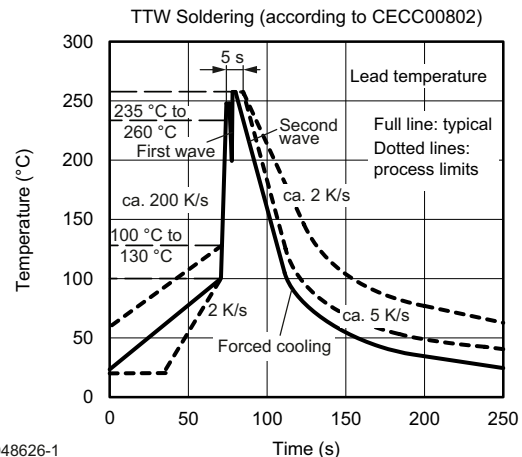
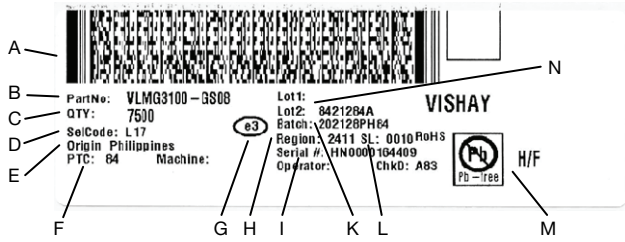


Fig. 28 - Double Wave Soldering of Opto Devices (all packages)



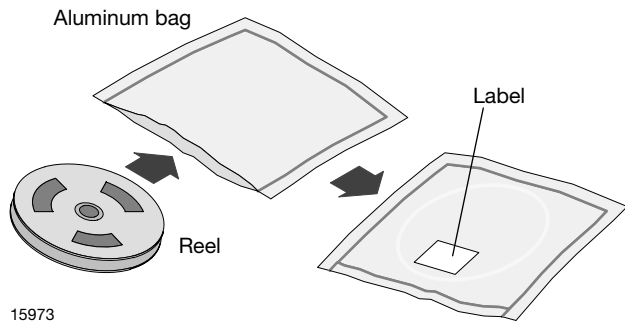
BAR CODE PRODUCT LABEL (example)



- A. 2D barcode
- B. Part No: Vishay part number
- C. QTY: quantity
- D. SelCode: selection bin code
- E. Country of origin
- F. PTC: production plant code
- G. Termination finish
- H. Region code
- I. Serial#: serial number
- K. Batch Number: year, week, country code, plant code
- L. SL: storage location
- M. Environmental Symbols: RoHS, lead (Pb)-free, halogen free
- N. Lot numbers

DRY PACKING

The reel is packed in an anti-humidity bag to protect the devices from absorbing moisture during transportation and storage.



FINAL PACKING

The sealed reel is packed into a cardboard box. A secondary cardboard box is used for shipping purposes.

RECOMMENDED METHOD OF STORAGE

Dry box storage is recommended as soon as the aluminum bag has been opened to prevent moisture absorption. The following conditions should be observed, if dry boxes are not available:

- Storage temperature 10 °C to 30 °C
- Storage humidity ≤ 60 % RH max.

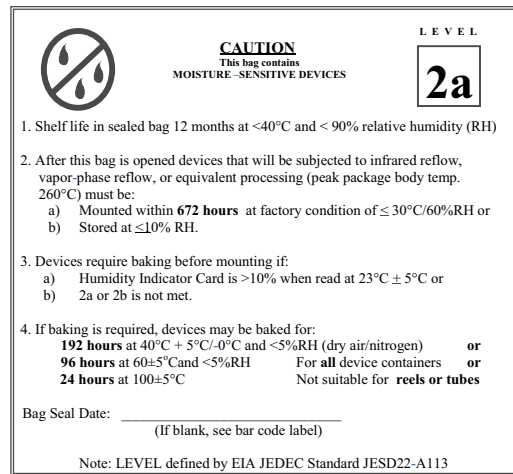
After more than 672 h under these conditions moisture content will be too high for reflow soldering.

In case of moisture absorption, the devices will recover to the former condition by drying under the following condition: 192 h at 40 °C + 5 °C / - 0 °C and < 5 % RH (dry air / nitrogen) or

96 h at 60 °C + 5 °C and < 5 % RH for all device containers or

24 h at 100 °C + 5 °C not suitable for reel or tubes.

An EIA JEDEC standard JESD22-A112 level 2a label is included on all dry bags.



Example of JESD22-A112 level 2a label

ESD PRECAUTION

Proper storage and handling procedures should be followed to prevent ESD damage to the devices especially when they are removed from the antistatic shielding bag. Electrostatic sensitive devices warning labels are on the packaging.

VISHAY SEMICONDUCTORS STANDARD BAR CODE LABEL

The Vishay Semiconductors standard bar code labels are printed at final packing areas. The labels are on each packing unit and contain Vishay Semiconductors specific data.



Disclaimer

ALL PRODUCT, PRODUCT SPECIFICATIONS AND DATA ARE SUBJECT TO CHANGE WITHOUT NOTICE TO IMPROVE RELIABILITY, FUNCTION OR DESIGN OR OTHERWISE.

Vishay Intertechnology, Inc., its affiliates, agents, and employees, and all persons acting on its or their behalf (collectively, "Vishay"), disclaim any and all liability for any errors, inaccuracies or incompleteness contained in any datasheet or in any other disclosure relating to any product.

Vishay makes no warranty, representation or guarantee regarding the suitability of the products for any particular purpose or the continuing production of any product. To the maximum extent permitted by applicable law, Vishay disclaims (i) any and all liability arising out of the application or use of any product, (ii) any and all liability, including without limitation special, consequential or incidental damages, and (iii) any and all implied warranties, including warranties of fitness for particular purpose, non-infringement and merchantability.

Statements regarding the suitability of products for certain types of applications are based on Vishay's knowledge of typical requirements that are often placed on Vishay products in generic applications. Such statements are not binding statements about the suitability of products for a particular application. It is the customer's responsibility to validate that a particular product with the properties described in the product specification is suitable for use in a particular application. Parameters provided in datasheets and / or specifications may vary in different applications and performance may vary over time. All operating parameters, including typical parameters, must be validated for each customer application by the customer's technical experts. Product specifications do not expand or otherwise modify Vishay's terms and conditions of purchase, including but not limited to the warranty expressed therein.

Hyperlinks included in this datasheet may direct users to third-party websites. These links are provided as a convenience and for informational purposes only. Inclusion of these hyperlinks does not constitute an endorsement or an approval by Vishay of any of the products, services or opinions of the corporation, organization or individual associated with the third-party website. Vishay disclaims any and all liability and bears no responsibility for the accuracy, legality or content of the third-party website or for that of subsequent links.

Except as expressly indicated in writing, Vishay products are not designed for use in medical, life-saving, or life-sustaining applications or for any other application in which the failure of the Vishay product could result in personal injury or death. Customers using or selling Vishay products not expressly indicated for use in such applications do so at their own risk. Please contact authorized Vishay personnel to obtain written terms and conditions regarding products designed for such applications.

No license, express or implied, by estoppel or otherwise, to any intellectual property rights is granted by this document or by any conduct of Vishay. Product names and markings noted herein may be trademarks of their respective owners.