

LBTP180Y3T1G

S-LBTP180Y3T1G

PNP medium power transistors

1. FEATURES

- High current
- Low voltage
- We declare that the material of product compliance with RoHS requirements and Halogen Free.
- S- prefix for automotive and other applications requiring unique site and control change requirements; AEC-Q101 qualified and PPAP capable.

2. APPLICATIONS

- Medium power general purposes.
- Driver stages of audio amplifiers.

3. DEVICE MARKING AND ORDERING INFORMATION

Device	Marking	Shipping
LBTP180Y3T1G	E	1000/Tape&Reel

4. MAXIMUM RATINGS(Ta = 25°C)

Parameter	Symbol	Limits	Unit
Collector–Emitter Voltage	VCEO	-80	V
Collector–Base Voltage	VCBO	-100	V
Emitter–Base Voltage	VEBO	-5	V
Collector Current(DC)	IC	-1	A
Peak collector current	ICM	-1.5	A
Peak base current	IBM	-200	mA

5. THERMAL CHARACTERISTICS

Parameter	Symbol	Limits	Unit
Total Device Dissipation, FR-4 Board (Note 1) @ TA = 25°C Derate above 25°C	PD	550 4.4	mW mW/°C
Thermal Resistance, Junction–to–Ambient	RθJA	225	°C/W
Junction–to–Case	RθJC	50	°C/W
Junction and Storage temperature	TJ, Tstg	-65~+150	°C

1. PCB Size:30.0mm×25.0mm×1.6mm,FR-4 Board;

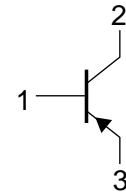
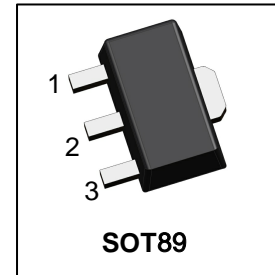

6. ELECTRICAL CHARACTERISTICS (Ta= 25°C)

Characteristic	Symbol	Min.	Typ.	Max.	Unit
Collector–Emitter Breakdown Voltage (IC = -1 mA, IB = 0)	VBR(CEO)	-80	-	-	V
Collector–Base Breakdown Voltage (IC = -100 μA, IE = 0)	VBR(CBO)	-100	-	-	V
Emitter–Base Breakdown Voltage (IE = -100 μA, IC = 0)	VBR(EBO)	-5	-	-	V
Collector Cutoff Current (VCB = -30 V, IE = 0) (VCB = -30 V, IE = 0, Tj = 125 °C)	ICBO	-	-	-100 -10	nA μA
Emitter Cut-off Current (VEB = -5V, IC = 0)	IEBO	-	-	-100	nA
Collector-Emitter cutoff Current (VCE = -80V, IB = 0)	ICEO	-	-	-10	μA
DC Current Gain (VCE = -2V, IC = -5mA) (VCE = -2V, IC = -150mA) (VCE = -2V, IC = -500mA)	HFE	40 100 45	- - -	- 250 -	
Collector–Emitter Saturation Voltage (IC = -500 mA, IB = -50 mA)	VCE(sat)	-	-	-500	mV
Base-emitter voltage (IC = -500 mA, VCE = -2 V)	VBE	-	-	-1	V
Transition Frequency (IC = -10 mA, VCE = -5 V, f = 100 MHz)	fT	-	50	-	MHz

7.ELECTRICAL CHARACTERISTICS CURVES

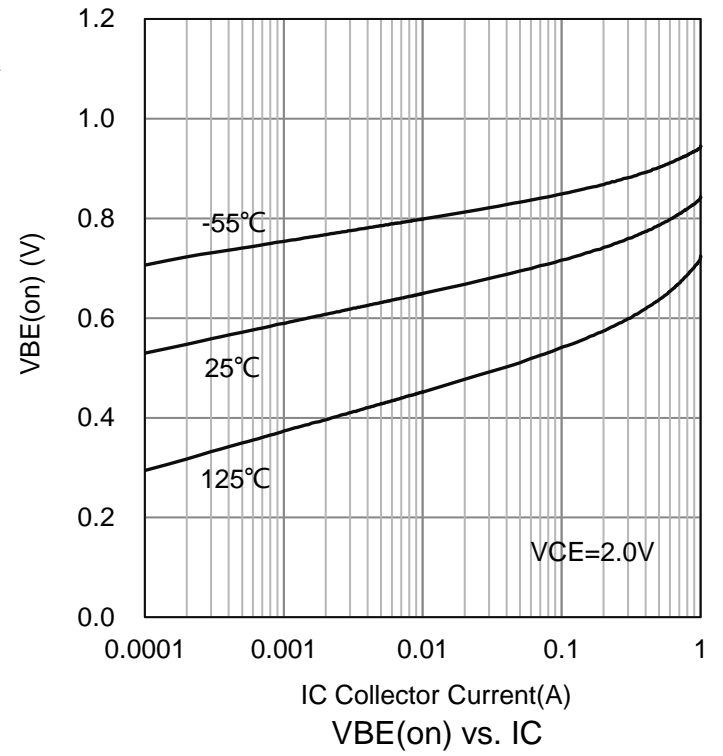
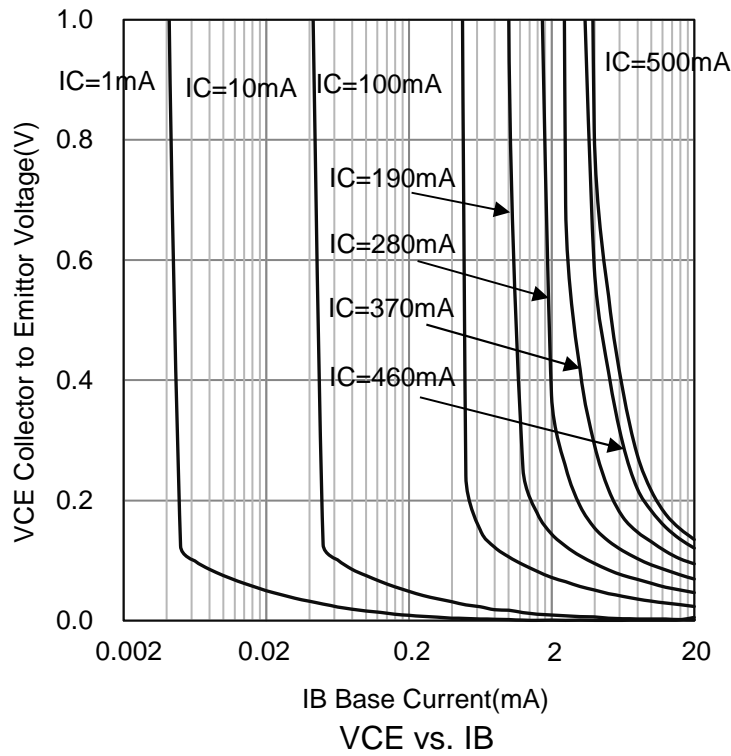
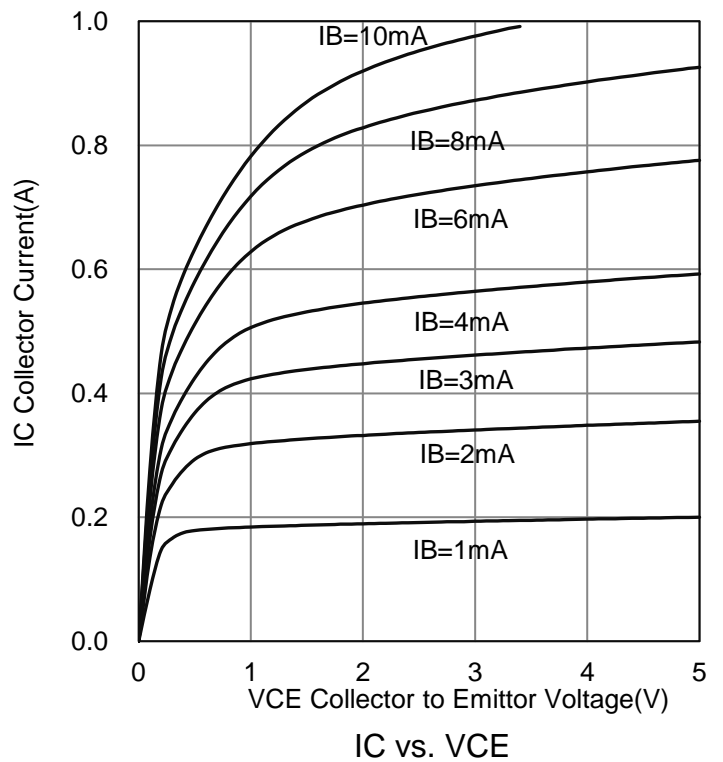
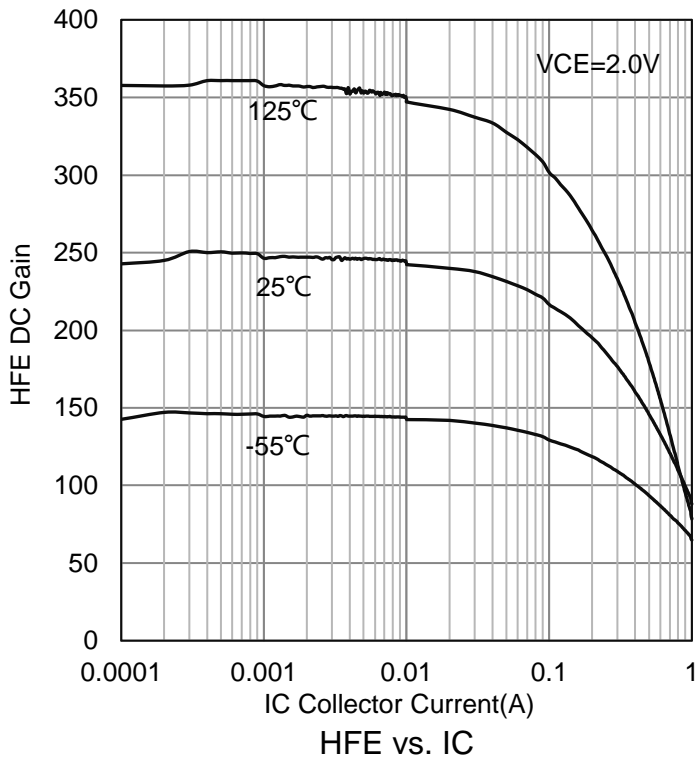

7.ELECTRICAL CHARACTERISTICS CURVES(Con.)

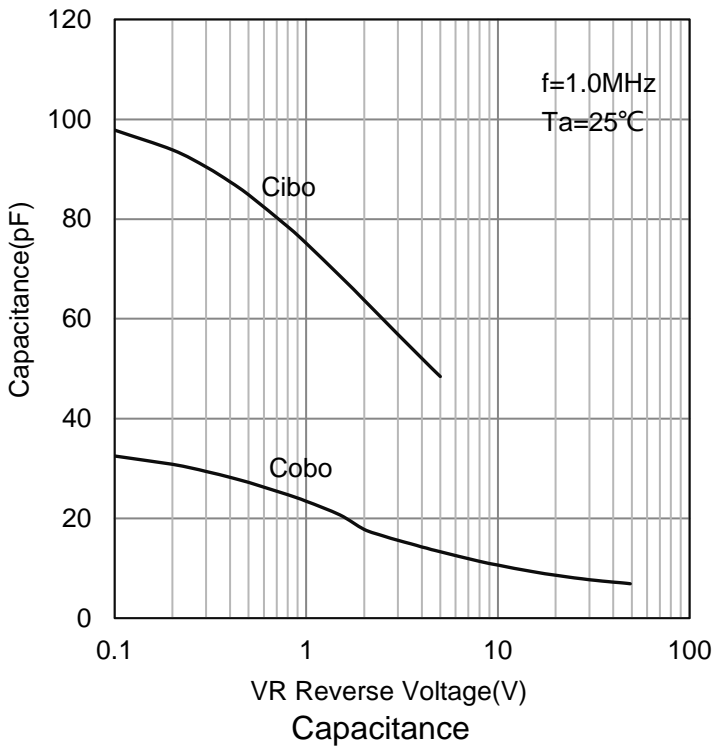
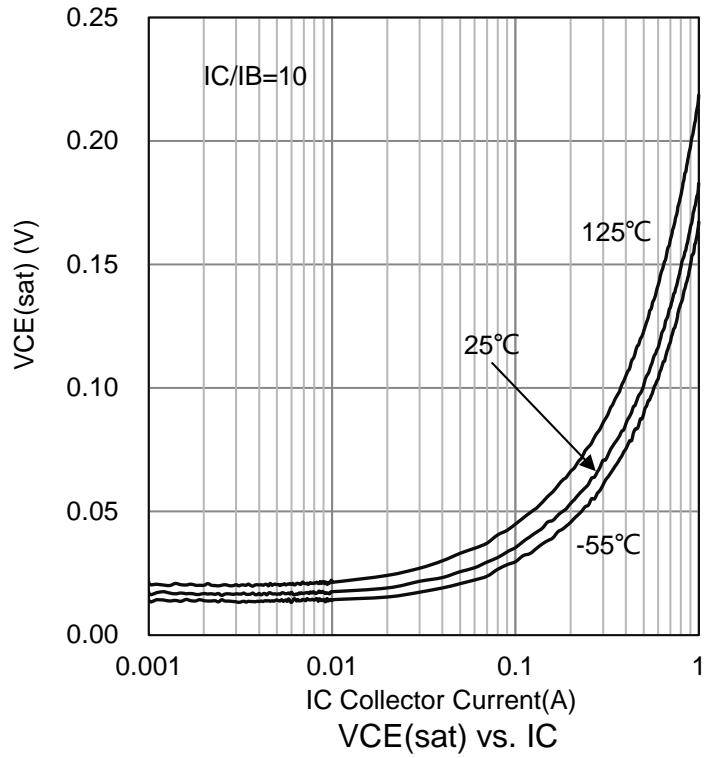
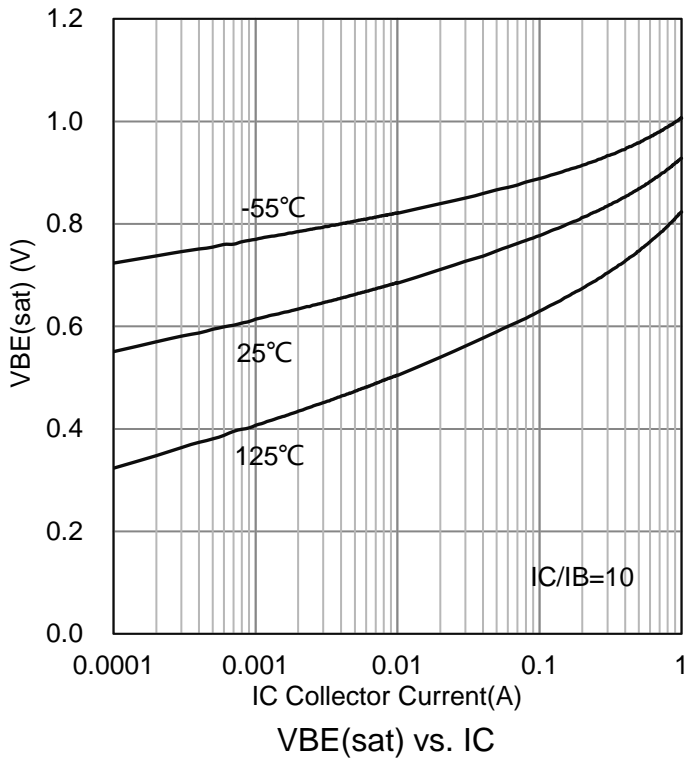

8.OUTLINE AND DIMENSIONS

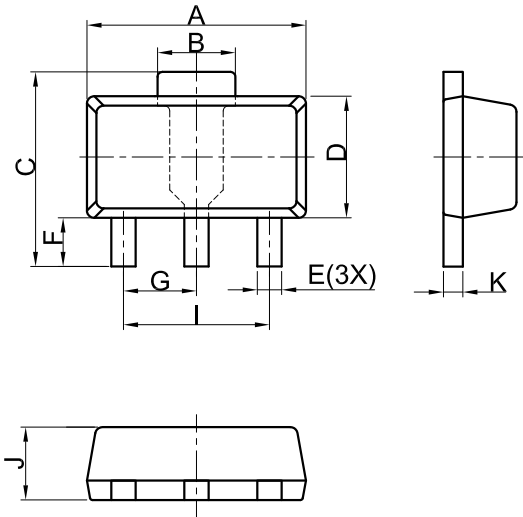

SOT89			
DIM	MIN	NOR	MAX
A	4.30	4.50	4.70
B	1.40	1.60	1.80
C	3.90	4.00	4.25
D	2.30	2.50	2.70
E	0.40	0.50	0.58
F	0.90	1.00	1.20
G	1.50 BSC		
I	3.00 BSC		
J	1.40	1.50	1.60
K	0.34	0.40	0.50
All Dimensions in mm			

GENERAL NOTES

1. Top package surface finish Ra0.4±0.2um
2. Bottom package surface finish Ra0.7±0.2um
3. Side package surface finish Ra0.4±0.2um
4. Protrusion or Gate Burrs shall not exceed 0.10mm per side.

9.SOLDERING FOOTPRINT

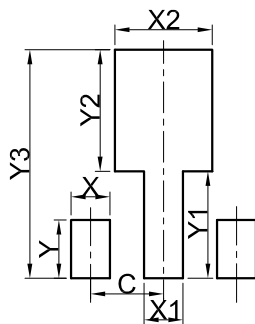

SOT89	
DIM	(mm)
X	0.80
Y	1.20
X1	0.80
Y1	2.20
X2	2.00
Y2	2.50
C	1.50
Y3	4.70

DISCLAIMER

- Before you use our Products, you are requested to carefully read this document and fully understand its contents. LRC shall not be in any way responsible or liable for failure, malfunction or accident arising from the use of any LRC's Products against warning, caution or note contained in this document.
- All information contained in this document is current as of the issuing date and subject to change without any prior notice. Before purchasing or using LRC's Products, please confirm the latest information with a LRC sales representative.