

KYL3400

30V N-Channel Mosfet

FEATURES

- $R_{DS(ON)} \leq 26m\Omega$ (19m Ω Typ.)
@ $V_{GS}=10V$
- $R_{DS(ON)} \leq 32m\Omega$ (23m Ω Typ.)
@ $V_{GS}=4.5V$
- $R_{DS(ON)} \leq 50m\Omega$ (30m Ω Typ.)
@ $V_{GS}=2.5V$

SOT-23-3L

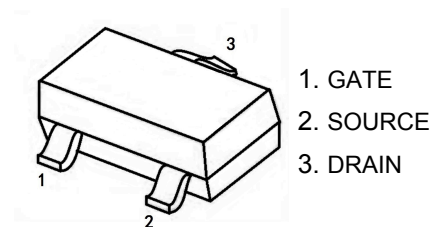

APPLICATIONS

- Load Switch
- PWM Application
- Power management

MARKING

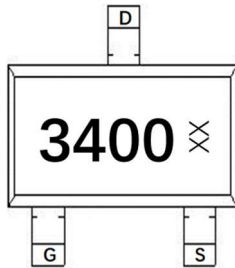

3400:Device Code

N-CHANNEL MOSFET

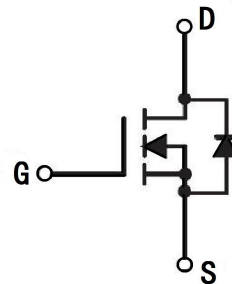

MAXIMUM RATINGS (Ta=25°C unless otherwise noted)

Symbol	Parameter	Max.	Units
V_{DSS}	Drain-Source Voltage	30	V
V_{GSS}	Gate-Source Voltage	± 12	V
I_D	Continuous Drain Current	$T_a = 25^\circ C$	5.8
		$T_a = 100^\circ C$	3.8
I_{DM}	Pulsed Drain Current note1	23.2	A
P_D	Power Dissipation	1.36	W
$R_{\theta JA}$	Thermal Resistance, Junction to Ambient	92	$^\circ C/W$
T_J, T_{STG}	Operating and Storage Temperature Range	-55 ~ +150	$^\circ C$

MOSFET ELECTRICAL CHARACTERISTICS Ta=25 °C unless otherwise specified

Symbol	Parameter	Test Condition	Min.	Typ.	Max.	Units
Off Characteristic						
$V_{(BR)DSS}$	Drain-Source Breakdown Voltage	$V_{GS}=0V, I_D=250\mu A$	30	-	-	V
I_{DSS}	Zero Gate Voltage Drain Current	$V_{DS}=30V, V_{GS}=0V,$	-	-	1.0	μA
I_{GSS}	Gate to Body Leakage Current	$V_{DS}=0V, V_{GS}= \pm 12V$	-	-	± 100	nA
On Characteristics						
$V_{GS(th)}$	Gate Threshold Voltage	$V_{DS}=V_{GS}, I_D=250\mu A$	0.5	0.9	1.4	V
$R_{DS(on)}$	Static Drain-Source on-Resistance <small>note2</small>	$V_{GS}=10V, I_D=4.2A$	-	19	26	m Ω
		$V_{GS}=4.5V, I_D=4A$	-	23	32	
		$V_{GS}=2.5V, I_D=1A$	-	30	50	
Dynamic Characteristics						
C_{iss}	Input Capacitance	$V_{DS}=15V, V_{GS}=0V,$ $f=1.0MHz$	-	535	-	pF
C_{oss}	Output Capacitance		-	130	-	pF
C_{riss}	Reverse Transfer Capacitance		-	36	-	pF
Q_g	Total Gate Charge	$V_{DS}=15V, I=4.2A,$ $V_{GS}=4.5V$	-	4.8	-	nC
Q_{gs}	Gate-Source Charge		-	1.2	-	nC
Q_{gd}	Gate-Drain("Miller") Charge		-	1.7	-	nC
Switching Characteristics						
$t_{d(on)}$	Turn-on Delay Time	$V_{DS}=15V,$ $I_D=4A, R_{GEN}=3\Omega,$ $V_{GS}=4.5V$	-	12	-	ns
t_r	Turn-on Rise Time		-	52	-	ns
$t_{d(off)}$	Turn-off Delay Time		-	17	-	ns
t_f	Turn-off Fall Time		-	10	-	ns
Drain-Source Diode Characteristics and Maximum Ratings						
I_S	Maximum Continuous Drain to Source Diode Forward Current		-	-	5.8	A
I_{SM}	Maximum Pulsed Drain to Source Diode Forward Current		-	-	23.2	A
V_{SD}	Drain to Source Diode Forward Voltage	$V_{GS}=0V, I_S=5.8A$	-	-	1.2	V

Notes:1. Repetitive Rating: Pulse Width Limited by Maximum Junction Temperature

 2. Pulse Test: Pulse Width $\leq 300\mu s$, Duty Cycle $\leq 0.5\%$

TYPICAL PERFORMANCE CHARACTERISTICS

Figure 1: Output Characteristics

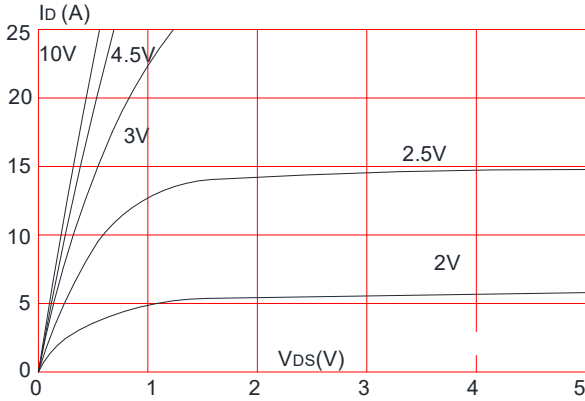

Figure 2: Typical Transfer Characteristics

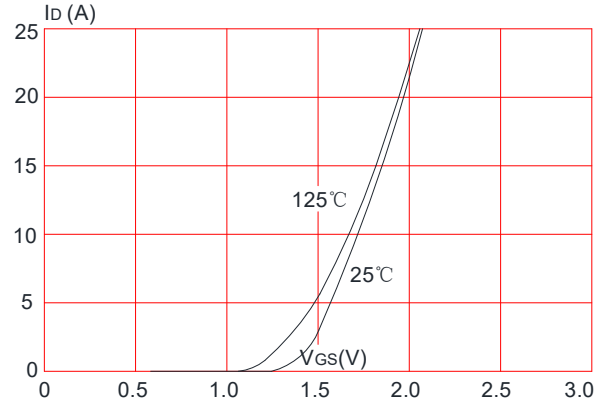

Figure 3: On-resistance vs. Drain Current

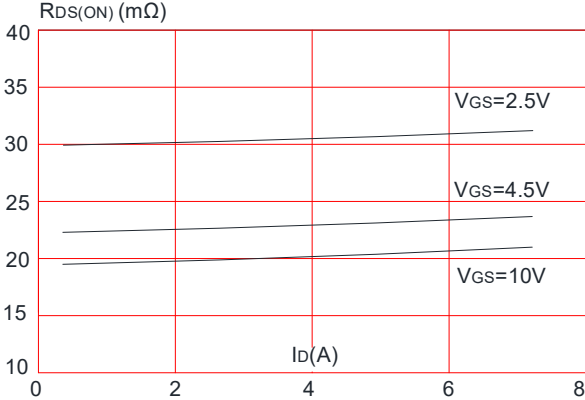

Figure 4: Body Diode Characteristics

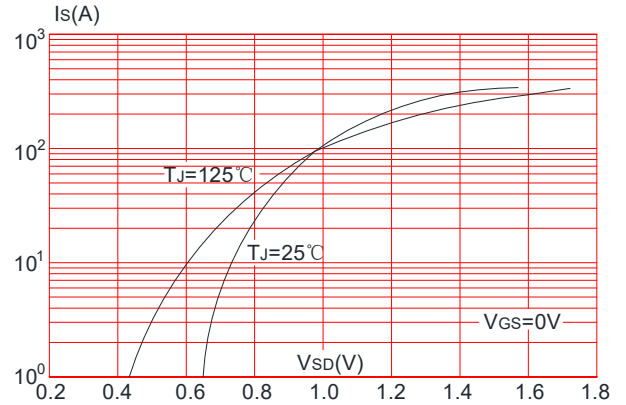

Figure 5: Gate Charge Characteristics

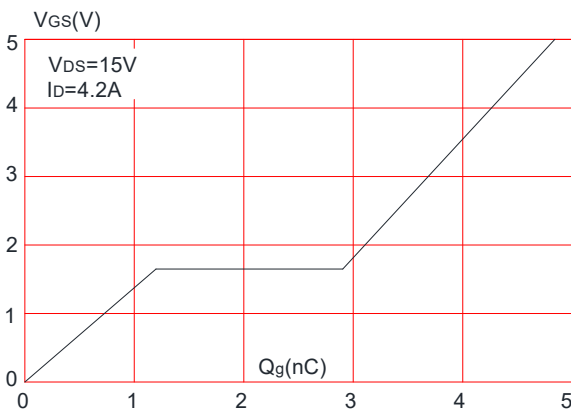
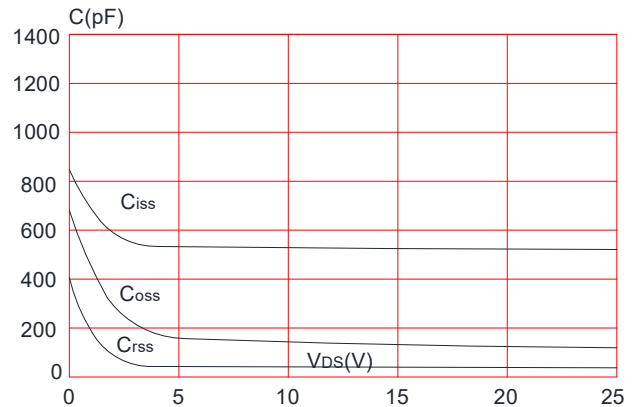

Figure 6: Capacitance Characteristics



TYPICAL PERFORMANCE CHARACTERISTICS (cont.)

Figure 7: Normalized Breakdown Voltage vs. Junction Temperature

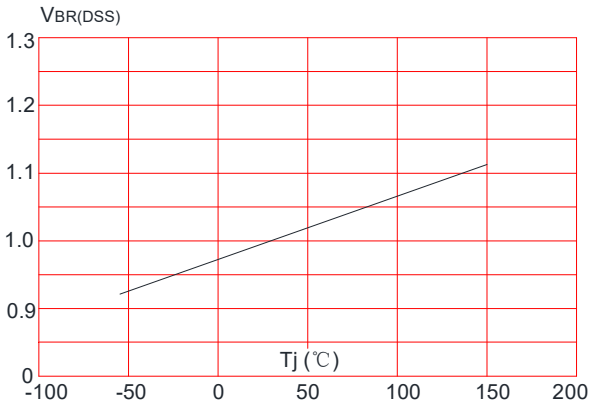

Figure 8: Normalized on Resistance vs. Junction Temperature

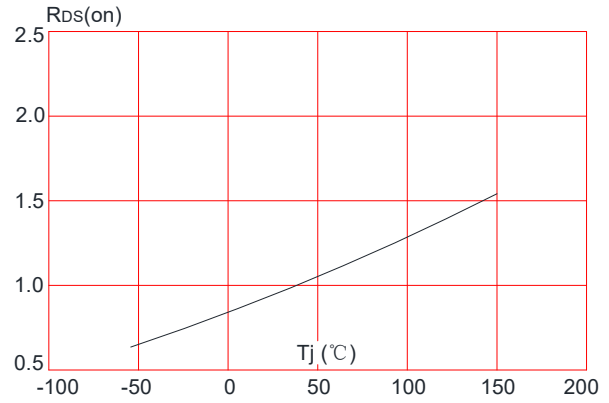

Figure 9: Maximum Safe Operating Area

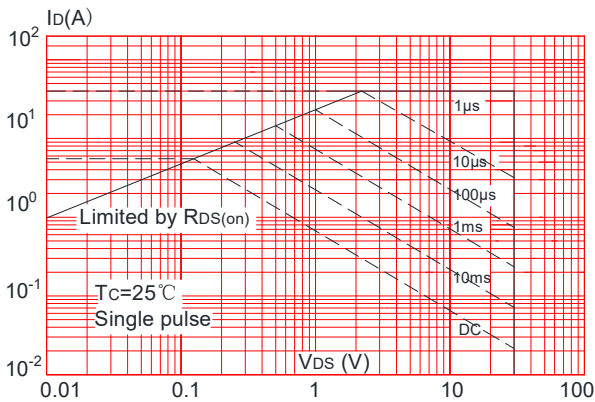

Figure 10: Maximum Continuous Drain Current vs. Case Temperature

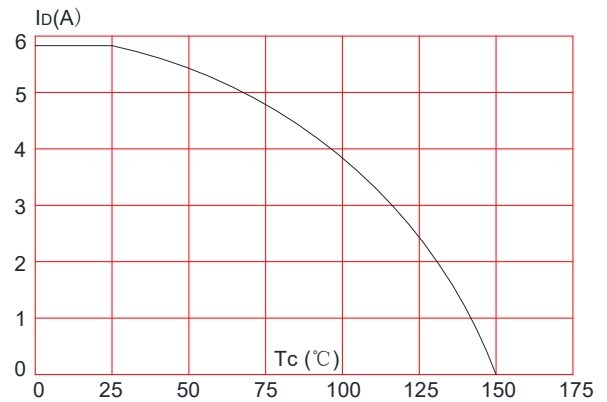
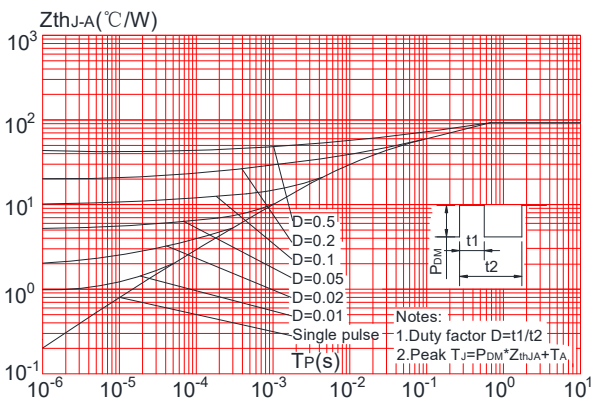
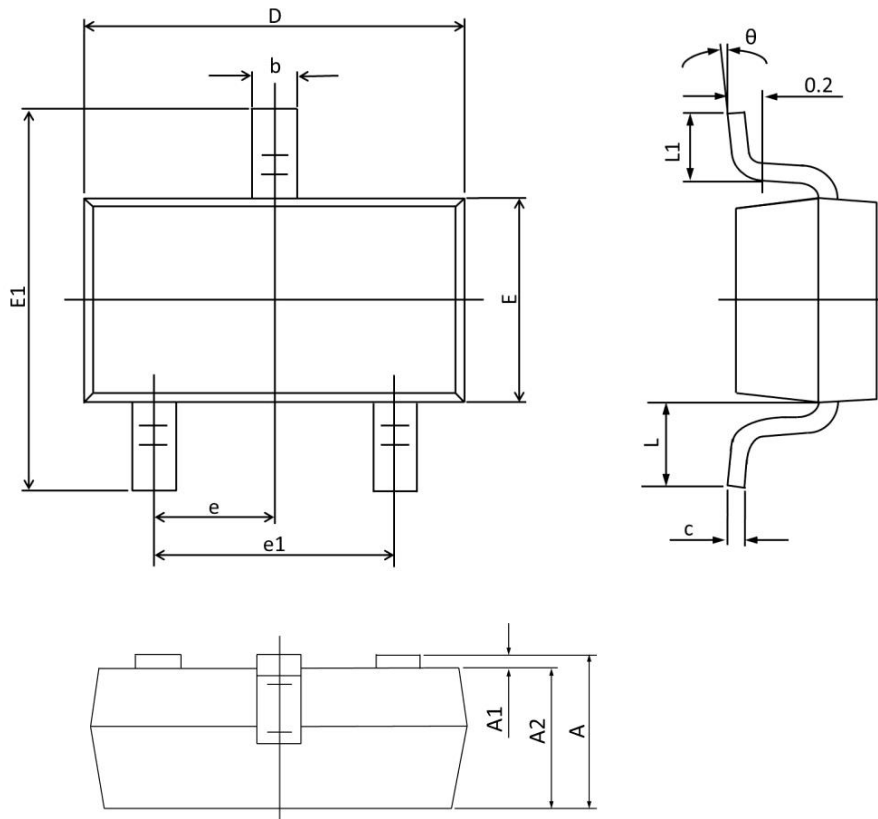

Figure.11: Maximum Effective Transient Thermal Impedance, Junction-to-Ambient



SOT-23-3L PACKAGE OUTLINE DRAWING

Symbol	Dimensions In Millimeters		Dimensions In Inches	
	Min	Max	Min	Max
A	1.050	1.250	0.041	0.049
A1	0.000	0.100	0.000	0.004
A2	1.050	1.150	0.041	0.045
b	0.300	0.400	0.012	0.016
c	0.100	0.200	0.004	0.008
D	2.820	3.020	0.111	0.119
E	1.500	1.700	0.059	0.067
E1	2.650	2.950	0.104	0.116
e	0.950 TYP.		0.037 TYP.	
e1	1.800	2.000	0.071	0.079
L	0.700 REF.		0.028 REF.	
L1	0.300	0.600	0.012	0.024
θ	0°	8°	0°	8°