

KY3400

30V N-Channel Mosfet

FEATURES

- $R_{DS(ON)} \leq 33m\Omega$ (21m Ω Typ.)
@ $V_{GS}=10V$
- $R_{DS(ON)} \leq 39m\Omega$ (25m Ω Typ.)
@ $V_{GS}=4.5V$
- $R_{DS(ON)} \leq 60m\Omega$ (36m Ω Typ.)
@ $V_{GS}=2.5V$

APPLICATIONS

- Load/Power Switching
- Interfacing Switching

MARKING

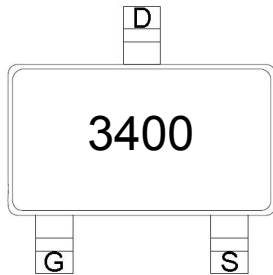

Other mark: "R0"

SOT-23

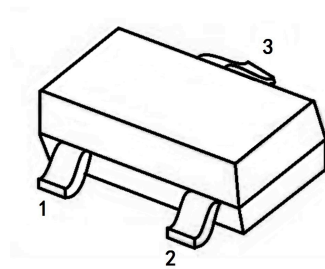

1. GATE
2. SOURCE
3. DRAIN

N-CHANNEL MOSFET

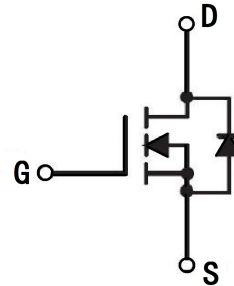

MAXIMUM RATINGS (Ta=25°C unless otherwise noted)

Symbol	Parameter	Max.	Units
V_{DSS}	Drain-Source Voltage	30	V
V_{GSS}	Gate-Source Voltage	± 12	V
I_D	Continuous Drain Current	5.8	A
I_{DM}	Pulsed Drain Current ^{note1}	30	A
P_D	Power Dissipation	0.35	W
$R_{\theta JA}$	Thermal Resistance, Junction to Ambient	357	$^{\circ}C/W$
T_J	Operating and Storage Temperature Range	150	$^{\circ}C$
T_{STG}	Operating and Storage Temperature Range	-55 to +150	$^{\circ}C$

MOSFET ELECTRICAL CHARACTERISTICS Ta=25 °C unless otherwise specified

Symbol	Parameter	Test Condition	Min.	Typ.	Max.	Units
Off Characteristic						
$V_{(BR)DSS}$	Drain-Source Breakdown Voltage	$V_{GS} = 0V, I_D = 250\mu A$	30	31.5	-	V
I_{DSS}	Zero Gate Voltage Drain Current	$V_{DS} = 30V,$ $V_{GS} = 0V, T_J = 25^\circ C$	-	-	1	μA
I_{GSS}	Gate to Body Leakage Current	$V_{GS} = \pm 12V, V_{DS} = 0V$	-	-	± 100	nA
On Characteristics						
$V_{GS(th)}$	Gate Threshold Voltage	$V_{DS} = V_{GS}, I_D = 250\mu A$	0.7	1	1.4	V
$R_{DS(on)}$	Static Drain-Source On-Resistance <small>note2</small>	$V_{GS} = 10V, I_D = 5A$	-	21	33	m Ω
		$V_{GS} = 4.5V, I_D = 4A$	-	25	39	
		$V_{GS} = 2.5V, I_D = 3A$	-	36	60	
Dynamic Characteristics						
C_{iss}	Input Capacitance	$V_{DS} = 15V, V_{GS} = 0V,$ $f = 1.0MHz$	-	-	1155	pF
C_{oss}	Output Capacitance		-	108	-	pF
C_{rss}	Reverse Transfer Capacitance		-	84	-	pF
Q_g	Total Gate Charge	$V_{DS} = 15V, I_D = 5.8A,$ $V_{GS} = 4.5V, f = 1.0MHz$	-	10	-	nC
Q_{gs}	Gate-Source Charge		-	1.6	-	nC
Q_{gd}	Gate-Drain("Miller") Charge		-	3.1	-	nC
Switching Characteristics						
$t_{d(on)}$	Turn-On Delay Time	$V_{GS} = 10V, V_{DS} = 15V,$ $R_L = 2.7\Omega, R_{GEN} = 3\Omega$	-	-	5	ns
t_r	Turn-On Rise Time		-	-	7	ns
$t_{d(off)}$	Turn-Off Delay Time		-	-	40	ns
t_f	Turn-Off Fall Time		-	-	6	ns
Drain-Source Diode Characteristics and Maximum Ratings						
V_{SD}	Drain to Source Diode Forward Voltage	$V_{GS} = 0V, I_{SD} = 1A,$ $T_J = 25^\circ C$	-	0.8	1	V

Notes: 1. Pulse Test : Pulse Width < 300 μs , Duty Cycle $\leq 2\%$.

2. Guaranteed by design, not subject to production testing.

TYPICAL PERFORMANCE CHARACTERISTICS

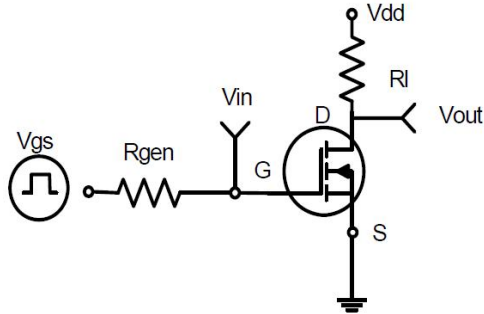

Figure 1: Switching Test Circuit

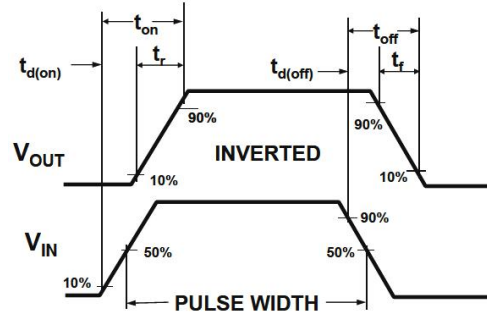

Figure 2: Switching Waveforms

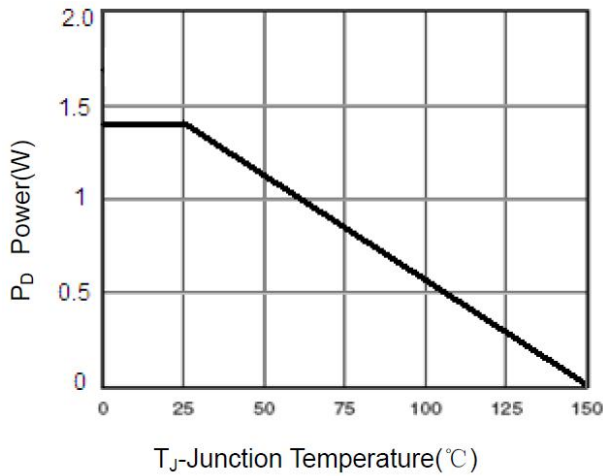

Figure 3 Power Dissipation

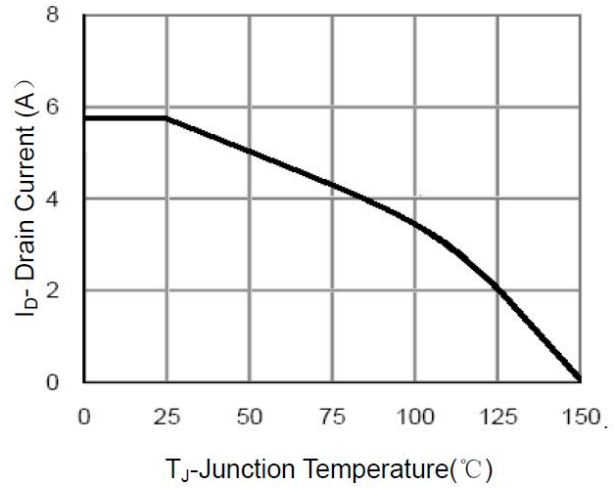

Figure 4 Drain Current

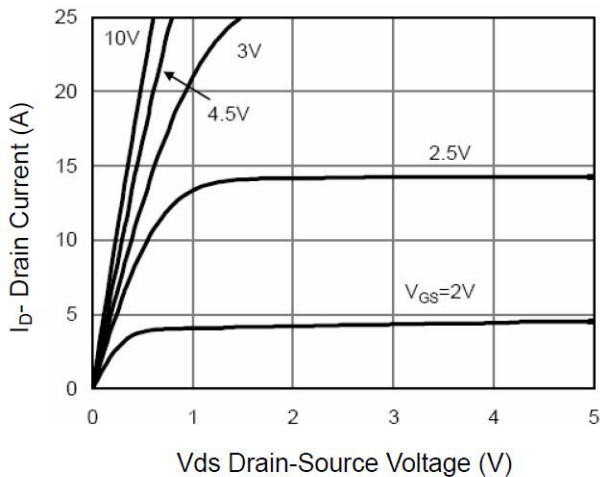

Figure 5 Output Characteristics

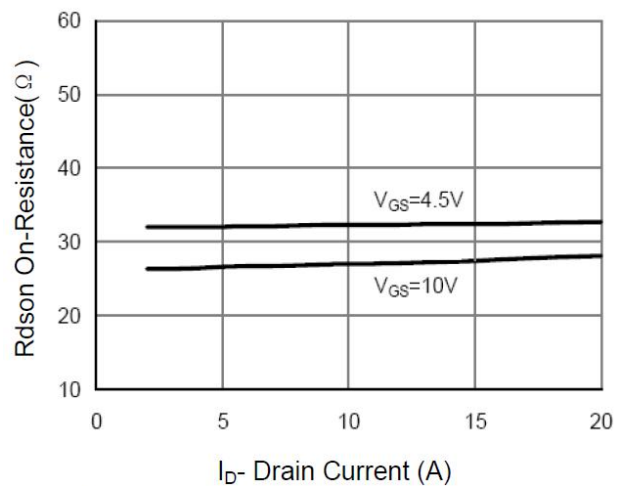

Figure 6 Drain-Source On-Resistance

TYPICAL PERFORMANCE CHARACTERISTICS (cont.)

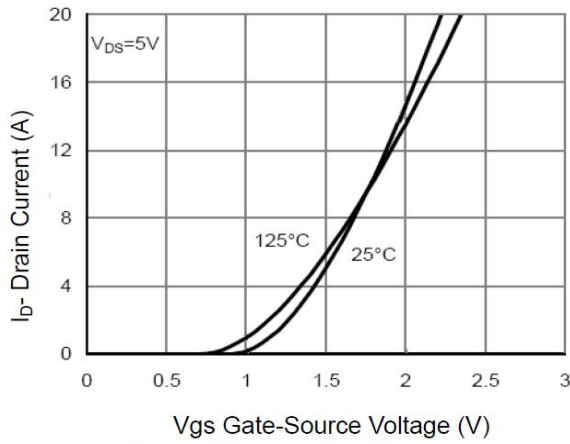

Figure 7 Transfer Characteristics

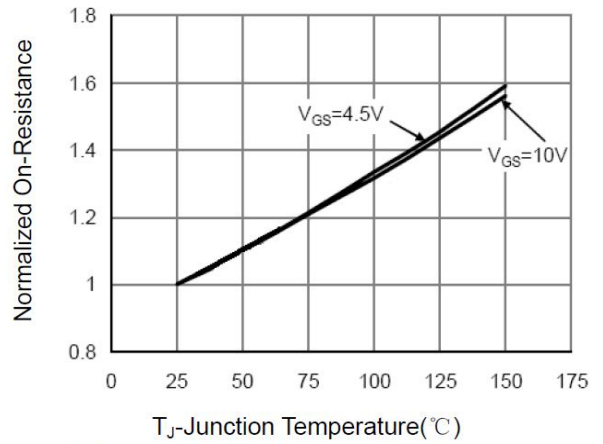

Figure 8 Drain-Source On-Resistance

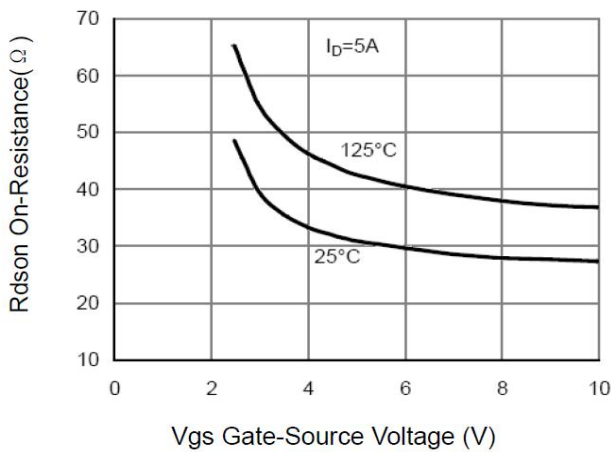

Figure 9 Rdson vs Vgs

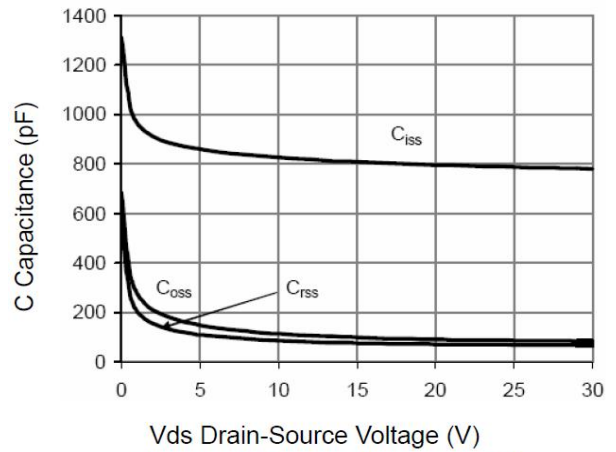

Figure 10 Capacitance vs Vds

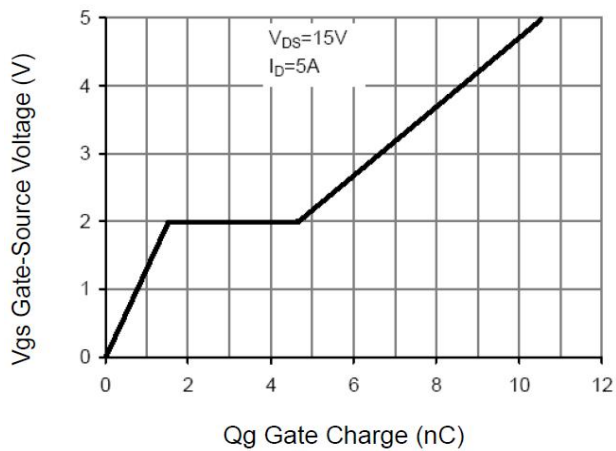

Figure 11 Gate Charge

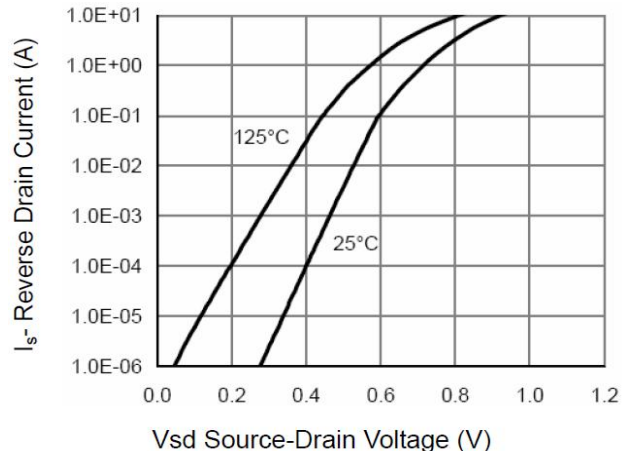
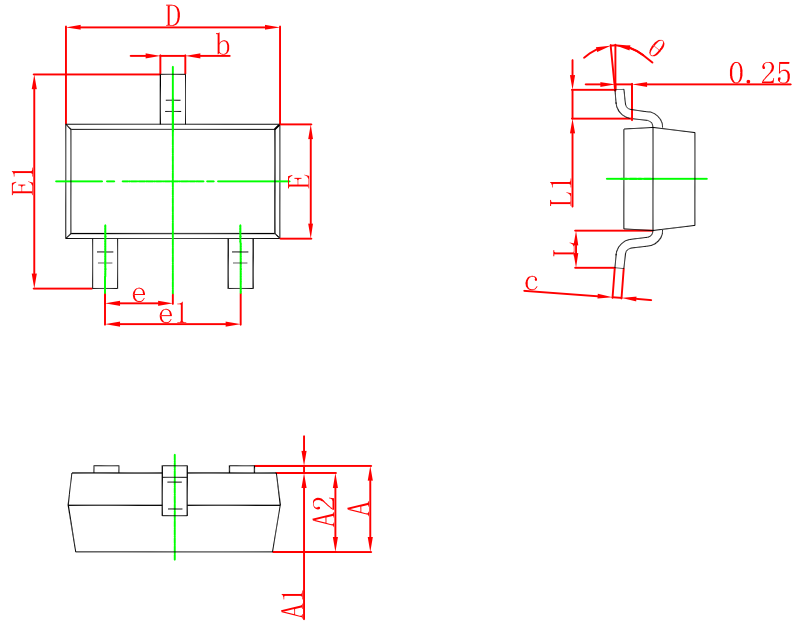

Figure 12 Source- Drain Diode Forward

SOT-23 PACKAGE OUTLINE DRAWING



Symbol	Dimensions In Millimeters		Dimensions In Inches	
	Min	Max	Min	Max
A	0.900	1.150	0.035	0.045
A1	0.000	0.100	0.000	0.004
A2	0.900	1.050	0.035	0.041
b	0.300	0.500	0.012	0.020
c	0.080	0.150	0.003	0.006
D	2.800	3.000	0.110	0.118
E	1.200	1.400	0.047	0.055
E1	2.250	2.550	0.089	0.100
e	0.950 TYP		0.037 TYP	
e1	1.800	2.000	0.071	0.079
L	0.550 REF		0.022 REF	
L1	0.300	0.500	0.012	0.020
θ	0°	8°	0°	8°