

MATED CONDITION(REF.)

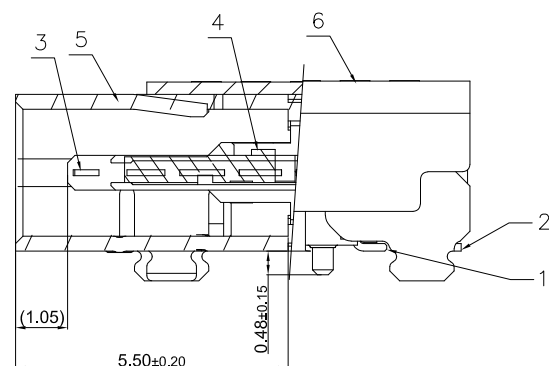

SECTION A-A(剖视图A-A)  
SCALE 2:1 (比例 2:1)

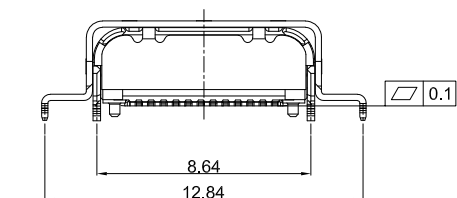
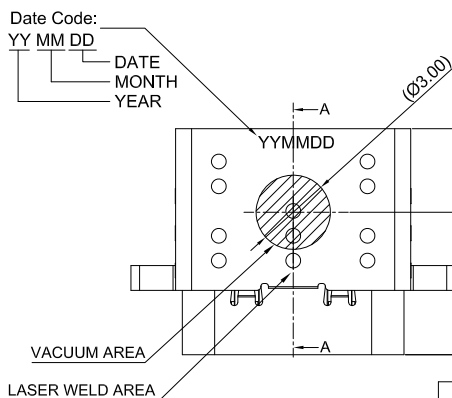
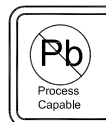

Unless otherwise specified, Tolerance:  
X. ±0.30  
X.x ±0.20  
X.xx ±0.15  
X.xxx ±0.10  
Angles ±3°



NOTES

1. GENERAL SPECIFICATION:

- 1.1 COPLANARITY: 0.10 Max.
- 1.2 CURRENT RATING: 5A
- 1.3 CONTACT RESISTANCE: 40mΩ MAX (INITIAL).  
INSULATION RESISTANCE:100MΩ Min
- 1.4 DIELECTRIC WITHSTANDING VOLTAGE: 100 VAC
- 1.5 MECHANICAL CHARACTERISTICS:  
INSERTION FORCE: 5~20N EXTRACTION FORCE: 8~20N  
AFTER DURABILITY EXTRACTION FORCE: 6~20N
- 1.6 Durability Cycle:10,000 cycle
- 1.7 Operating temperature: -40°C~+85°C

A1	A2	A3	A4	A5	A6	A7	A8	A9	A10	A11	A12	
GND	TX1+	TX1-	VBUS	CC1	D+	D-	SBU1	VBUS	RX2-	RX2+	GND	
GND	RX1+	RX1-	VBUS	SBU2	D-	D+	CC2	VBUS	TX2-	TX2+	GND	
B12	B11	B10	B9	B8	B7	B6	B5	B4	B3	B2	B1	
6	OUT SHELL	1	SUS304	NICKEL PLATING							0.25mm	
5	INT SHELL	1	SUS304	NICKEL PLATING							0.3mm	
4	MAIN HOUSING	1	PAST HF 30%碳纤维, UL94 V-0, 黑色	-							COLOR:BLACK	
3	MID PLATE	1	SUS301	-							0.15mm	
2	BOTTOM TERMINAL	1	C18140	-							0.12mm	
1	TOP TERMINAL	1	C18140	MATING SIDE:SEE PART NO: SOLDER TAIL:GOLD FLASH, 30μ" NICKEL OVERALL.							0.12mm	
ITEM	DESCRIPTION	QTY	MATERIAL	FINISH							REMARK	

**G-Switch Electronic (HongKong) CO.,Ltd.**

DESIGN Li Qingqi	DATE 2022.04.22	Molde code:	
CHECKED	DATE	GT-USB-7088A	
APPROVED	DATE	REV.: X1	SCALE: 4:1
http://www.dg-switch.com		UNIT: mm	
TEL:0769-82388879		SIZE: A4	SHEET: 1/1

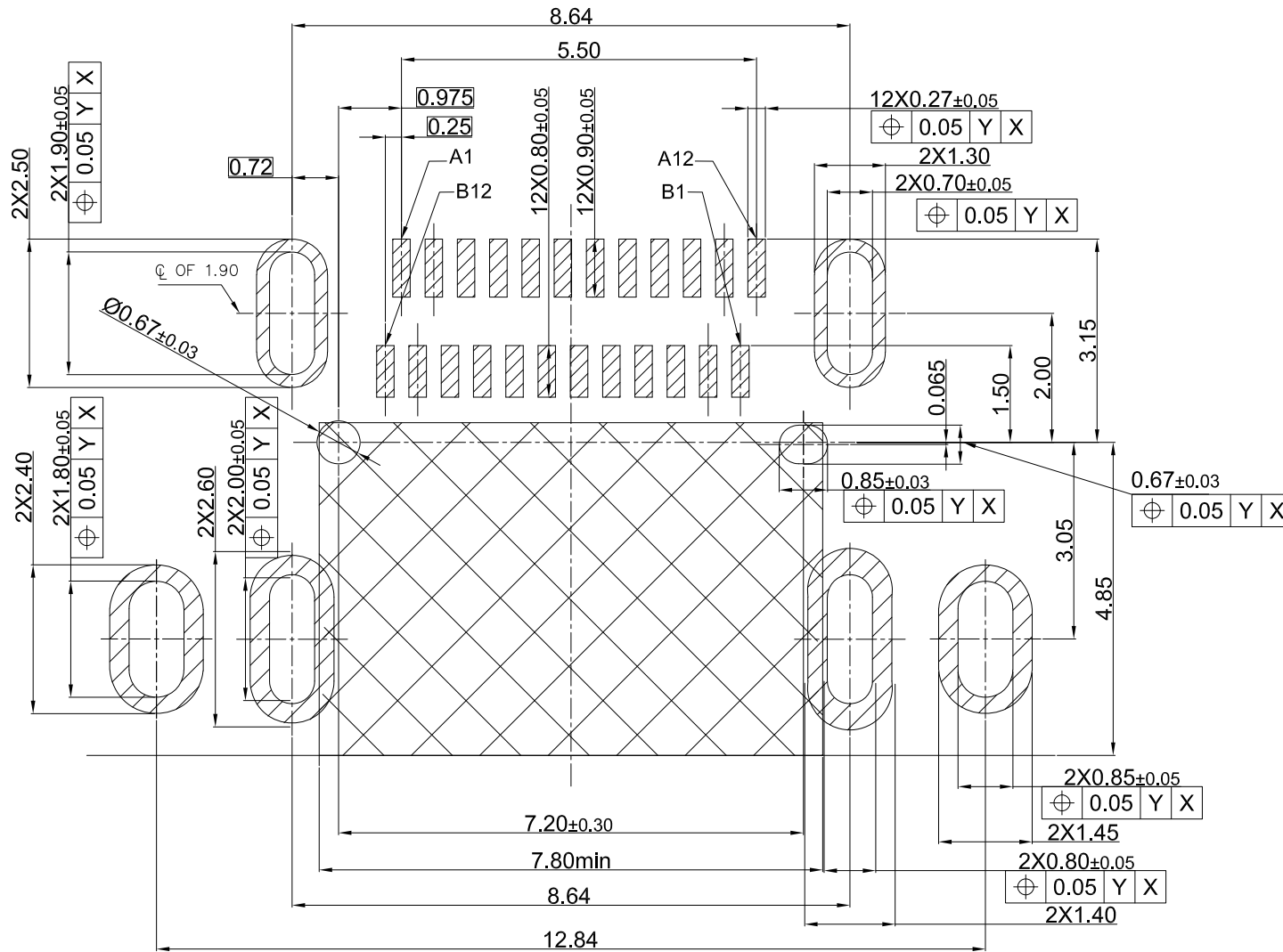

Recommended PCB Layout(Top View)/推荐的PCB布局(前视图)

General Tolerances:±0.05/一般公差:±0.05

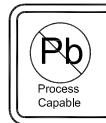

**G-Switch Electronic (HongKong) CO.,Ltd.**

Unless otherwise specified, Tolerance:  
 X. ±0.30  
 X.x ±0.20  
 X.xx ±0.15  
 X.xxx ±0.10  
 Angles ±3°

DESIGN Li Qingqi DATE 2022.04.22  
 CHECKED DATE  
 APPROVED DATE  
<http://www.dg-switch.com>  
 TEL:0769-82388879

Molde code:  
 GT-USB-7088A  
 REV.: X1 SCALE: 4:1 UNIT: mm  
 SIZE: A4 SHEET: 1/1

20PCS EMPTY      1000PCS PRODUCTS      BEGINNING PORTION 400mm MIN  
20PCS EMPTY

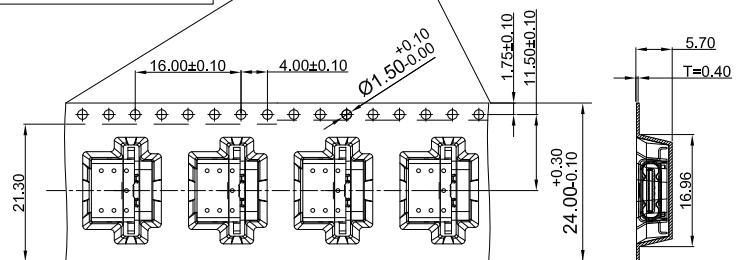

CUSTOMER UNWINDING DIRECTION

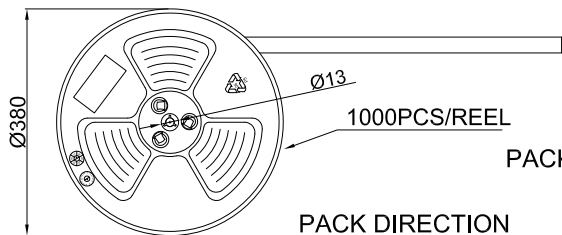

PACKING: 1. 1000 PCS/REEL.  
2. 10 REEL/Cartron

PACK DIRECTION

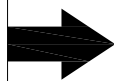

PAPER BOARD

REEL AND TAPE

REEL AND TAPE

PAPER BOARD

FOLDER  
PAPER BOARD

CARTON

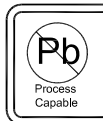

**G-Switch Electronic (HongKong) CO.,Ltd.**

Unless otherwise specified, Tolerance:  
X. ±0.30  
X.x ±0.20  
X.xx ±0.15  
X.xxx ±0.10  
Angles ±3°

DESIGN Li Qingqi	DATE 2022.04.22
CHECKED	DATE
APPROVED	DATE
<a href="http://www.dg-switch.com">http://www.dg-switch.com</a>	
TEL:0769-82388879	

Molde code:		
GT-USB-7088A		
REV.: X1	SCALE: 4:1	UNIT: mm
SIZE: A4	SHEET: 1/1	