

A B C D E F G

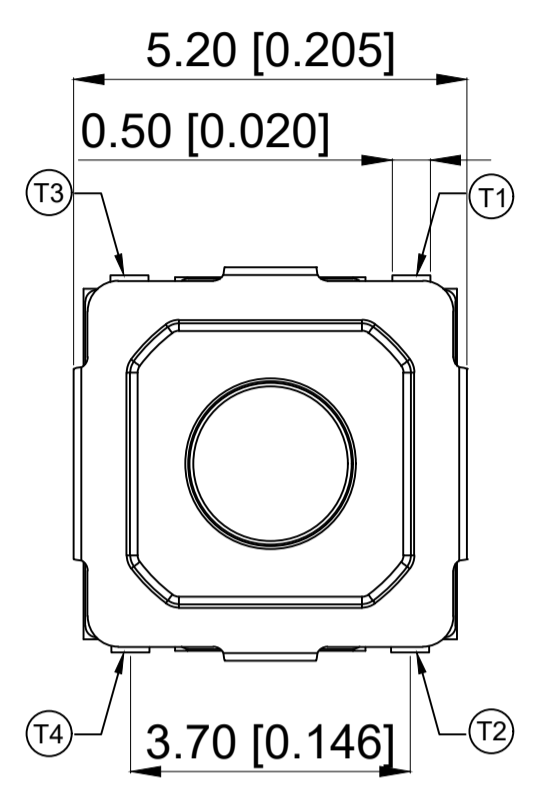

Circuit Diagram

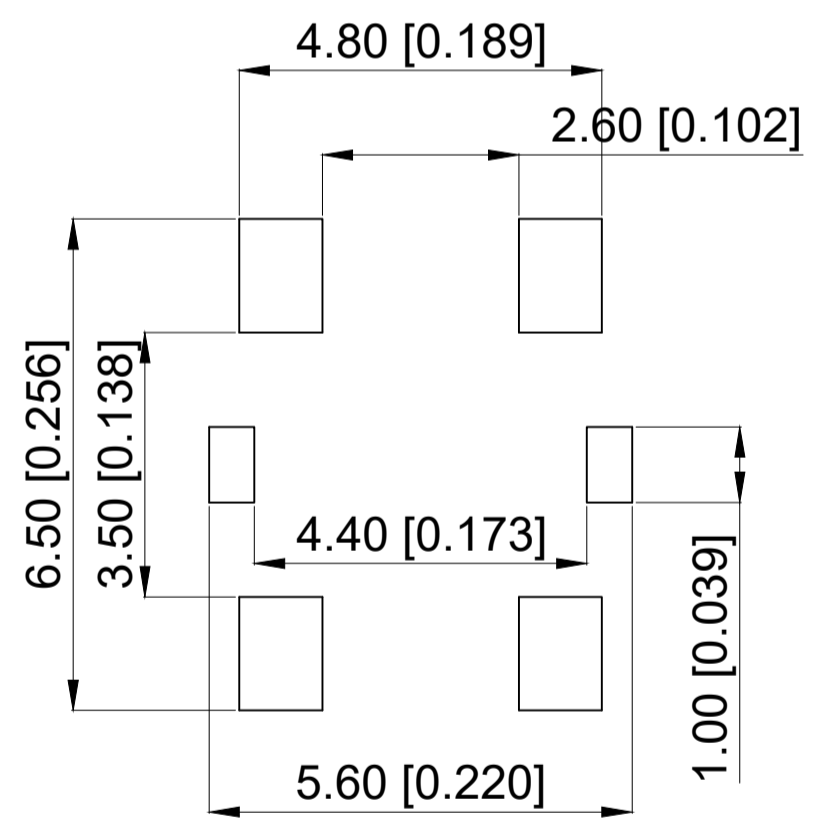
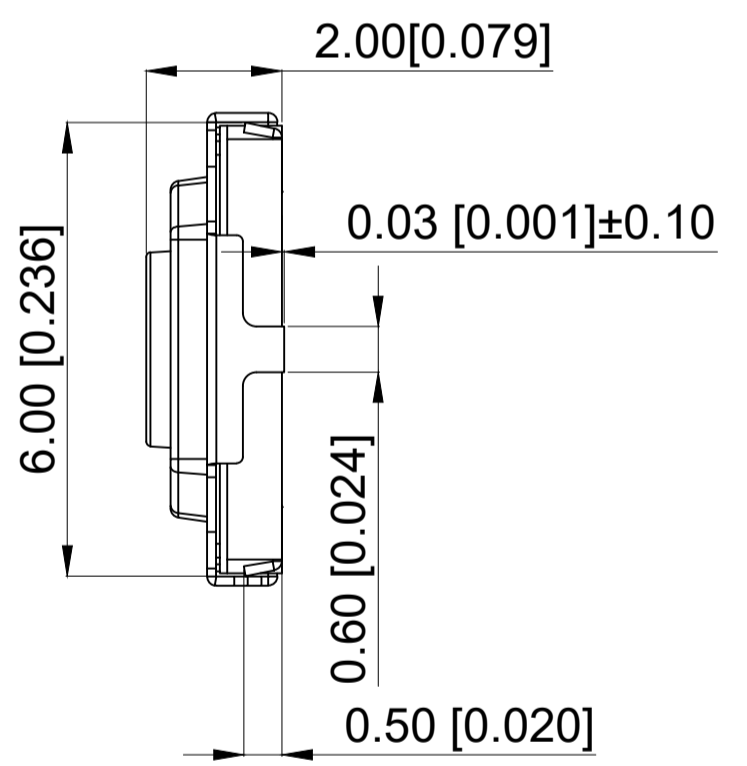
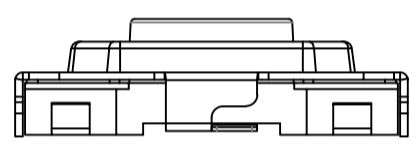
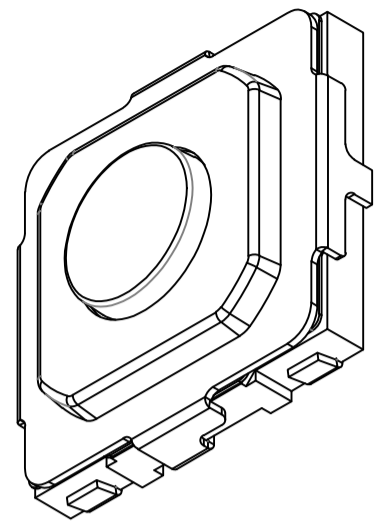
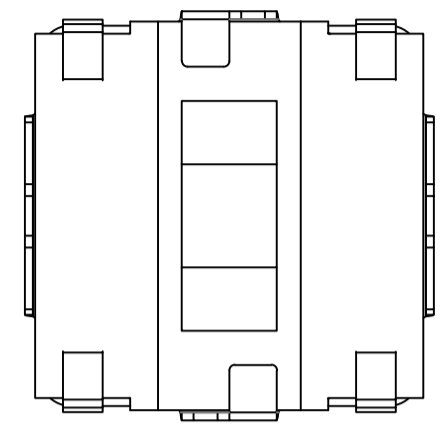
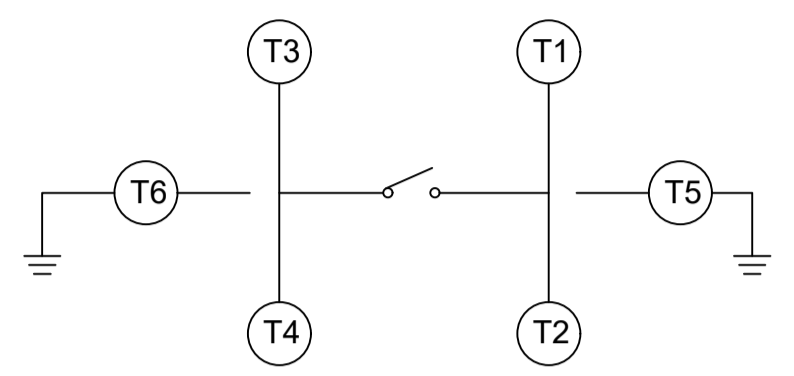

Main Specifications:

主要技术指标:
 Climate grade: -30°C~ + 80°C
 气候等级: -30°C~ + 80
 Rated values: Max50 Ma12V, DC Min10 uA1V DC
 额定值: Max50 Ma12V, DC Min10 uA1V DC
 Contact resistance: ≤100m Ω
 接触电阻: ≤100m Ω

Dielectric strength: 250V AC 1Min
 耐压: 250V AC 1Min
 Insulation resistance: ≥100MΩ
 绝缘电阻: ≥100MΩ
 Travel: 0.20±0.10mm
 行程: 0.20±0.10mm
 Operating force: 260±50gf
 操作力: 260±50gf
 Life: 200000
 寿命: 200000

6	Upper cover 上盖	1	SUS 不锈钢	
5	Push Button 按钮	1	LCP	Black 黑色
4	Terminal 端子	1	Phosphor bronze 磷青铜	Silver plating 镀银
3	Yellow Membrane 黄膜	1	PI	Yellow 黄色
2	Shrapnel 弹片	1	SUS 不锈钢	Silver plating 镀银
1	Plastic base 塑胶底座	1	LCP	Black 黑色
NO	Name	PCS	Materials	Notes

A4				
A3				
A2				
A1				
REV	DATE	REVISION	DESCRIPTION	ISSUE
		A		B



COMMON	TOLERANCE
X.XX	± 0.10
X.X	± 0.15
X	± 0.25
ANGULAR	—

UNIT	MM	PROJECTED		PRODUCT NAME:
DRAWN BY	FUYUAN	CHECKED BY	COCO	MODEL NO: TP10332620
DATE	2019	APPROVAL B	ALEN	Https: www.rocpcu.tw

ROCPCU TECHNOLOGY CO.,LTD

Copies are issued in strict confidence and shall not be reproduced or copied, or used as the basic of manufacture or sale of apparatus without permission

A B C D E F G