

Notice for TAIYO YUDEN products

Please read this notice before using the TAIYO YUDEN products.

⚠️ REMINDERS

■ Product Information in this Catalog

Product information in this catalog is as of January 2021. All of the contents specified herein and production status of the products listed in this catalog are subject to change without notice due to technical improvement of our products, etc. Therefore, please check for the latest information carefully before practical application or use of our products.

Please note that TAIYO YUDEN shall not be in any way responsible for any damages and defects in products or equipment incorporating our products, which are caused under the conditions other than those specified in this catalog or individual product specification sheets.

■ Approval of Product Specifications

Please contact TAIYO YUDEN for further details of product specifications as the individual product specification sheets are available. When using our products, please be sure to approve our product specifications or make a written agreement on the product specification with TAIYO YUDEN in advance.

■ Pre-Evaluation in the Actual Equipment and Conditions

Please conduct validation and verification of our products in actual conditions of mounting and operating environment before using our products.

■ Limited Application

1. Equipment Intended for Use

The products listed in this catalog are intended for general-purpose and standard use in general electronic equipment (e.g., AV equipment, OA equipment, home electric appliances, office equipment, information and communication equipment including, without limitation, mobile phone, and PC) and other equipment specified in this catalog or the individual product specification sheets.

TAIYO YUDEN has the line-up of the products intended for use in automotive electronic equipment, telecommunications infrastructure and industrial equipment, or medical devices classified as GHTF Classes A to C (Japan Classes I to III). Therefore, when using our products for these equipment, please check available applications specified in this catalog or the individual product specification sheets and use the corresponding products.

2. Equipment Requiring Inquiry

Please be sure to contact TAIYO YUDEN for further information before using the products listed in this catalog for the following equipment (excluding intended equipment as specified in this catalog or the individual product specification sheets) which may cause loss of human life, bodily injury, serious property damage and/or serious public impact due to a failure or defect of the products and/or malfunction attributed thereto.

- (1) Transportation equipment (automotive powertrain control system, train control system, and ship control system, etc.)
- (2) Traffic signal equipment
- (3) Disaster prevention equipment, crime prevention equipment
- (4) Medical devices classified as GHTF Class C (Japan Class III)
- (5) Highly public information network equipment, data-processing equipment (telephone exchange, and base station, etc.)
- (6) Any other equipment requiring high levels of quality and/or reliability equal to the equipment listed above

3. Equipment Prohibited for Use

Please do not incorporate our products into the following equipment requiring extremely high levels of safety and/or reliability.

- (1) Aerospace equipment (artificial satellite, rocket, etc.)
- (2) Aviation equipment *¹
- (3) Medical devices classified as GHTF Class D (Japan Class IV), implantable medical devices *²

- (4) Power generation control equipment (nuclear power, hydroelectric power, thermal power plant control system, etc.)
- (5) Undersea equipment (submarine repeating equipment, underwater work equipment, etc.)
- (6) Military equipment
- (7) Any other equipment requiring extremely high levels of safety and/or reliability equal to the equipment listed above

*Notes:

1. There is a possibility that our products can be used only for aviation equipment that does not directly affect the safe operation of aircraft (e.g., in-flight entertainment, cabin light, electric seat, cooking equipment) if such use meets requirements specified separately by TAIYO YUDEN. Please be sure to contact TAIYO YUDEN for further information before using our products for such aviation equipment.
2. Implantable medical devices contain not only internal unit which is implanted in a body, but also external unit which is connected to the internal unit.

4. Limitation of Liability

Please note that unless you obtain prior written consent of TAIYO YUDEN, TAIYO YUDEN shall not be in any way responsible for any damages incurred by you or third parties arising from use of the products listed in this catalog for any equipment that is not intended for use by TAIYO YUDEN, or any equipment requiring inquiry to TAIYO YUDEN or prohibited for use by TAIYO YUDEN as described above.

■ Safety Design

When using our products for high safety and/or reliability-required equipment or circuits, please fully perform safety and/or reliability evaluation. In addition, please install (i) systems equipped with a protection circuit and a protection device and/or (ii) systems equipped with a redundant circuit or other system to prevent an unsafe status in the event of a single fault for a failsafe design to ensure safety.

■ Intellectual Property Rights

Information contained in this catalog is intended to convey examples of typical performances and/or applications of our products and is not intended to make any warranty with respect to the intellectual property rights or any other related rights of TAIYO YUDEN or any third parties nor grant any license under such rights.

■ Limited Warranty

Please note that the scope of warranty for our products is limited to the delivered our products themselves and TAIYO YUDEN shall not be in any way responsible for any damages resulting from a failure or defect in our products. Notwithstanding the foregoing, if there is a written agreement (e.g., supply and purchase agreement, quality assurance agreement) signed by TAIYO YUDEN and your company, TAIYO YUDEN will warrant our products in accordance with such agreement.

■ TAIYO YUDEN's Official Sales Channel

The contents of this catalog are applicable to our products which are purchased from our sales offices or authorized distributors (hereinafter "TAIYO YUDEN's official sales channel"). Please note that the contents of this catalog are not applicable to our products purchased from any seller other than TAIYO YUDEN's official sales channel.

■ Caution for Export

Some of our products listed in this catalog may require specific procedures for export according to "U.S. Export Administration Regulations", "Foreign Exchange and Foreign Trade Control Law" of Japan, and other applicable regulations. Should you have any questions on this matter, please contact our sales staff.

▶ This catalog contains the typical specification only due to the limitation of space. When you consider the purchase of our products, please check our product specification sheets. For details of each product (characteristics graph, reliability information, precautions for use, and so on), see our website (<http://www.ty-top.com/>).

Industrial Application Guide

The products described as “For Telecommunications Infrastructure and Industrial Equipment” in this catalog are intended for use in the equipment shown in the below table as its typical example. Therefore, when using our products for these equipment, please check it carefully by referring to the part number or the individual product specification sheets and use the corresponding products. Should you have any questions on this matter, please contact us.

Category	Telecommunications Infrastructure and Industrial Equipment (Typical Example)
Telecommunications Infrastructure	<ul style="list-style-type: none"> • Base Station • Optical Transceiver • Router/Switch (Carrier-Grade) • UPS (Uninterruptible Power Supply), etc.
Factory Automation	<ul style="list-style-type: none"> • PLC (Programmable Logic Controller) • Servomotor/Servo Driver • Industry Robot, etc.
Measurement	<ul style="list-style-type: none"> • Gas Meter • Water Meter • Flow Meter • Pressure Gauge Meter • Magnetometer • Thermometer, etc.
Electric Power Apparatus	<ul style="list-style-type: none"> • Power Conditioner (Solar Power System) • Smart Meter • GFCI (Ground Fault Circuit Interrupter) • Electric Vehicle Charging Station, etc.

Part Numbering System

Multilayer Ceramic Capacitors:

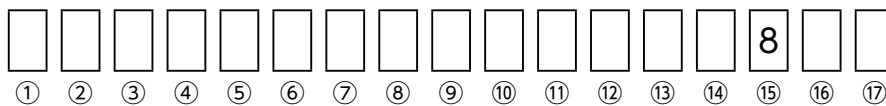

If the 15th code from the left is “8”, it indicates “For Telecommunications Infrastructure and Industrial Equipment” or “For Medical Devices”.

Inductors:

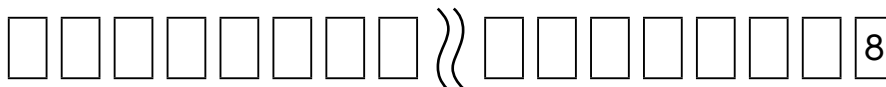

If the 1st code from the right is “8” regardless of the total digit number, it indicates “For Telecommunications Infrastructure and Industrial Equipment” or “For Medical Devices”.

Because there are some exceptions, for details please refer to each page of this catalog where the part numbering system of each product is described.

▶ This catalog contains the typical specification only due to the limitation of space. When you consider the purchase of our products, please check our product specification sheets. For details of each product (characteristics graph, reliability information, precautions for use, and so on), see our website (<http://www.ty-top.com/>).

Medical Application Guide

The products described as “For Medical Devices” in this catalog are intended for use in the medical devices classified as GHTF Classes A to C (Japan Classes I to III) except for all medical devices classified as GHTF Class D (Japan Class IV) and implantable medical devices (bone-anchored hearing aid, artificial retina system, and external unit which is connected to internal unit which is implanted in a body, etc.). Therefore, when using our products for these medical devices, please check it carefully by referring to the part number or the individual product specification sheets and use the corresponding products. Should you have any questions on this matter, please contact us.

Risk Level					
Japan	Classification according to the PMD Act of Japan (based on the GHTF Rules)	Class I General Medical Devices (GHTF Class A)	Class II Controlled Medical Devices (GHTF Class B)	Class III Specially-controlled Medical Devices (GHTF Class C)	Class IV Specially-controlled Medical Devices (GHTF Class D)
		Medical devices with extremely low risk to the human body in case of problems [Ex.] • In Vitro Diagnostic Devices • Nebulizer • Blood Gas Analyzer • Plethysmographs • Breathing Sensor • AC-powered Operating Table • Surgical Light • Cholesterol Analysis Device • Blood Type Analysis Device, etc.	Medical devices with relatively low risk to the human body in case of problems [Ex.] • Electronic Thermometer • Electronic Blood Pressure Gauge • Electronic Endoscope • Hearing Aid • Electrocardiograph • MRI • Ultrasonic Diagnostic System • Diagnostic Imaging Equipment • X-ray Diagnostic Equipment • Central Monitor • Pulse Oximeter, etc.	Medical devices with relatively high risk to the human body in case of problems [Ex.] • Dialysis Machine • Radiation Therapy Equipment • Infusion Pump • Respirator • Glucose Monitoring System • AED (Automated External Defibrillator) • Skin Laser Scanner • Electric Surgical Unit • Insulin Pump, etc.	Medical devices highly invasive to patients and with life-threatening risk in case of problems [Ex.] • Cardiac Pacemaker • Video Flexible Angioscope • Implantable Infusion Pump • Cardiac Electrosurgical Unit • Inspection Device with Cardiac Catheter • Defibrillator, etc.
U.S.A.	FDA Classification	Class I General Controls	Class II General Controls and Special Controls	Class III General Controls and Premarket Approval	
		Medical devices without the possibility of causing serious injury or harm to the patient or user even if there is a defect or malfunction in such medical devices	Medical devices with the possibility of causing injury or harm to the patient or user if there is a defect or malfunction in such medical devices	Medical devices with the possibility of causing serious injury, disability or death to the patient or user if a defect or malfunction occurs in such medical devices	

Coverage of those Classes by TAIYO YUDEN Products	Product Series for Medical Devices *Note: It is prohibited that our products are used in some medical devices such as implantable medical devices even if such medical devices are classified as GHTF Class C (Japan Class III).	N/A
---	--	-----

► This catalog contains the typical specification only due to the limitation of space. When you consider the purchase of our products, please check our product specification sheets. For details of each product (characteristics graph, reliability information, precautions for use, and so on), see our website (<http://www.ty-top.com/>).

MULTILAYER CERAMIC CAPACITORS

REFLOW

AEC-Q200

■ PART NUMBER

J	M	K	3	1	6	△	B	J	1	0	6	M	L	H	T	△
①	②	③	④	⑤	⑥	⑦	⑧	⑨	⑩	⑪	⑫					

△ = Blank space

① Rated voltage

Code	Rated voltage [VDC]
A	4
J	6.3
L	10
E	16
T	25
G	35
U	50
H	100
Q	250
S	630

③ End termination

Code	End termination
K	Plated
J	Soft Termination
S	Cu Internal Electrodes (For High Frequency)
F	High Reliability Application
R	High Reliability Application (Cu External Electrodes)

② Series name

Code	Series name
M	Multilayer ceramic capacitor
V	Multilayer ceramic capacitor for high frequency
W	LW reverse type multilayer capacitor

④ Dimension (L × W)

Type	Dimensions (L × W) [mm]	EIA (inch)
063	0.6 × 0.3	0201
105	1.0 × 0.5	0402
	0.52 × 1.0 ※	0204
107	1.6 × 0.8	0603
	0.8 × 1.6 ※	0306
212	2.0 × 1.25	0805
	1.25 × 2.0 ※	0508
316	3.2 × 1.6	1206
325	3.2 × 2.5	1210
432	4.5 × 3.2	1812

Note : ※LW reverse type (□WK) only

⑤ Dimension tolerance

Code	Type	L [mm]	W [mm]	T [mm]
△	ALL	Standard	Standard	Standard
A	063	0.6 ± 0.05	0.3 ± 0.05	0.3 ± 0.05
	105	1.0 ± 0.10	0.5 ± 0.10	0.5 ± 0.10
	107	1.6 + 0.15 / - 0.05	0.8 + 0.15 / - 0.05	0.8 + 0.15 / - 0.05
	212	2.0 + 0.15 / - 0.05	1.25 + 0.15 / - 0.05	0.85 ± 0.10 1.25 + 0.15 / - 0.05
	316	3.2 ± 0.20	1.6 ± 0.20	1.6 ± 0.20
	325	3.2 ± 0.30	2.5 ± 0.30	2.5 ± 0.30
B	105	1.0 + 0.15 / - 0.05	0.5 + 0.15 / - 0.05	0.5 + 0.15 / - 0.05
	107	1.6 + 0.20 / - 0	0.8 + 0.20 / - 0	0.8 + 0.20 / - 0
	212	2.0 + 0.20 / - 0	1.25 + 0.20 / - 0	0.85 ± 0.10 1.25 + 0.20 / - 0
C	105	1.0 + 0.20 / - 0	0.5 + 0.20 / - 0	0.5 + 0.20 / - 0
	107	1.6 + 0.25 / - 0	0.8 + 0.25 / - 0	0.8 + 0.25 / - 0
	212	2.0 + 0.25 / - 0	1.25 + 0.25 / - 0	1.25 + 0.25 / - 0
K	212	2.0 ± 0.15	1.25 ± 0.15	0.85 ± 0.15
	316	3.2 ± 0.20	1.6 ± 0.20	1.15 ± 0.20 1.6 ± 0.20
	325	3.2 ± 0.50	2.5 ± 0.30	2.5 ± 0.30

Note: cf. STANDARD EXTERNAL DIMENSIONS

△ = Blank space

⑥ Temperature characteristics code

■ High dielectric type

Code	Applicable standard		Temperature range [°C]	Ref. Temp. [°C]	Capacitance change	Capacitance tolerance	Tolerance code
BJ	EIA	X5R	-55 ~ + 85	25	± 15%	± 10%	K
						± 20%	M
C6	EIA	X6S	-55 ~ + 105	25	± 22%	± 10%	K
						± 20%	M
B7	EIA	X7R	-55 ~ + 125	25	± 15%	± 10%	K
						± 20%	M
C7	EIA	X7S	-55 ~ + 125	25	± 22%	± 10%	K
						± 20%	M
D7	EIA	X7T	-55 ~ + 125	25	+ 22% / - 33%	± 10%	K
						± 20%	M

▶ This catalog contains the typical specification only due to the limitation of space. When you consider the purchase of our products, please check our product specification sheets. For details of each product (characteristics graph, reliability information, precautions for use, and so on), see our website (<http://www.ty-top.com/>).

CERAMIC CAPACITORS INDL For Telecommunications Infrastructure and Industrial Equipment / Medical Devices MULTILAYER CERAMIC CAPACITORS

■ Temperature compensating type

Code	Applicable standard		Temperature range [°C]	Ref. Temp. [°C]	Capacitance change	Capacitance tolerance	Tolerance code
CG	JIS	CG	-55~+125	20	0±30ppm/°C	±0.1pF	B
						±0.25pF	C
						±0.5pF	D
	EIA	C0G		25		±1pF	F
						±2%	G
						±5%	J

⑦ Nominal capacitance

Code (example)	Nominal capacitance
0R5	0.5pF
010	1pF
100	10pF
101	100pF
102	1,000pF
103	0.01 μF
104	0.1 μF
105	1.0 μF
106	10 μF
107	100 μF

Note : R=Decimal point

⑧ Capacitance tolerance

Code	Capacitance tolerance
A	±0.05pF
B	±0.1pF
C	±0.25pF
D	±0.5pF
G	±2%
J	±5%
K	±10%
M	±20%

⑨ Thickness

Code	Thickness [mm]
P	0.3
T	
V	0.5
C	0.7(107type or more)
A	0.8
D	0.85(212type or more)
F	1.15
G	1.25
L	1.6
N	1.9
M	2.5

⑩ Special code

Code	Special code
-	Standard
H	MLCC for Automotive
8	MLCC for Telecommunications infrastructure and Industrial equipment / Medical devices

⑪ Packaging

Code	Packaging
F	φ 178mm Taping (2mm pitch)
R	φ 178mm Embossed Taping (4mm pitch)
T	φ 178mm Taping (4mm pitch)
P	φ 178mm Taping (4mm pitch, 1000 pcs/reel) 325 type (Thickness code M)

⑫ Internal code

Code	Internal code
△	Standard

► This catalog contains the typical specification only due to the limitation of space. When you consider the purchase of our products, please check our product specification sheets. For details of each product (characteristics graph, reliability information, precautions for use, and so on), see our website (<http://www.ty-top.com/>).

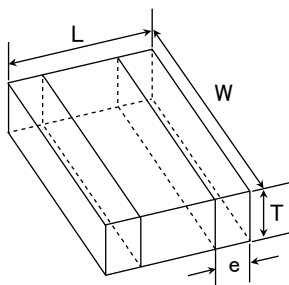
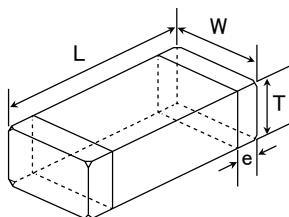

※ LW reverse type

Type(EIA)	Dimension [mm] (inch)				
	L	W	T	*1	e
□MK063(0201)	0.6±0.03 (0.024±0.001)	0.3±0.03 (0.012±0.001)	0.3±0.03 (0.012±0.001)	T	0.15±0.05 (0.006±0.002)
□MK105(0402) □MF105(0402)	1.0±0.05 (0.039±0.002)	0.5±0.05 (0.020±0.002)	0.5±0.05 (0.020±0.002)	V	0.25±0.10 (0.010±0.004)
□WK105(0204)※	0.52±0.05 (0.020±0.002)	1.0±0.05 (0.039±0.002)	0.3±0.05 (0.012±0.002)	P	0.18±0.08 (0.007±0.003)
□MK107(0603) □MF107(0603)	1.6±0.10 (0.063±0.004)	0.8±0.10 (0.031±0.004)	0.8±0.10 (0.031±0.004)	A	0.35±0.25 (0.014±0.010)
□MJ107(0603)	1.6±0.10 (0.063±0.004)	0.8±0.10 (0.031±0.004)	0.8±0.10 (0.031±0.004)	A	0.35+0.3/-0.25 (0.014+0.012/-0.010)
□VS107(0603)	1.6±0.10 (0.063±0.004)	0.8±0.10 (0.031±0.004)	0.7±0.10 (0.028±0.004)	C	0.35±0.25 (0.014±0.010)
□WK107(0306)※	0.8±0.10 (0.031±0.004)	1.6±0.10 (0.063±0.004)	0.5±0.05 (0.020±0.002)	V	0.25±0.15 (0.010±0.006)
□MK212(0805) □MF212(0805)	2.0±0.10 (0.079±0.004)	1.25±0.10 (0.049±0.004)	0.85±0.10 (0.033±0.004)	D	0.5±0.25 (0.020±0.010)
1.25±0.10 (0.049±0.004)			G		
□MJ212(0805)	2.0±0.10 (0.079±0.004)	1.25±0.10 (0.049±0.004)	0.85±0.10 (0.033±0.004)	D	0.5+0.35/-0.25 (0.020+0.014/-0.010)
1.25±0.10 (0.049±0.004)			G		
□VS212(0805)	2.0±0.10 (0.079±0.004)	1.25±0.10 (0.049±0.004)	0.85±0.10 (0.033±0.004)	D	0.5±0.25 (0.020±0.010)
□WK212(0508)※	1.25±0.15 (0.049±0.006)	2.0±0.15 (0.079±0.006)	0.85±0.10 (0.033±0.004)	D	0.3±0.2 (0.012±0.008)
□MK316(1206) □MF316(1206)	3.2±0.15 (0.126±0.006)	1.6±0.15 (0.063±0.006)	1.15±0.10 (0.045±0.004)	F	0.5+0.35/-0.25 (0.020+0.014/-0.010)
1.6±0.20 (0.063±0.008)			L		
□MJ316(1206)	3.2±0.15 (0.126±0.006)	1.6±0.15 (0.063±0.006)	1.15±0.10 (0.045±0.004)	F	0.6+0.4/-0.3 (0.024+0.016/-0.012)
1.6±0.20 (0.063±0.008)			L		
□MK325(1210) □MF325(1210)	3.2±0.30 (0.126±0.012)	2.5±0.20 (0.098±0.008)	1.15±0.10 (0.045±0.004)	F	0.6±0.3 (0.024±0.012)
1.9±0.20 (0.075±0.008)			N		
2.5±0.20 (0.098±0.008)			M		
□MJ325(1210)	3.2±0.30 (0.126±0.012)	2.5±0.20 (0.098±0.008)	1.9±0.20 (0.075±0.008)	N	0.6+0.4/-0.3 (0.024+0.016/-0.012)
2.5±0.20 (0.098±0.008)			M		
□MK432(1812)	4.5±0.40 (0.177±0.016)	3.2±0.30 (0.126±0.012)	2.5±0.20 (0.098±0.008)	M	0.9±0.6 (0.035±0.024)

Note : ※. LW reverse type, *1.Thickness code

■ STANDARD QUANTITY

Type	EIA (inch)	Dimension		Standard quantity [pcs]	
		[mm]	Code	Paper tape	Embossed tape
063	0201	0.3	T	15000	—
105	0402	0.5	V	10000	—
	0204 ※	0.30	P		
107	0603	0.7	C	4000	—
		0.8	A		
		0.8	A	3000 (Soft Termination)	—
		0.8	A	—	3000 (Soft Termination)
	0306 ※	0.50	V	—	4000
212	0805	0.85	D	4000	—
		1.25	G	—	3000
		1.25	G	—	2000 (Soft Termination)
	0508 ※	0.85	D	4000	—
316	1206	1.15	F	—	3000
		1.6	L	—	2000
325	1210	1.15	F	—	2000
		1.9	N		
		2.5	M	—	500 (T), 1000 (P)
432	1812	2.5	M	—	500

Note : ※.LW Reverse type (□WK)

► This catalog contains the typical specification only due to the limitation of space. When you consider the purchase of our products, please check our product specification sheets. For details of each product (characteristics graph, reliability information, precautions for use, and so on), see our website (<http://www.ty-top.com/>).

PART NUMBER

- All the Multilayer Ceramic Capacitors of the catalog lineup are RoHS compliant.
- Capacitance tolerance code is applied to □ of part number.
- All the Multilayer Ceramic Capacitors in the catalog lineup are applicable for reflow-soldering.

Notes)

- The exchange of individual specifications is necessary depending on your application and/or circuit condition. Please contact TAIYO YUDEN's official sales channel.
- The products are for Telecommunications infrastructure and Industrial equipment and for Medical devices.
Please consult with TAIYO YUDEN's official sales channel for the details of the product specifications, etc., and please review and approve the product specifications before ordering.
- Please be sure to contact us for further information in advance when the products are used for automotive electronic equipment.
- *1: For standard case size, please kindly refer to ④Dimension, ⑤Dimension tolerance, ⑨Thickness and STANDARD EXTERNAL DIMENSIONS.

Multilayer Ceramic Capacitors (High dielectric type)

● 063TYPE (Dimension:0.6×0.3mm JIS:1005 EIA:0402)

【Temperature Characteristic B7 : X7R(−55~+125°C)】 0.3mm thickness(P)

Part number 1	Part number 2	Rated voltage [V]	Temperature characteristics	Capacitance [F]	Capacitance tolerance [%]	tan δ [%]	HTLT		Thickness*1 [mm]	Note
							Rated voltage x %			
TMK063 B7101□P8FE		25	X7R	100 p	±10, ±20	3.5	200	0.3±0.03		
TMK063 B7151□P8FE			X7R	150 p	±10, ±20	3.5	200	0.3±0.03		
TMK063 B7221□P8FE			X7R	220 p	±10, ±20	3.5	200	0.3±0.03		
TMK063 B7331□P8FE			X7R	330 p	±10, ±20	3.5	200	0.3±0.03		
TMK063 B7471□P8FE			X7R	470 p	±10, ±20	3.5	200	0.3±0.03		
TMK063 B7102□P8FE			X7R	1000 p	±10, ±20	5	200	0.3±0.03		
TMK063 B7152□P8FE			X7R	1500 p	±10, ±20	5	200	0.3±0.03		
TMK063 B7222□P8FE			X7R	2200 p	±10, ±20	5	200	0.3±0.03		
TMK063 B7332□P8FE			X7R	3300 p	±10, ±20	5	200	0.3±0.03		
EMK063 B7101□P8FE			16	X7R	100 p	±10, ±20	3.5	200	0.3±0.03	
EMK063 B7151□P8FE				X7R	150 p	±10, ±20	3.5	200	0.3±0.03	
EMK063 B7221□P8FE				X7R	220 p	±10, ±20	3.5	200	0.3±0.03	
EMK063 B7331□P8FE		X7R		330 p	±10, ±20	3.5	200	0.3±0.03		
EMK063 B7471□P8FE		X7R		470 p	±10, ±20	3.5	200	0.3±0.03		
EMK063 B7102□P8FE		X7R		1000 p	±10, ±20	5	200	0.3±0.03		
EMK063 B7152□P8FE		X7R		1500 p	±10, ±20	5	200	0.3±0.03		
EMK063 B7222□P8FE		X7R		2200 p	±10, ±20	5	200	0.3±0.03		
EMK063 B7332□P8FE		X7R		3300 p	±10, ±20	5	200	0.3±0.03		
LMK063 B7101□P8FE		10		X7R	100 p	±10, ±20	3.5	200	0.3±0.03	
LMK063 B7151□P8FE				X7R	150 p	±10, ±20	3.5	200	0.3±0.03	
LMK063 B7221□P8FE				X7R	220 p	±10, ±20	3.5	200	0.3±0.03	
LMK063 B7331□P8FE			X7R	330 p	±10, ±20	3.5	200	0.3±0.03		
LMK063 B7471□P8FE			X7R	470 p	±10, ±20	3.5	200	0.3±0.03		
LMK063 B7102□P8FE			X7R	1000 p	±10, ±20	5	200	0.3±0.03		
LMK063 B7152□P8FE			X7R	1500 p	±10, ±20	5	200	0.3±0.03		
LMK063 B7222□P8FE			X7R	2200 p	±10, ±20	5	200	0.3±0.03		
LMK063 B7332□P8FE			X7R	3300 p	±10, ±20	5	200	0.3±0.03		
LMK063 B7472□P8FE			X7R	4700 p	±10, ±20	5	200	0.3±0.03		
LMK063 B7682□P8FE			X7R	6800 p	±10, ±20	5	200	0.3±0.03		
LMK063 B7103□P8FE			X7R	10000 p	±10, ±20	5	200	0.3±0.03		

▶ This catalog contains the typical specification only due to the limitation of space. When you consider the purchase of our products, please check our product specification sheets. For details of each product (characteristics graph, reliability information, precautions for use, and so on), see our website (<http://www.ty-top.com/>).

■ PART NUMBER

● 105TYPE (Dimension:1.0×0.5mm JIS:1005 EIA:0402)

【Temperature Characteristic BJ : X5R(−55~+85°C)】 0.5mm thickness(V)

Part number 1	Part number 2	Rated voltage [V]	Temperature characteristics	Capacitance [F]	Capacitance tolerance [%]	tan δ [%]	HTLT	Thickness*1 [mm]	Note	
							Rated voltage x %			
UMK105 BJ471□V8F		50	X5R	470 p	±10, ±20	2.5	200	0.5±0.05		
UMK105 BJ102□V8F			X5R	1000 p	±10, ±20	2.5	200	0.5±0.05		
UMK105 BJ152□V8F			X5R	1500 p	±10, ±20	2.5	200	0.5±0.05		
UMK105 BJ222□V8F			X5R	2200 p	±10, ±20	2.5	200	0.5±0.05		
UMK105 BJ332□V8F			X5R	3300 p	±10, ±20	2.5	200	0.5±0.05		
UMK105 BJ472□V8F			X5R	4700 p	±10, ±20	2.5	200	0.5±0.05		
UMK105 BJ682□V8F			X5R	6800 p	±10, ±20	2.5	150	0.5±0.05		
UMK105 BJ103□V8F			X5R	0.01 μ	±10, ±20	3.5	200	0.5±0.05		
UMK105 BJ223□V8F			X5R	0.022 μ	±10, ±20	5	200	0.5±0.05		
UMK105 BJ473□V8F			X5R	0.047 μ	±10, ±20	5	200	0.5±0.05		
UMK105 BJ104□V8F			X5R	0.1 μ	±10, ±20	10	150	0.5±0.05		
TMK105 BJ472□V8F			25	X5R	4700 p	±10, ±20	2.5	200	0.5±0.05	
TMK105 BJ682□V8F				X5R	6800 p	±10, ±20	2.5	200	0.5±0.05	
TMK105 BJ103□V8F				X5R	0.01 μ	±10, ±20	3.5	200	0.5±0.05	
TMK105 BJ153□V8F				X5R	0.015 μ	±10, ±20	3.5	200	0.5±0.05	
TMK105 BJ223□V8F				X5R	0.022 μ	±10, ±20	3.5	200	0.5±0.05	
TMK105 BJ333□V8F				X5R	0.033 μ	±10, ±20	3.5	150	0.5±0.05	
TMK105 BJ473□V8F				X5R	0.047 μ	±10, ±20	3.5	150	0.5±0.05	
TMK105 BJ104□V8F		X5R		0.1 μ	±10, ±20	5	150	0.5±0.05		
TMK105 BJ224□V8F		X5R		0.22 μ	±10, ±20	10	150	0.5±0.05		
TMK105ABJ474□V8F		X5R		0.47 μ	±10, ±20	10	150	0.5±0.10		
EMK105 BJ104□V8F		16		X5R	0.1 μ	±10, ±20	5	150	0.5±0.05	
EMK105 BJ224□V8F				X5R	0.22 μ	±10, ±20	10	150	0.5±0.05	
EMK105ABJ474□V8F				X5R	0.47 μ	±10, ±20	10	150	0.5±0.10	
EMK105 BJ105□V8F				X5R	1 μ	±10, ±20	10	150	0.5±0.05	
LMK105 BJ224□V8F		10		X5R	0.22 μ	±10, ±20	5	150	0.5±0.05	
LMK105ABJ474□V8F				X5R	0.47 μ	±10, ±20	10	150	0.5±0.10	
LMK105 BJ105□V8F				X5R	1 μ	±10, ±20	10	150	0.5±0.05	
LMK105ABJ225□V8F				X5R	2.2 μ	±10, ±20	10	150	0.5±0.10	
JMK105 BJ474□V8F		6.3	X5R	0.47 μ	±10, ±20	10	150	0.5±0.05		
JMK105 BJ105□V8F			X5R	1 μ	±10, ±20	10	150	0.5±0.05		
JMK105 BJ225□V8F			X5R	2.2 μ	±10, ±20	10	150	0.5±0.05		
JMK105BBJ475MV8F			X5R	4.7 μ	±20	10	150	0.5+0.15/-0.05		
AMK105 BJ225□V8F		4	X5R	2.2 μ	±10, ±20	10	150	0.5±0.05		
AMK105BBJ475MV8F			X5R	4.7 μ	±20	10	150	0.5+0.15/-0.05		

【Temperature Characteristic B7 : X7R(−55~+125°C), D7 : X7T(−55~+125°C)】 0.5mm thickness(V)

Part number 1	Part number 2	Rated voltage [V]	Temperature characteristics	Capacitance [F]	Capacitance tolerance [%]	tan δ [%]	HTLT	Thickness*1 [mm]	Note		
							Rated voltage x %				
UMK105 B7221□V8F		50	X7R	220 p	±10, ±20	2.5	200	0.5±0.05			
UMK105 B7331□V8F			X7R	330 p	±10, ±20	2.5	200	0.5±0.05			
UMK105 B7471□V8F			X7R	470 p	±10, ±20	2.5	200	0.5±0.05			
UMK105 B7681□V8F			X7R	680 p	±10, ±20	2.5	200	0.5±0.05			
UMK105 B7102□V8F			X7R	1000 p	±10, ±20	2.5	200	0.5±0.05			
UMK105 B7152□V8F			X7R	1500 p	±10, ±20	2.5	200	0.5±0.05			
UMK105 B7222□V8F			X7R	2200 p	±10, ±20	2.5	200	0.5±0.05			
UMK105 B7332□V8F			X7R	3300 p	±10, ±20	2.5	200	0.5±0.05			
UMK105 B7472□V8F			X7R	4700 p	±10, ±20	2.5	150	0.5±0.05			
UMK105 B7682□V8F			X7R	6800 p	±10, ±20	2.5	150	0.5±0.05			
UMK105 B7103□V8F			X7R	0.01 μ	±10, ±20	3.5	150	0.5±0.05			
UMK105 B7153□V8FE			X7R	0.015 μ	±10, ±20	3.5	200	0.5±0.05			
UMK105 B7223□V8F			X7R	0.022 μ	±10, ±20	10	200	0.5±0.05			
UMK105 B7333□V8FE			X7R	0.033 μ	±10, ±20	3.5	150	0.5±0.05			
UMK105 B7473□V8F			X7R	0.047 μ	±10, ±20	10	200	0.5±0.05			
UMK105 B7104□V8F			X7R	0.1 μ	±10, ±20	10	150	0.5±0.05			
TMK105 B7472□V8F			25	X7R	4700 p	±10, ±20	2.5	200	0.5±0.05		
TMK105 B7682□V8F				X7R	6800 p	±10, ±20	2.5	200	0.5±0.05		
TMK105 B7103□V8F				X7R	0.01 μ	±10, ±20	3.5	200	0.5±0.05		
TMK105 B7153□V8F				X7R	0.015 μ	±10, ±20	3.5	150	0.5±0.05		
TMK105 B7223□V8F				X7R	0.022 μ	±10, ±20	3.5	150	0.5±0.05		
TMK105 B7333□V8F				X7R	0.033 μ	±10, ±20	3.5	150	0.5±0.05		
TMK105 B7473□V8F				X7R	0.047 μ	±10, ±20	3.5	150	0.5±0.05		
TMK105 B7104□V8F				X7R	0.1 μ	±10, ±20	10	150	0.5±0.05		
EMK105 B7103□V8F				16	X7R	0.01 μ	±10, ±20	3.5	200	0.5±0.05	
EMK105 B7153□V8F					X7R	0.015 μ	±10, ±20	3.5	150	0.5±0.05	
EMK105 B7223□V8F					X7R	0.022 μ	±10, ±20	3.5	150	0.5±0.05	
EMK105 B7333□V8F					X7R	0.033 μ	±10, ±20	3.5	150	0.5±0.05	
EMK105 B7473□V8F			X7R		0.047 μ	±10, ±20	3.5	150	0.5±0.05		
EMK105 B7104□V8F			X7R		0.1 μ	±10, ±20	5	150	0.5±0.05		
EMK105 B7224□V8F			10	X7R	0.22 μ	±10, ±20	10	150	0.5±0.05		
LMK105 B7473□V8F				X7R	0.047 μ	±10, ±20	3.5	150	0.5±0.05		
LMK105 B7104□V8F				X7R	0.1 μ	±10, ±20	5	150	0.5±0.05		
LMK105 B7224□V8F				X7R	0.22 μ	±10, ±20	10	150	0.5±0.05		
JMK105 B7104□V8F				6.3	X7R	0.1 μ	±10, ±20	5	150	0.5±0.05	
JMK105 B7224□V8F					X7R	0.22 μ	±10, ±20	10	150	0.5±0.05	
JMK105 B7474□V8F		X7R	0.47 μ		±10, ±20	10	150	0.5±0.05			
JMK105CD7105□V8F		X7T	1 μ		±10, ±20	10	150	0.5+0.2/-0			
AMK105 B7474□V8F		4	X7R	0.47 μ	±10, ±20	10	150	0.5±0.05			

▶ This catalog contains the typical specification only due to the limitation of space. When you consider the purchase of our products, please check our product specification sheets. For details of each product (characteristics graph, reliability information, precautions for use, and so on), see our website (<http://www.ty-top.com/>).

■ PART NUMBER

● 107TYPE (Dimension:1.6 × 0.8mm JIS:1608 EIA:0603)

【Temperature Characteristic BJ : X5R(−55~+85°C)】 0.8mm thickness(A)

Part number 1	Part number 2	Rated voltage [V]	Temperature characteristics	Capacitance [F]	Capacitance tolerance [%]	tan δ [%]	HTLT		Thickness*1 [mm]	Note
							Rated voltage x %			
UMK107 BJ224□A8T		50	X5R	0.22 μ	±10, ±20	10	150		0.8±0.10	
UMK107 BJ474□A8T			X5R	0.47 μ	±10, ±20	10	150		0.8±0.10	
UMK107ABJ105□A8T			X5R	1 μ	±10, ±20	10	150		0.8+0.15/-0.05	
GMK107 BJ224□A8T		35	X5R	0.22 μ	±10, ±20	10	150		0.8±0.10	
GMK107ABJ474□A8T			X5R	0.47 μ	±10, ±20	10	150		0.8+0.15/-0.05	
GMK107 BJ105□A8T			X5R	1 μ	±10, ±20	10	150		0.8±0.10	
TMK107 BJ224□A8T		25	X5R	0.22 μ	±10, ±20	5	150		0.8±0.10	
TMK107 BJ474□A8T			X5R	0.47 μ	±10, ±20	3.5	150		0.8±0.10	
TMK107 BJ105□A8T			X5R	1 μ	±10, ±20	10	150		0.8±0.10	
TMK107BBJ225□A8T		16	X5R	2.2 μ	±10, ±20	10	150		0.8+0.20/-0	
EMK107 BJ105□A8T			X5R	1 μ	±10, ±20	5	150		0.8±0.10	
EMK107ABJ225□A8T			X5R	2.2 μ	±10, ±20	10	150		0.8+0.15/-0.05	
EMK107BBJ475□A8T		10	X5R	4.7 μ	±10, ±20	10	150		0.8+0.20/-0	
LМК107 BJ225□A8T			X5R	2.2 μ	±10, ±20	10	150		0.8±0.10	
LМК107 BJ475□A8T			X5R	4.7 μ	±10, ±20	10	150		0.8±0.10	
LМК107BBJ106MA8T		6.3	X5R	10 μ	±20	10	150		0.8+0.20/-0	
JMK107 BJ475□A8T			X5R	4.7 μ	±10, ±20	10	150		0.8±0.10	
JMK107ABJ106□A8T			X5R	10 μ	±10, ±20	10	150		0.8+0.15/-0.05	
AMK107ABJ106□A8T		4	X5R	10 μ	±10, ±20	10	150		0.8+0.15/-0.05	
AMK107BBJ226MA8T			X5R	22 μ	±20	10	150		0.8+0.20/-0	

【Temperature Characteristic B7 : X7R(−55~+125°C), C7 : X7S(−55~+125°C), D7 : X7T(−55~+125°C)】 0.8mm thickness(A)

Part number 1	Part number 2	Rated voltage [V]	Temperature characteristics	Capacitance [F]	Capacitance tolerance [%]	tan δ [%]	HTLT		Thickness*1 [mm]	Note
							Rated voltage x %			
UMK107AC7154□A8TE		50	X7S	0.15 μ	±10, ±20	3.5	150		0.8+0.15/-0.05	
UMK107 C7224□A8TE			X7S	0.22 μ	±10, ±20	3.5	150		0.8±0.10	
GMK107 B7224□A8T		35	X7R	0.22 μ	±10, ±20	10	150		0.8±0.10	
GMK107 B7474□A8T			X7R	0.47 μ	±10, ±20	10	150		0.8±0.10	
GMK107AB7105□A8T		25	X7R	1 μ	±10, ±20	10	150		0.8+0.15/-0.05	
TMK107 B7224□A8T			X7R	0.22 μ	±10, ±20	10	150		0.8±0.10	
TMK107 B7474□A8T			X7R	0.47 μ	±10, ±20	10	150		0.8±0.10	
TMK107AB7105□A8T		16	X7R	1 μ	±10, ±20	10	150		0.8+0.15/-0.05	
EMK107 B7224□A8T			X7R	0.22 μ	±10, ±20	5	150		0.8±0.10	
EMK107 B7474□A8T			X7R	0.47 μ	±10, ±20	10	150		0.8±0.10	
EMK107 B7105□A8T		10	X7R	1 μ	±10, ±20	10	150		0.8±0.10	
LМК107 B7474□A8T			X7R	0.47 μ	±10, ±20	3.5	150		0.8±0.10	
LМК107 B7105□A8T			X7R	1 μ	±10, ±20	10	150		0.8±0.10	
LМК107BD7225□A8T		6.3	X7T	2.2 μ	±10, ±20	10	200		0.8+0.20/-0	
JMK107 B7105□A8T			X7R	1 μ	±10, ±20	10	150		0.8±0.10	
JMK107 B7225□A8TR		X7R	2.2 μ	±10, ±20	10	150		0.8±0.10		

CERAMIC CAPACITORS

INDL

For Telecommunications Infrastructure and Industrial Equipment / Medical Devices
MULTILAYER CERAMIC CAPACITORS(HIGH DIELECTRIC TYPE)

▶ This catalog contains the typical specification only due to the limitation of space. When you consider the purchase of our products, please check our product specification sheets. For details of each product (characteristics graph, reliability information, precautions for use, and so on), see our website (<http://www.ty-top.com/>).

■ PART NUMBER

● 212TYPE (Dimension:2.0×1.25mm JIS:2012 EIA:0805)

【Temperature Characteristic BJ : X5R(−55~+85°C)】 1.25mm thickness (G)

Part number 1	Part number 2	Rated voltage [V]	Temperature characteristics	Capacitance [F]	Capacitance tolerance [%]	tan δ [%]	HTLT	Thickness*1 [mm]	Note
							Rated voltage x %		
UMK212 BJ474□G8T		50	X5R	0.47 μ	±10, ±20	3.5	150	1.25±0.10	
UMK212 BJ105□G8T			X5R	1 μ	±10, ±20	5	150	1.25±0.10	
GMK212 BJ105□G8T			X5R	1 μ	±10, ±20	5	150	1.25±0.10	
GMK212BBJ225□G8T		35	X5R	2.2 μ	±10, ±20	10	150	1.25+0.20/-0	
TMK212 BJ225□G8T			X5R	2.2 μ	±10, ±20	5	150	1.25±0.10	
TMK212BBJ475□G8T			X5R	4.7 μ	±10, ±20	10	150	1.25+0.20/-0	
TMK212BBJ106□G8T		25	X5R	10 μ	±10, ±20	10	150	1.25+0.20/-0	
EMK212 BJ225□G8T			X5R	2.2 μ	±10, ±20	5	150	1.25±0.10	
EMK212ABJ475□G8T			X5R	4.7 μ	±10, ±20	10	150	1.25+0.15/-0.05	
EMK212BBJ106□G8T		16	X5R	10 μ	±10, ±20	10	150	1.25+0.20/-0	
LMK212ABJ475□G8T			X5R	4.7 μ	±10, ±20	10	150	1.25+0.15/-0.05	
LMK212ABJ106□G8T			X5R	10 μ	±10, ±20	10	150	1.25+0.15/-0.05	
JMK212ABJ106□G8T		6.3	X5R	10 μ	±10, ±20	10	150	1.25+0.15/-0.05	
JMK212BBJ226MG8T			X5R	22 μ	±20	10	150	1.25+0.20/-0	
AMK212BBJ476MG8T			X5R	47 μ	±20	10	150	1.25+0.20/-0	

【Temperature Characteristic BJ : X5R(−55~+85°C)】 0.85mm thickness (D)

Part number 1	Part number 2	Rated voltage [V]	Temperature characteristics	Capacitance [F]	Capacitance tolerance [%]	tan δ [%]	HTLT	Thickness*1 [mm]	Note
							Rated voltage x %		
EMK212ABJ225□D8T		16	X5R	2.2 μ	±10, ±20	5	150	0.85±0.10	
EMK212BBJ475□D8T			X5R	4.7 μ	±10, ±20	10	150	0.85±0.10	

【Temperature Characteristic B7 : X7R(−55~+125°C)】 1.25mm thickness (G)

Part number 1	Part number 2	Rated voltage [V]	Temperature characteristics	Capacitance [F]	Capacitance tolerance [%]	tan δ [%]	HTLT	Thickness*1 [mm]	Note	
							Rated voltage x %			
UMK212 B7473□G8T		50	X7R	0.047 μ	±10, ±20	3.5	200	1.25±0.10		
UMK212 B7683□G8T			X7R	0.068 μ	±10, ±20	3.5	200	1.25±0.10		
UMK212 B7104□G8T			X7R	0.1 μ	±10, ±20	3.5	200	1.25±0.10		
UMK212BB7154□G8TE			X7R	0.15 μ	±10, ±20	3.5	200	1.25+0.20/-0		
UMK212 B7224□G8T			X7R	0.22 μ	±10, ±20	3.5	150	1.25±0.10		
UMK212BC7334□G8TE			X7S	0.33 μ	±10, ±20	3.5	150	1.25+0.20/-0		
UMK212 C7474□G8TE			X7S	0.47 μ	±10, ±20	3.5	150	1.25±0.10		
UMK212CC7684□G8TE			X7S	0.68 μ	±10, ±20	3.5	150	1.25+0.25/-0		
UMK212 B7105□G8T			X7R	1 μ	±10, ±20	10	150	1.25±0.10		
GMK212 B7105□G8T			35	X7R	1 μ	±10, ±20	10	150	1.25±0.10	
TMK212 B7474□G8T				X7R	0.47 μ	±10, ±20	3.5	150	1.25±0.10	
TMK212 B7105□G8TR			25	X7R	1 μ	±10, ±20	10	150	1.25±0.10	
TMK212 B7225□G8T				X7R	2.2 μ	±10, ±20	10	150	1.25±0.10	
EMK212 B7105□G8TR		16	X7R	1 μ	±10, ±20	10	150	1.25±0.10		
EMK212 B7225□G8T			X7R	2.2 μ	±10, ±20	10	150	1.25±0.10		
EMK212AB7475□G8T			X7R	4.7 μ	±10, ±20	10	150	1.25+0.15/-0.05		
LMK212 B7225□G8T		10	X7R	2.2 μ	±10, ±20	10	150	1.25±0.10		
LMK212 B7475□G8T			X7R	4.7 μ	±10, ±20	10	150	1.25±0.10		
JMK212 B7475□G8T		6.3	X7R	4.7 μ	±10, ±20	10	150	1.25±0.10		
JMK212AB7106□G8T			X7R	10 μ	±10, ±20	10	150	1.25+0.15/-0.05		

▶ This catalog contains the typical specification only due to the limitation of space. When you consider the purchase of our products, please check our product specification sheets. For details of each product (characteristics graph, reliability information, precautions for use, and so on), see our website (<http://www.ty-top.com/>).

PART NUMBER

● 316TYPE (Dimension:3.2×1.6mm JIS:3216 EIA:1206)

【Temperature Characteristic BJ : X5R(−55~+85°C)】 1.6mm thickness(L)

Part number 1	Part number 2	Rated voltage [V]	Temperature characteristics	Capacitance [F]	Capacitance tolerance [%]	tan δ [%]	HTLT		Thickness*1 [mm]	Note
							Rated voltage x %			
UMK316 BJ225□L8T		50	X5R	2.2 μ	±10, ±20	10	150		1.6±0.20	
UMK316ABJ475□L8T			X5R	4.7 μ	±10, ±20	10	150		1.6±0.20	
GMK316 BJ225□L8T		35	X5R	2.2 μ	±10, ±20	10	150		1.6±0.20	
GMK316 BJ475□L8T			X5R	4.7 μ	±10, ±20	10	150		1.6±0.20	
GMK316BBJ106□L8T		25	X5R	10 μ	±10, ±20	10	150		1.6±0.30	
TMK316 BJ475□L8T			X5R	4.7 μ	±10, ±20	5	150		1.6±0.20	
TMK316 BJ106□L8T		16	X5R	10 μ	±10, ±20	5	150		1.6±0.20	
EMK316 BJ475□L8T			X5R	4.7 μ	±10, ±20	5	150		1.6±0.20	
EMK316 BJ106□L8T		10	X5R	10 μ	±10, ±20	5	150		1.6±0.20	
EMK316BBJ226ML8T			X5R	22 μ	±20	10	150		1.6±0.30	
LMK316ABJ226□L8T		6.3	X5R	22 μ	±10, ±20	10	150		1.6±0.20	
JMK316ABJ476ML8T			X5R	47 μ	±20	10	150		1.6±0.20	
JMK316BBJ107ML8T		4	X5R	100 μ	±20	10	150		1.6±0.30	
AMK316ABJ107ML8T			X5R	100 μ	±20	10	150		1.6±0.20	

【Temperature Characteristic B7 : X7R(−55~+125°C), C7 : X7S(−55~+125°C)】 1.6mm thickness(L)

Part number 1	Part number 2	Rated voltage [V]	Temperature characteristics	Capacitance [F]	Capacitance tolerance [%]	tan δ [%]	HTLT		Thickness*1 [mm]	Note
							Rated voltage x %			
UMK316 B7105□L8T		50	X7R	1 μ	±10, ±20	3.5	200		1.6±0.20	
UMK316BC7155□L8TE			X7S	1.5 μ	±10, ±20	3.5	150		1.6±0.30	
UMK316 B7225□L8T		35	X7R	2.2 μ	±10, ±20	10	150		1.6±0.20	
UMK316AC7475□L8TE			X7S	4.7 μ	±10, ±20	2.5	150		1.6±0.20	
GMK316 B7225□L8T		25	X7R	2.2 μ	±10, ±20	10	150		1.6±0.20	
GMK316AB7475□L8T			X7R	4.7 μ	±10, ±20	10	150		1.6±0.20	
TMK316AB7475□L8T		16	X7R	4.7 μ	±10, ±20	10	150		1.6±0.20	
TMK316AB7106□L8T			X7R	10 μ	±10, ±20	10	150		1.6±0.20	
EMK316AB7475□L8T		10	X7R	4.7 μ	±10, ±20	10	150		1.6±0.20	
EMK316AB7106□L8T			X7R	10 μ	±10, ±20	10	150		1.6±0.20	
LMK316AB7106□L8T		6.3	X7R	10 μ	±10, ±20	10	150		1.6±0.20	
JMK316AB7226□L8T		4	X7R	22 μ	±10, ±20	10	150		1.6±0.20	
AMK316AB7226□L8T			X7R	22 μ	±10, ±20	10	150		1.6±0.20	
AMK316AC7476ML8T			X7S	47 μ	±20	10	150		1.6±0.20	

● 325TYPE (Dimension:3.2×2.5mm JIS:3225 EIA:1210)

【Temperature Characteristic BJ : X5R(−55~+85°C)】 2.5mm thickness(M)

Part number 1	Part number 2	Rated voltage [V]	Temperature characteristics	Capacitance [F]	Capacitance tolerance [%]	tan δ [%]	HTLT		Thickness*1 [mm]	Note
							Rated voltage x %			
UMK325 BJ106□M8P		50	X5R	10 μ	±10, ±20	5	150		2.5±0.20	
EMK325ABJ476□M8P		16	X5R	47 μ	±10, ±20	10	150		2.5±0.30	
LMK325 BJ476□M8P		10	X5R	47 μ	±10, ±20	10	150		2.5±0.20	
LMK325ABJ107MM8P			X5R	100 μ	±20	10	150		2.5±0.30	
AMK325ABJ227MM8P		4	X5R	220 μ	±20	10	150		2.5±0.30	

【Temperature Characteristic C6 : X6S(−55~+105°C)】 2.5mm thickness(M)

Part number 1	Part number 2	Rated voltage [V]	Temperature characteristics	Capacitance [F]	Capacitance tolerance [%]	tan δ [%]	HTLT		Thickness*1 [mm]	Note
							Rated voltage x %			
JMK325AC6107MM8P		6.3	X6S	100 μ	±20	10	150		2.5±0.30	

【Temperature Characteristic B7 : X7R(−55~+125°C)】 2.5mm thickness(M)

Part number 1	Part number 2	Rated voltage [V]	Temperature characteristics	Capacitance [F]	Capacitance tolerance [%]	tan δ [%]	HTLT		Thickness*1 [mm]	Note
							Rated voltage x %			
UMK325 B7475□M8P		50	X7R	4.7 μ	±10, ±20	5	150		2.5±0.20	
UMK325AB7106□M8P			X7R	10 μ	±10, ±20	10	150		2.5±0.30	
GMK325AB7106□M8P		35	X7R	10 μ	±10, ±20	10	150		2.5±0.30	
TMK325AB7106□M8PR			X7R	10 μ	±10, ±20	10	150		2.5±0.30	
TMK325 B7226□M8P		25	X7R	22 μ	±10, ±20	10	150		2.5±0.20	
EMK325 B7226□M8P			X7R	22 μ	±10, ±20	10	150		2.5±0.20	
LMK325 B7226□M8P		10	X7R	22 μ	±10, ±20	10	150		2.5±0.20	
JMK325 B7476□M8PR			6.3	X7R	47 μ	±10, ±20	10	150		2.5±0.20

▶ This catalog contains the typical specification only due to the limitation of space. When you consider the purchase of our products, please check our product specification sheets. For details of each product (characteristics graph, reliability information, precautions for use, and so on), see our website (<http://www.ty-top.com/>).

CERAMIC CAPACITORS
 INDL
 For Telecommunications Infrastructure and Industrial Equipment / Medical Devices
 MULTILAYER CERAMIC CAPACITORS(HIGH DIELECTRIC TYPE)

Multilayer Ceramic Capacitors

PACKAGING

① Minimum Quantity

● Taped package

Type(EIA)	Thickness		Standard quantity [pcs]	
	mm	code	Paper tape	Embossed tape
<input type="checkbox"/> MK021(008004)	0.125	K	—	50000
<input type="checkbox"/> VS021(008004)				
<input type="checkbox"/> MK042(01005)	0.2	C, D	—	40000
<input type="checkbox"/> VS042(01005)				
<input type="checkbox"/> MK063(0201)	0.3	P, T	15000	—
<input type="checkbox"/> WK105(0204) ※	0.3	P	10000	—
<input type="checkbox"/> MK105(0402) <input type="checkbox"/> MF105(0402)	0.13	H	—	20000
	0.18	E	—	15000
	0.2	C	20000	—
	0.3	P	15000	—
	0.5	V	10000	—
<input type="checkbox"/> VK105(0402)	0.5	W	10000	—
<input type="checkbox"/> MK107(0603)	0.45	K	4000	—
<input type="checkbox"/> WK107(0306) ※	0.5	V	—	4000
<input type="checkbox"/> MF107(0603)	0.8	A	4000	—
<input type="checkbox"/> VS107(0603)	0.7	C	4000	—
<input type="checkbox"/> MJ107(0603)	0.8	A	3000	3000
<input type="checkbox"/> MK212(0805)	0.45	K	4000	—
<input type="checkbox"/> WK212(0508) ※	0.85	D		
<input type="checkbox"/> MF212(0805)	1.25	G	—	3000
<input type="checkbox"/> VS212(0805)	0.85	D	4000	—
<input type="checkbox"/> MJ212(0805)	0.85	D	4000	—
	1.25	G	—	2000
<input type="checkbox"/> MK316(1206) <input type="checkbox"/> MF316(1206)	0.85	D	4000	—
	1.15	F	—	3000
	1.6	L	—	2000
<input type="checkbox"/> MJ316(1206)	1.15	F	—	3000
	1.6	L	—	2000
<input type="checkbox"/> MK325(1210) <input type="checkbox"/> MF325(1210)	0.85	D	—	2000
	1.15	F		
	1.9	N		
	2.0max.	Y		
<input type="checkbox"/> MJ325(1210)	2.5	M	—	1000
	1.9	N	—	2000
<input type="checkbox"/> MK432(1812)	2.5	M	—	500(T), 1000(P)
	2.5	M	—	500

Note : ※ LW Reverse type.

② Taping material

※No bottom tape for pressed carrier tape

● Card board carrier tape

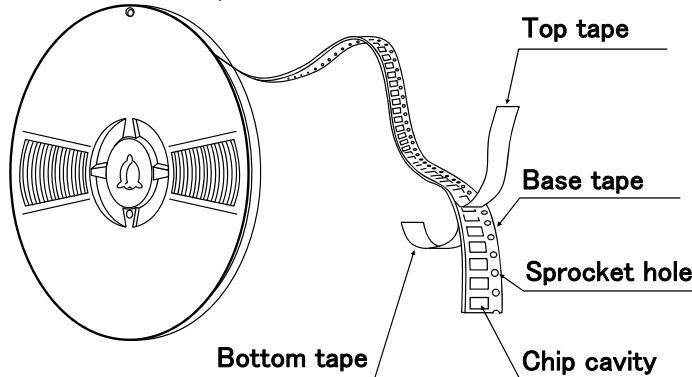

● Embossed tape

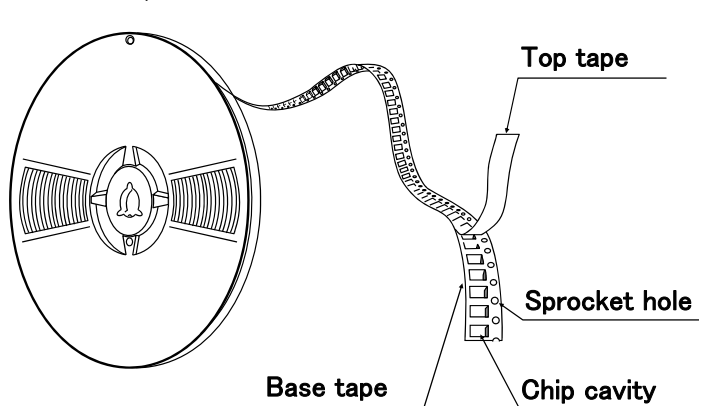

▶ This catalog contains the typical specification only due to the limitation of space. When you consider the purchase of our products, please check our specification. For details of each product (characteristics graph, reliability information, precautions for use, and so on), see our Web site (<http://www.ty-top.com/>).



③ Representative taping dimensions

● Paper Tape (8mm wide)

● Pressed carrier tape (2mm pitch)

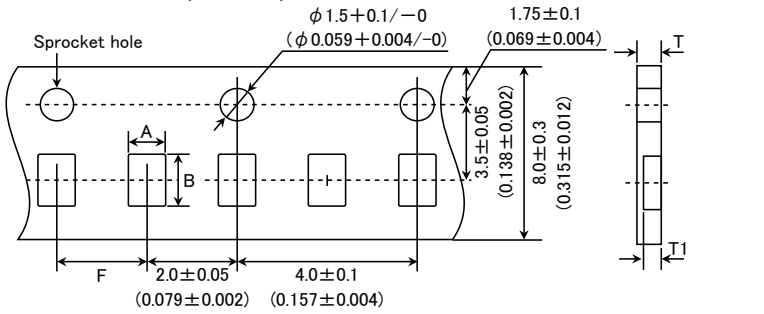

Type(EIA)	Chip Cavity		Insertion Pitch F	Tape Thickness	
	A	B		T	T1
□MK063(0201)	0.37	0.67	2.0±0.05	0.45max.	0.42max.
□WK105(0204) ※	0.65	1.15		0.4max.	0.3max.
□MK105(0402) (*1 C)				0.45max.	0.42max.
□MK105(0402) (*1 P)					

Note *1 Thickness, C: 0.2mm ,P: 0.3mm. ※ LW Reverse type.

Unit: mm

● Punched carrier tape (2mm pitch)



Type(EIA)	Chip Cavity		Insertion Pitch F	Tape Thickness
	A	B		T
□MK105 (0402)	0.65	1.15	2.0±0.05	0.8max.
□MF105 (0402)				
□VK105 (0402)				

Unit: mm

● Punched carrier tape (4mm pitch)



▶ This catalog contains the typical specification only due to the limitation of space. When you consider the purchase of our products, please check our specification. For details of each product (characteristics graph, reliability information, precautions for use, and so on), see our Web site (<http://www.ty-top.com/>).

Type(EIA)	Chip Cavity		Insertion Pitch	Tape Thickness
	A	B		
□MK107(0603) □WK107(0306) ※ □MF107(0603)	1.0	1.8	4.0±0.1	1.1max.
□MK212(0805) □WK212(0508) ※	1.65	2.4		1.1max.
□MK316(1206)	2.0	3.6		

Note: Taping size might be different depending on the size of the product. ※ LW Reverse type. Unit: mm

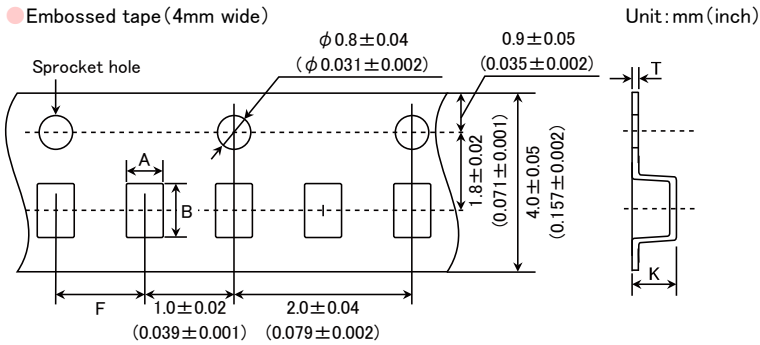

Type(EIA)	Chip Cavity		Insertion Pitch	Tape Thickness	
	A	B		K	T
□MK021(008004) □VS021(008004)	0.135	0.27	1.0±0.02	0.5max.	0.25max.
□MK042(01005) □VS042(01005)					

Unit: mm

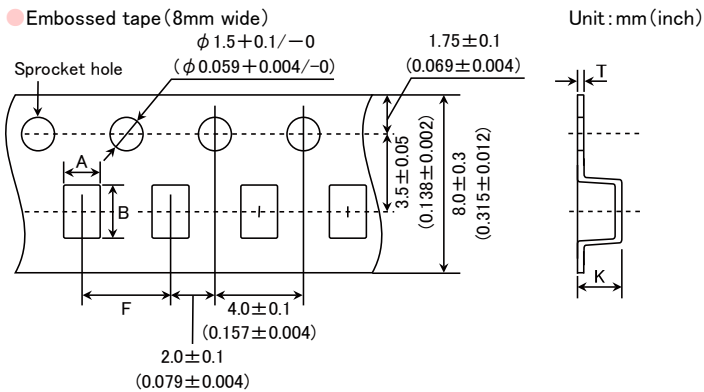

Type(EIA)	Chip Cavity		Insertion Pitch	Tape Thickness	
	A	B		K	T
□MK105(0402)	0.6	1.1	2.0±0.1	0.6max	0.2±0.1
□WK107(0306) ※ □MK212(0805) □MF212(0805)	1.0	1.8	4.0±0.1	1.3max.	0.25±0.1
□MK316(1206) □MF316(1206)	2.0	3.6		3.4max.	0.6max.
□MK325(1210) □MF325(1210)	2.8	3.6			

Note: ※ LW Reverse type.

Unit: mm



Type(EIA)	Chip Cavity		Insertion Pitch	Tape Thickness	
	A	B	F	K	T
□MK325(1210)	3.1	4.0	8.0±0.1	4.0max.	0.6max.
□MK432(1812)	3.7	4.9	8.0±0.1	4.0max.	0.6max.

Unit: mm

④Trailer and Leader



⑤Reel size



A	B	C	D	E	R
$\phi 178 \pm 2.0$	$\phi 50 \text{min.}$	$\phi 13.0 \pm 0.2$	$\phi 21.0 \pm 0.8$	2.0 ± 0.5	1.0

	T	W
4mm wide tape	1.5max.	5 ± 1.0
8mm wide tape	2.5max.	10 ± 1.5
12mm wide tape	2.5max.	14 ± 1.5

Unit: mm

⑥Top Tape Strength

The top tape requires a peel-off force of 0.1 to 0.7N in the direction of the arrow as illustrated below.

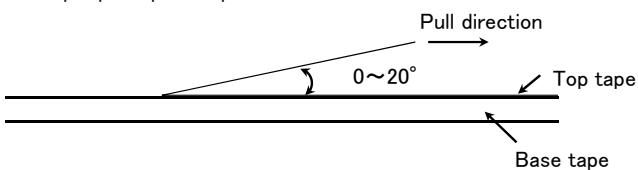

▶ This catalog contains the typical specification only due to the limitation of space. When you consider the purchase of our products, please check our specification. For details of each product (characteristics graph, reliability information, precautions for use, and so on), see our Web site (<http://www.ty-top.com/>).

Multilayer Ceramic Capacitors

RELIABILITY DATA

1. Operating Temperature Range

Specified Value	Temperature Compensating(Class1)	Standard	-55 to +125°C	
		High Frequency Type		
Specified Value	High Permittivity (Class2)		Specification	Temperature Range
		BJ	B	-25 to +85°C
			X5R	-55 to +85°C
		B7	X7R	-55 to +125°C
		C6	X6S	-55 to +105°C
		C7	X7S	-55 to +125°C
		D7	X7T	-55 to +125°C
		LD(※)	X5R	-55 to +85°C
Note: ※LD Low distortion high value multilayer ceramic capacitor				

2. Storage Conditions

Specified Value	Temperature Compensating(Class1)	Standard	-55 to +125°C	
		High Frequency Type		
Specified Value	High Permittivity (Class2)		Specification	Temperature Range
		BJ	B	-25 to +85°C
			X5R	-55 to +85°C
		B7	X7R	-55 to +125°C
		C6	X6S	-55 to +105°C
		C7	X7S	-55 to +125°C
		D7	X7T	-55 to +125°C
		LD(※)	X5R	-55 to +85°C
Note: ※LD Low distortion high value multilayer ceramic capacitor				

3. Rated Voltage

Specified Value	Temperature Compensating(Class1)	Standard	50VDC, 25VDC
		High Frequency Type	50VDC, 25VDC
	High Permittivity (Class2)		50VDC, 35VDC, 25VDC, 16VDC, 10VDC, 6.3VDC, 4VDC, 2.5VDC

4. Withstanding Voltage (Between terminals)

Specified Value	Temperature Compensating(Class1)	Standard	No breakdown or damage
		High Frequency Type	
Test Methods and Remarks	High Permittivity (Class2)		
		Class 1	Class 2
	Applied voltage	Rated volta × 3	Rated voltage × 2.5
	Duration	1 to 5 sec.	
Charge/discharge current	50mA max.		

5. Insulation Resistance

Specified Value	Temperature Compensating(Class1)	Standard	10000 MΩ min.
		High Frequency Type	
Specified Value	High Permittivity (Class2) Note 1		C ≤ 0.047 μF : 10000 MΩ min. C > 0.047 μF : 500MΩ · μF
	Test Methods and Remarks	Applied voltage	: Rated voltage
	Duration	: 60 ± 5 sec.	
	Charge/discharge current	: 50mA max.	

▶ This catalog contains the typical specification only due to the limitation of space. When you consider the purchase of our products, please check our specification. For details of each product (characteristics graph, reliability information, precautions for use, and so on), see our Web site (<http://www.ty-top.com/>).

6. Capacitance (Tolerance)				
Specified Value	Temperature Compensating(Class1)	Standard	C□	0.2pF ≤ C ≤ 5pF : ±0.25pF
			U□	0.2pF ≤ C ≤ 10pF : ±0.5pF
	SL	C > 10pF : ±5% or ±10%		
High Permittivity (Class2)	High Frequency Type	CH	0.3pF ≤ C ≤ 2pF : ±0.1pF	C > 2pF : ±5%
	BJ, B7, C6, C7, D7, LD(※) : ±10% or ±20% Note: ※LD Low distortion high value multilayer ceramic capacitor			

Test Methods and Remarks	Class 1		Class 2		
	Standard	High Frequency Type	C ≤ 10 μF	C > 10 μF	
	Preconditioning		None		
	Measuring frequency		Thermal treatment (at 150°C for 1hr) Note 2		
	Measuring voltage Note		1MHz ± 10%		
Bias application		0.5 to 5Vrms			

7. Q or Dissipation Factor				
Specified Value	Temperature Compensating(Class1)	Standard	C < 30pF : Q ≥ 400 + 20C C ≥ 30pF : Q ≥ 1000 (C : Nominal capacitance)	
		High Frequency Type	Refer to detailed specification	
High Permittivity (Class2) Note 1		BJ, B7, C6, C7, D7: 2.5% max.		

Test Methods and Remarks	Class 1		Class 2		
	Standard	High Frequency Type	C ≤ 10 μF	C > 10 μF	
	Preconditioning		None		
	Measuring frequency		Thermal treatment (at 150°C for 1hr) Note 2		
	Measuring voltage Note 1		1MHz ± 10%		
Bias application		0.5 to 5Vrms			

High Frequency Type
Measuring equipment : HP4291A
Measuring jig : HP16192A

8. Temperature Characteristic (Without voltage application)																																										
Specified Value	Temperature Compensating(Class1)	Standard	Temperature Characteristic [ppm/°C]		Tolerance [ppm/°C]																																					
			C□ : 0	CG, CH, C, J, CK	G : ±30 H : ±60 J : ±120 K : ±250																																					
			U□ : -750	UJ, UK																																						
High Permittivity (Class2)	High Frequency Type	CH	Temperature Characteristic [ppm/°C]		Tolerance [ppm/°C]																																					
			C□ : 0	CH	H : ±60																																					
			<table border="1"> <thead> <tr> <th></th> <th>Specification</th> <th>Capacitance change</th> <th>Reference temperature</th> <th>Temperature Range</th> </tr> </thead> <tbody> <tr> <td rowspan="2">BJ</td> <td>B</td> <td>±10%</td> <td>20°C</td> <td>-25 to +85°C</td> </tr> <tr> <td>X5R</td> <td>±15%</td> <td>25°C</td> <td>-55 to +85°C</td> </tr> <tr> <td>B7</td> <td>X7R</td> <td>±15%</td> <td>25°C</td> <td>-55 to +125°C</td> </tr> <tr> <td>C6</td> <td>X6S</td> <td>±22%</td> <td>25°C</td> <td>-55 to +105°C</td> </tr> <tr> <td>C7</td> <td>X7S</td> <td>±22%</td> <td>25°C</td> <td>-55 to +125°C</td> </tr> <tr> <td>D7</td> <td>X7S</td> <td>+22/-33%</td> <td>25°C</td> <td>-55 to +125°C</td> </tr> <tr> <td>LD(※)</td> <td>X5R</td> <td>±15%</td> <td>25°C</td> <td>-55 to +85°C</td> </tr> </tbody> </table>					Specification	Capacitance change	Reference temperature	Temperature Range	BJ	B	±10%	20°C	-25 to +85°C	X5R	±15%	25°C	-55 to +85°C	B7	X7R	±15%	25°C	-55 to +125°C	C6	X6S	±22%	25°C	-55 to +105°C	C7	X7S	±22%	25°C	-55 to +125°C	D7	X7S	+22/-33%	25°C	-55 to +125°C	LD(※)	X5R
	Specification	Capacitance change	Reference temperature	Temperature Range																																						
BJ	B	±10%	20°C	-25 to +85°C																																						
	X5R	±15%	25°C	-55 to +85°C																																						
B7	X7R	±15%	25°C	-55 to +125°C																																						
C6	X6S	±22%	25°C	-55 to +105°C																																						
C7	X7S	±22%	25°C	-55 to +125°C																																						
D7	X7S	+22/-33%	25°C	-55 to +125°C																																						
LD(※)	X5R	±15%	25°C	-55 to +85°C																																						
Note : ※LD Low distortion high value multilayer ceramic capacitor																																										

Test Methods and Remarks	Class 1 : Capacitance at 20°C and 85°C shall be measured in thermal equilibrium, and the temperature characteristic shall be calculated from the following equation.			
	$\frac{(C_{85} - C_{20})}{C_{20} \times \Delta T} \times 10^6 (\text{ppm}/^\circ\text{C}) \quad \Delta T = 65$			
	Class 2 : Capacitance at each step shall be measured in thermal equilibrium, and the temperature characteristic shall be calculated from the following equation.			
	Step	B	X5R, X7R, X6S, X7S, X7T	
	1	Minimum operating temperature		
2	20°C	25°C		
3	Maximum operating temperature			
$\frac{(C - C_2)}{C_2} \times 100 (\%)$				
C : Capacitance in Step 1 or Step 3				
C2 : Capacitance in Step 2				

▶ This catalog contains the typical specification only due to the limitation of space. When you consider the purchase of our products, please check our specification. For details of each product (characteristics graph, reliability information, precautions for use, and so on), see our Web site (<http://www.ty-top.com/>).

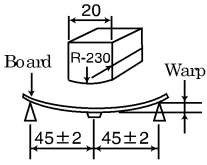
9. Deflection																				
Specified Value	Temperature Compensating(Class1)	Standard	Appearance : No abnormality Capacitance change : Within $\pm 5\%$ or ± 0.5 pF, whichever is larger.																	
		High Frequency Type	Appearance : No abnormality Capacitance change : Within ± 0.5 pF																	
	High Permittivity (Class2)		Appearance : No abnormality Capacitance change : Within $\pm 12.5\%$ (BJ, B7, C6, C7, D7, LD(※)) Note: ※LD Low distortion high value multilayer ceramic capacitor																	
Test Methods and Remarks	<table border="1"> <thead> <tr> <th rowspan="2"></th> <th colspan="2">Multilayer Ceramic Capacitors</th> </tr> <tr> <th>042, 063, ※1105 Type</th> <th>The other types</th> </tr> </thead> <tbody> <tr> <td>Board</td> <td colspan="2">Glass epoxy-resin substrate</td> </tr> <tr> <td>Thickness</td> <td>0.8mm</td> <td>1.6mm</td> </tr> <tr> <td>Warp</td> <td colspan="2">1mm (Soft Termination type:3mm)</td> </tr> <tr> <td>Duration</td> <td colspan="2">10 sec.</td> </tr> </tbody> </table>			Multilayer Ceramic Capacitors		042, 063, ※1105 Type	The other types	Board	Glass epoxy-resin substrate		Thickness	0.8mm	1.6mm	Warp	1mm (Soft Termination type:3mm)		Duration	10 sec.		 <p>(Unit: mm) Capacitance measurement shall be conducted with the board bent</p>
		Multilayer Ceramic Capacitors																		
042, 063, ※1105 Type		The other types																		
Board	Glass epoxy-resin substrate																			
Thickness	0.8mm	1.6mm																		
Warp	1mm (Soft Termination type:3mm)																			
Duration	10 sec.																			
※1:105 Type thickness, C: 0.2mm, P: 0.3mm.																				

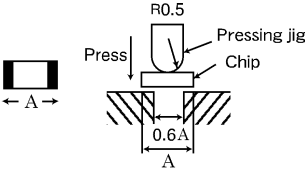
10. Body Strength			
Specified Value	Temperature Compensating(Class1)	Standard	—
		High Frequency Type	No mechanical damage.
	High Permittivity (Class2)		—
Test Methods and Remarks	High Frequency Type Applied force : 5N Duration : 10 sec.		

11. Adhesive Strength of Terminal Electrodes														
Specified Value	Temperature Compensating(Class1)	Standard	No terminal separation or its indication.											
		High Frequency Type												
	High Permittivity (Class2)													
Test Methods and Remarks	<table border="1"> <thead> <tr> <th rowspan="2"></th> <th colspan="2">Multilayer Ceramic Capacitors</th> </tr> <tr> <th>042, 063 Type</th> <th>105 Type or more</th> </tr> </thead> <tbody> <tr> <td>Applied force</td> <td>2N</td> <td>5N</td> </tr> <tr> <td>Duration</td> <td colspan="2">30±5 sec.</td> </tr> </tbody> </table>			Multilayer Ceramic Capacitors		042, 063 Type	105 Type or more	Applied force	2N	5N	Duration	30±5 sec.		
		Multilayer Ceramic Capacitors												
		042, 063 Type	105 Type or more											
Applied force	2N	5N												
Duration	30±5 sec.													

12. Solderability															
Specified Value	Temperature Compensating(Class1)	Standard	At least 95% of terminal electrode is covered by new solder.												
		High Frequency Type													
	High Permittivity (Class2)														
Test Methods and Remarks	<table border="1"> <thead> <tr> <th rowspan="2"></th> <th>Eutectic solder</th> <th>Lead-free solder</th> </tr> </thead> <tbody> <tr> <td>Solder type</td> <td>H60A or H63A</td> <td>Sn-3.0Ag-0.5Cu</td> </tr> <tr> <td>Solder temperature</td> <td>230±5°C</td> <td>245±3°C</td> </tr> <tr> <td>Duration</td> <td colspan="2">4±1 sec.</td> </tr> </tbody> </table>			Eutectic solder	Lead-free solder	Solder type	H60A or H63A	Sn-3.0Ag-0.5Cu	Solder temperature	230±5°C	245±3°C	Duration	4±1 sec.		
		Eutectic solder		Lead-free solder											
		Solder type	H60A or H63A	Sn-3.0Ag-0.5Cu											
	Solder temperature	230±5°C	245±3°C												
Duration	4±1 sec.														

▶ This catalog contains the typical specification only due to the limitation of space. When you consider the purchase of our products, please check our specification. For details of each product (characteristics graph, reliability information, precautions for use, and so on), see our Web site (<http://www.ty-top.com/>).

13. Resistance to Soldering

Specified Value	Temperature Compensating(Class1)	Standard	Appearance : No abnormality Capacitance change : Within $\pm 2.5\%$ or $\pm 0.25\text{pF}$, whichever is larger. Q : Initial value Insulation resistance : Initial value Withstanding voltage (between terminals) : No abnormality
		High Frequency Type	Appearance : No abnormality Capacitance change : Within $\pm 2.5\%$ Q : Initial value Insulation resistance : Initial value Withstanding voltage (between terminals) : No abnormality
	High Permittivity (Class2) Note 1		Appearance : No abnormality Capacitance change : Within $\pm 7.5\%$ (BJ, B7, C6, C7, D7, LD(※)) Dissipation factor : Initial value Insulation resistance : Initial value Withstanding voltage (between terminals): No abnormality Note: ※LD Low distortion high value multilayer ceramic capacitor

Test Methods and Remarks	Class 1			
		042, 063 Type	105 Type	
	Preconditioning	None		
	Preheating	150°C, 1 to 2 min.	80 to 100°C, 2 to 5 min. 150 to 200°C, 2 to 5 min.	
	Solder temp.	270 \pm 5°C		
	Duration	3 \pm 0.5 sec.		
	Recovery	6 to 24 hrs (Standard condition) Note 5		
	Class 2			
		042, 063 Type	105, 107, 212 Type	316, 325 Type
	Preconditioning	Thermal treatment (at 150°C for 1 hr) Note 2		
	Preheating	150°C, 1 to 2 min.	80 to 100°C, 2 to 5 min. 150 to 200°C, 2 to 5 min.	80 to 100°C, 5 to 10 min. 150 to 200°C, 5 to 10 min.
	Solder temp.	270 \pm 5°C		
	Duration	3 \pm 0.5 sec.		
	Recovery	24 \pm 2 hrs (Standard condition) Note 5		

14. Temperature Cycle (Thermal Shock)

Specified Value	Temperature Compensating(Class1)	Standard	Appearance : No abnormality Capacitance change : Within $\pm 2.5\%$ or $\pm 0.25\text{pF}$, whichever is larger. Q : Initial value Insulation resistance : Initial value Withstanding voltage (between terminals) : No abnormality
		High Frequency Type	Appearance : No abnormality Capacitance change : Within $\pm 0.25\text{pF}$ Q : Initial value Insulation resistance : Initial value Withstanding voltage (between terminals) : No abnormality
	High Permittivity (Class2) Note 1		Appearance : No abnormality Capacitance change : Within $\pm 7.5\%$ (BJ, B7, C6, C7, D7, LD(※)) Dissipation factor : Initial value Insulation resistance : Initial value Withstanding voltage (between terminals) : No abnormality Note: ※LD Low distortion high value multilayer ceramic capacitor

Test Methods and Remarks	Class 1		Class 2	
	Preconditioning	None	Thermal treatment (at 150°C for 1 hr) Note 2	
	1 cycle	Step	Temperature (°C)	Time (min.)
		1	Minimum operating temperature	30 \pm 3
		2	Normal temperature	2 to 3
		3	Maximum operating temperature	30 \pm 3
4	Normal temperature	2 to 3		
Number of cycles	5 times			
Recovery	6 to 24 hrs (Standard condition) Note 5	24 \pm 2 hrs (Standard condition) Note 5		

▶ This catalog contains the typical specification only due to the limitation of space. When you consider the purchase of our products, please check our specification.
 For details of each product (characteristics graph, reliability information, precautions for use, and so on), see our Web site (<http://www.ty-top.com/>).

15. Humidity (Steady State)					
Specified Value	Temperature Compensating(Class1)	Standard	Appearance : No abnormality Capacitance change : Within $\pm 5\%$ or $\pm 0.5\text{pF}$, whichever is larger. Q : $C < 10\text{pF} : Q \geq 200 + 10C$ $10 \leq C < 30\text{pF} : Q \geq 275 + 2.5C$ $C \geq 30\text{pF} : Q \geq 350$ (C: Nominal capacitance) Insulation resistance : 1000 M Ω min.		
		High Frequency Type	Appearance : No abnormality Capacitance change : Within $\pm 0.5\text{pF}$, Insulation resistance : 1000 M Ω min.		
	High Permittivity (Class2) Note 1		Appearance : No abnormality Capacitance change : Within $\pm 12.5\%$ (BJ, B7, C6, C7, D7, LD(※)) Dissipation factor : 5.0% max. (BJ, B7, C6, C7, D7, LD(※)) Insulation resistance : 50 M Ω μF or 1000 M Ω whichever is smaller. Note: ※LD Low distortion high value multilayer ceramic capacitor		
Test Methods and Remarks		Class 1		Class 2	
		Standard	High Frequency Type	All items	
	Preconditioning	None			Thermal treatment (at 150°C for 1 hr) Note 2
	Temperature	40 \pm 2°C	60 \pm 2°C	40 \pm 2°C	
	Humidity	90 to 95%RH		90 to 95%RH	
	Duration	500+24/-0 hrs		500+24/-0 hrs	
	Recovery	6 to 24 hrs (Standard condition) Note 5		24 \pm 2 hrs (Standard condition) Note 5	

16. Humidity Loading					
Specified Value	Temperature Compensating(Class1)	Standard	Appearance : No abnormality Capacitance change : Within $\pm 7.5\%$ or $\pm 0.75\text{pF}$, whichever is larger. Q : $C < 30\text{pF} : Q \geq 100 + 10C/3$ $C \geq 30\text{pF} : Q \geq 200$ (C: Nominal capacitance) Insulation resistance : 500 M Ω min.		
		High Frequency Type	Appearance : No abnormality Capacitance change : $C \leq 2\text{pF} : \text{Within } \pm 0.4 \text{ pF}$ $C > 2\text{pF} : \text{Within } \pm 0.75 \text{ pF}$ (C: Nominal capacitance) Insulation resistance : 500 M Ω min.		
	High Permittivity (Class2) Note 1		Appearance : No abnormality Capacitance change : Within $\pm 12.5\%$ (BJ, B7, C6, C7, D7, LD(※)) Dissipation factor : 5.0% max. (BJ, B7, C6, C7, D7, LD(※)) Insulation resistance : 25 M Ω μF or 500 M Ω , whichever is smaller. Note: ※LD Low distortion high value multilayer ceramic capacitor		
Test Methods and Remarks		Class 1		Class 2	
		Standard	High Frequency Type	All items	
	Preconditioning	None			Voltage treatment (Rated voltage are applied for 1 hour at 40°C) Note 3
	Temperature	40 \pm 2°C	60 \pm 2°C	40 \pm 2°C	
	Humidity	90 to 95%RH		90 to 95%RH	
	Duration	500+24/-0 hrs		500+24/-0 hrs	
	Applied voltage	Rated voltage		Rated voltage	
	Charge/discharge current	50mA max.		50mA max.	
Recovery	6 to 24 hrs (Standard condition) Note 5		24 \pm 2 hrs (Standard condition) Note 5		

17. High Temperature Loading

► This catalog contains the typical specification only due to the limitation of space. When you consider the purchase of our products, please check our specification.
For details of each product (characteristics graph, reliability information, precautions for use, and so on), see our Web site (<http://www.ty-top.com/>).

Specified Value	Temperature Compensating(Class1)	Standard	Appearance : No abnormality Capacitance change : Within $\pm 3\%$ or $\pm 0.3\text{pF}$, whichever is larger. Q : $C < 10\text{pF}$: $Q \geq 200 + 10C$ $10 \leq C < 30\text{pF}$: $Q \geq 275 + 2.5C$ $C \geq 30\text{pF}$: $Q \geq 350$ (C: Nominal capacitance) Insulation resistance : $1000 \text{ M}\Omega$ min.
		High Frequency Type	Appearance : No abnormality Capacitance change : Within $\pm 3\%$ or $\pm 0.3\text{pF}$, whichever is larger. Insulation resistance : $1000 \text{ M}\Omega$ min.
	High Permittivity (Class2) Note 1		Appearance : No abnormality Capacitance change : Within $\pm 12.5\%$ (BJ, B7, C6, C7, D7, LD(※)) Dissipation factor : 5.0% max. (BJ, B7, C6, C7, D7, LD(※)) Insulation resistance : $50 \text{ M}\Omega \mu\text{F}$ or $1000 \text{ M}\Omega$, whichever is smaller. Note: ※LD Low distortion high value multilayer ceramic capacitor

Test Methods and Remarks		Class 1		Class 2		
		Standard	High Frequency Type	BJ, LD(※)	C6	B7, C7, D7
	Preconditioning	None		Voltage treatment (Twice the rated voltage shall be applied for 1 hour at 85°C, 105°C or 125°C) Note 3, 4		
	Temperature	Maximum operating temperature		Maximum operating temperature		
	Duration	1000+48/-0 hrs		1000+48/-0 hrs		
	Applied voltage	Rated voltage $\times 2$		Rated voltage $\times 2$ Note 4		
	Charge/discharge current	50mA max.		50mA max.		
	Recovery	6 to 24hr (Standard condition) Note 5		24 \pm 2 hrs (Standard condition) Note 5		
Note: ※LD Low distortion high value multilayer ceramic capacitor						

Note 1 The figures indicate typical specifications. Please refer to individual specifications in detail.

Note 2 Thermal treatment : Initial value shall be measured after test sample is heat-treated at $150 \pm 0 / -10^\circ\text{C}$ for an hour and kept at room temperature for 24 ± 2 hours.

Note 3 Voltage treatment : Initial value shall be measured after test sample is voltage-treated for an hour at both the temperature and voltage specified in the test conditions, and kept at room temperature for 24 ± 2 hours.

Note 4 150% of rated voltage is applicable to some items. Please refer to their specifications for further information.

Note 5 Standard condition: Temperature: 5 to 35°C, Relative humidity: 45 to 85 % RH, Air pressure: 86 to 106kPa When there are questions concerning measurement results, in order to provide correlation data, the test shall be conducted under the following condition.

Temperature: $20 \pm 2^\circ\text{C}$, Relative humidity: 60 to 70 % RH, Air pressure: 86 to 106kPa Unless otherwise specified, all the tests are conducted under the "standard condition".

Precautions on the use of Multilayer Ceramic Capacitors

PRECAUTIONS

1. Circuit Design

Precautions

- ◆ Verification of operating environment, electrical rating and performance
 1. A malfunction of equipment in fields such as medical, aerospace, nuclear control, etc. may cause serious harm to human life or have severe social ramifications. Therefore, any capacitors to be used in such equipment may require higher safety and reliability, and shall be clearly differentiated from them used in general purpose applications.
- ◆ Operating Voltage (Verification of Rated voltage)
 1. The operating voltage for capacitors must always be their rated voltage or less.
 - If an AC voltage is loaded on a DC voltage, the sum of the two peak voltages shall be the rated voltage or less.
 - For a circuit where an AC or a pulse voltage may be used, the sum of their peak voltages shall also be the rated voltage or less.
 2. Even if an applied voltage is the rated voltage or less reliability of capacitors may be deteriorated in case that either a high frequency AC voltage or a pulse voltage having rapid rise time is used in a circuit.

2. PCB Design

Precautions

- ◆ Pattern configurations (Design of Land-patterns)
 1. When capacitors are mounted on PCBs, the amount of solder used (size of fillet) can directly affect the capacitor performance. Therefore, the following items must be carefully considered in the design of land patterns:
 - (1) Excessive solder applied can cause mechanical stresses which lead to chip breaking or cracking. Therefore, please consider appropriate land-patterns for proper amount of solder.
 - (2) When more than one component are jointly soldered onto the same land, each component's soldering point shall be separated by solder-resist.
- ◆ Pattern configurations (Capacitor layout on PCBs)

After capacitors are mounted on boards, they can be subjected to mechanical stresses in subsequent manufacturing processes (PCB cutting, board inspection, mounting of additional parts, assembly into the chassis, wave soldering of the boards, etc.). For this reason, land pattern configurations and positions of capacitors shall be carefully considered to minimize stresses.

Technical considerations

- ◆ Pattern configurations (Design of Land-patterns)

The following diagrams and tables show some examples of recommended land patterns to prevent excessive solder amounts.

(1) Recommended land dimensions for typical chip capacitors

- Multilayer Ceramic Capacitors : Recommended land dimensions (unit: mm)

Wave-soldering

Type	107	212	316	325	
Size	L	1.6	2.0	3.2	3.2
	W	0.8	1.25	1.6	2.5
A	0.8 to 1.0	1.0 to 1.4	1.8 to 2.5	1.8 to 2.5	
B	0.5 to 0.8	0.8 to 1.5	0.8 to 1.7	0.8 to 1.7	
C	0.6 to 0.8	0.9 to 1.2	1.2 to 1.6	1.8 to 2.5	

Reflow-soldering

Type	042	063	105	107	212	316	325	432
Size	L	0.4	0.6	1.0	1.6	2.0	3.2	4.5
	W	0.2	0.3	0.5	0.8	1.25	1.6	3.2
A	0.15 to 0.25	0.20 to 0.30	0.45 to 0.55	0.8 to 1.0	0.8 to 1.2	1.8 to 2.5	1.8 to 2.5	2.5 to 3.5
B	0.15 to 0.20	0.20 to 0.30	0.40 to 0.50	0.6 to 0.8	0.8 to 1.2	1.0 to 1.5	1.0 to 1.5	1.5 to 1.8
C	0.15 to 0.30	0.25 to 0.40	0.45 to 0.55	0.6 to 0.8	0.9 to 1.6	1.2 to 2.0	1.8 to 3.2	2.3 to 3.5

Note: Recommended land size might be different according to the allowance of the size of the product.

- LWDC: Recommended land dimensions for reflow-soldering (unit: mm)

Type	105	107	212	
Size	L	0.52	0.8	1.25
	W	1.0	1.6	2.0
A	0.18 to 0.22	0.25 to 0.3	0.5 to 0.7	
B	0.2 to 0.25	0.3 to 0.4	0.4 to 0.5	
C	0.9 to 1.1	1.5 to 1.7	1.9 to 2.1	

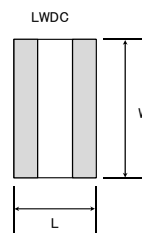
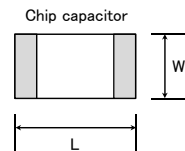

(2) Examples of good and bad solder application

Items	Not recommended	Recommended
Mixed mounting of SMD and leaded components		
Component placement close to the chassis		
Hand-soldering of leaded components near mounted components		
Horizontal component placement		

◆ Pattern configurations (Capacitor layout on PCBs)

1-1. The following is examples of good and bad capacitor layouts ; capacitors shall be located to minimize any possible mechanical stresses from board warp or deflection.

Items	Not recommended	Recommended
Deflection of board		 Place the product at a right angle to the direction of the anticipated mechanical stress.

1-2. The amount of mechanical stresses given will vary depending on capacitor layout. Please refer to diagram below.



1-3. When PCB is split, the amount of mechanical stress on the capacitors can vary according to the method used. The following methods are listed in order from least stressful to most stressful: push-back, slit, V-grooving, and perforation. Thus, please consider the PCB, split methods as well as chip location.

3. Mounting

Precautions

◆ Adjustment of mounting machine

- When capacitors are mounted on PCB, excessive impact load shall not be imposed on them.
- Maintenance and inspection of mounting machines shall be conducted periodically.

◆ Selection of Adhesives

- When chips are attached on PCBs with adhesives prior to soldering, it may cause capacitor characteristics degradation unless the following factors are appropriately checked : size of land patterns, type of adhesive, amount applied, hardening temperature and hardening period. Therefore, please contact us for further information.

◆ Adjustment of mounting machine

1. When the bottom dead center of a pick-up nozzle is too low, excessive force is imposed on capacitors and causes damages. To avoid this, the following points shall be considerable.
 - (1) The bottom dead center of the pick-up nozzle shall be adjusted to the surface level of PCB without the board deflection.
 - (2) The pressure of nozzle shall be adjusted between 1 and 3 N static loads.
 - (3) To reduce the amount of deflection of the board caused by impact of the pick-up nozzle, supporting pins or back-up pins shall be used on the other side of the PCB. The following diagrams show some typical examples of good and bad pick-up nozzle placement:

Items	Not recommended	Recommended
Single-sided mounting		
Double-sided mounting		

Technical considerations

2. As the alignment pin is worn out, adjustment of the nozzle height can cause chipping or cracking of capacitors because of mechanical impact on the capacitors. To avoid this, the monitoring of the width between the alignment pins in the stopped position, maintenance, check and replacement of the pin shall be conducted periodically.

◆ Selection of Adhesives

Some adhesives may cause IR deterioration. The different shrinkage percentage of between the adhesive and the capacitors may result in stresses on the capacitors and lead to cracking. Moreover, too little or too much adhesive applied to the board may adversely affect components. Therefore, the following precautions shall be noted in the application of adhesives.

- (1) Required adhesive characteristics
 - a. The adhesive shall be strong enough to hold parts on the board during the mounting & solder process.
 - b. The adhesive shall have sufficient strength at high temperatures.
 - c. The adhesive shall have good coating and thickness consistency.
 - d. The adhesive shall be used during its prescribed shelf life.
 - e. The adhesive shall harden rapidly.
 - f. The adhesive shall have corrosion resistance.
 - g. The adhesive shall have excellent insulation characteristics.
 - h. The adhesive shall have no emission of toxic gasses and no effect on the human body.
- (2) The recommended amount of adhesives is as follows;

[Recommended condition]

Figure	212/316 case sizes as examples
a	0.3mm min
b	100 to 120 μm
c	Adhesives shall not contact land



4. Soldering

◆ Selection of Flux

- Since flux may have a significant effect on the performance of capacitors, it is necessary to verify the following conditions prior to use;
- (1) Flux used shall be less than or equal to 0.1 wt% (in Cl equivalent) of halogenated content. Flux having a strong acidity content shall not be applied.
 - (2) When shall capacitors are soldered on boards, the amount of flux applied shall be controlled at the optimum level.
 - (3) When water-soluble flux is used, special care shall be taken to properly clean the boards.

Precautions

◆ Soldering

Temperature, time, amount of solder, etc. shall be set in accordance with their recommended conditions.
Sn-Zn solder paste can adversely affect MLCC reliability.
Please contact us prior to usage of Sn-Zn solder.

Technical considerations

◆ Selection of Flux

- 1-1. When too much halogenated substance (Chlorine, etc.) content is used to activate flux, or highly acidic flux is used, it may lead to corrosion of terminal electrodes or degradation of insulation resistance on the surfaces of the capacitors.
- 1-2. Flux is used to increase solderability in wave soldering. However if too much flux is applied, a large amount of flux gas may be emitted and may adversely affect the solderability. To minimize the amount of flux applied, it is recommended to use a flux-bubbling system.
- 1-3. Since the residue of water-soluble flux is easily dissolved in moisture in the air, the residues on the surfaces of capacitors in high humidity conditions may cause a degradation of insulation resistance and reliability of the capacitors. Therefore, the cleaning methods and the capability of the machines used shall also be considered carefully when water-soluble flux is used.

► This catalog contains the typical specification only due to the limitation of space. When you consider the purchase of our products, please check our specification. For details of each product (characteristics graph, reliability information, precautions for use, and so on), see our Web site (<http://www.ty-top.com/>).

◆Soldering

- Ceramic chip capacitors are susceptible to thermal shock when exposed to rapid or concentrated heating or rapid cooling.
- Therefore, the soldering must be conducted with great care so as to prevent malfunction of the components due to excessive thermal shock.
- Preheating : Capacitors shall be preheated sufficiently, and the temperature difference between the capacitors and solder shall be within 100 to 130°C.
- Cooling : The temperature difference between the capacitors and cleaning process shall not be greater than 100°C.

[Reflow soldering]

【Recommended conditions for eutectic soldering】



【Recommended condition for Pb-free soldering】



Caution

- ①The ideal condition is to have solder mass (fillet) controlled to 1/2 to 1/3 of the thickness of a capacitor.
- ②Because excessive dwell times can adversely affect solderability, soldering duration shall be kept as close to recommended times as possible.
- ③Allowable number of reflow soldering : 2 times max.



[Wave soldering]

【Recommended conditions for eutectic soldering】



【Recommended condition for Pb-free soldering】



Caution

- ①Wave soldering must not be applied to capacitors designated as for reflow soldering only.
- ②Allowable number of wave soldering : 1 times max.

[Hand soldering]

【Recommended conditions for eutectic soldering】



【Recommended condition for Pb-free soldering】



	ΔT
316type or less	$\Delta T \leq 150^\circ\text{C}$

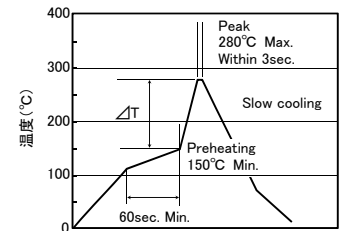

	ΔT
325type or more	$\Delta T \leq 130^\circ\text{C}$

Caution

- ①Use a 50W soldering iron with a maximum tip diameter of 1.0 mm.
- ②The soldering iron shall not directly touch capacitors.
- ③Allowable number of hand soldering : 1 times max.

5. Cleaning	
Precautions	<p>◆Cleaning conditions</p> <ol style="list-style-type: none"> When PCBs are cleaned after capacitors mounting, please select the appropriate cleaning solution in accordance with the intended use of the cleaning. (e.g. to remove soldering flux or other materials from the production process.) Cleaning condition shall be determined after it is verified by using actual cleaning machine that the cleaning process does not affect capacitor's characteristics.
Technical considerations	<ol style="list-style-type: none"> The use of inappropriate cleaning solutions can cause foreign substances such as flux residue to adhere to capacitors or deteriorate their outer coating, resulting in a degradation of the capacitor's electrical properties (especially insulation resistance). Inappropriate cleaning conditions (insufficient or excessive cleaning) may adversely affect the performance of the capacitors. In the case of ultrasonic cleaning, too much power output can cause excessive vibration of PCBs which may lead to the cracking of capacitors or the soldered portion, or decrease the terminal electrodes' strength. Therefore, the following conditions shall be carefully checked: Ultrasonic output : 20 W/l or less Ultrasonic frequency : 40 kHz or less Ultrasonic washing period : 5 min. or less

6. Resin coating and mold	
Precautions	<ol style="list-style-type: none"> With some type of resins, decomposition gas or chemical reaction vapor may remain inside the resin during the hardening period or while left under normal storage conditions resulting in the deterioration of the capacitor's performance. When a resin's hardening temperature is higher than capacitor's operating temperature, the stresses generated by the excessive heat may lead to damage or destruction of capacitors. The use of such resins, molding materials etc. is not recommended.

7. Handling	
Precautions	<p>◆Splitting of PCB</p> <ol style="list-style-type: none"> When PCBs are split after components mounting, care shall be taken so as not to give any stresses of deflection or twisting to the board. Board separation shall not be done manually, but by using the appropriate devices. <p>◆Mechanical considerations</p> <p>Be careful not to subject capacitors to excessive mechanical shocks.</p> <p>(1) If ceramic capacitors are dropped onto a floor or a hard surface, they shall not be used.</p> <p>(2) Please be careful that the mounted components do not come in contact with or bump against other boards or components.</p>

8. Storage conditions	
Precautions	<p>◆Storage</p> <ol style="list-style-type: none"> To maintain the solderability of terminal electrodes and to keep packaging materials in good condition, care must be taken to control temperature and humidity in the storage area. Humidity should especially be kept as low as possible. <ul style="list-style-type: none"> Recommended conditions <ul style="list-style-type: none"> Ambient temperature : Below 30°C Humidity : Below 70% RH The ambient temperature must be kept below 40°C. Even under ideal storage conditions, solderability of capacitor is deteriorated as time passes, so capacitors shall be used within 6 months from the time of delivery. <ul style="list-style-type: none"> Ceramic chip capacitors shall be kept where no chlorine or sulfur exists in the air. The capacitance values of high dielectric constant capacitors will gradually decrease with the passage of time, so care shall be taken to design circuits. Even if capacitance value decreases as time passes, it will get back to the initial value by a heat treatment at 150°C for 1hour.
Technical considerations	<p>If capacitors are stored in a high temperature and humidity environment, it might rapidly cause poor solderability due to terminal oxidation and quality loss of taping/packaging materials. For this reason, capacitors shall be used within 6 months from the time of delivery. If exceeding the above period, please check solderability before using the capacitors.</p>

※RCR-2335B (Safety Application Guide for fixed ceramic capacitors for use in electronic equipment) is published by JEITA.
Please check the guide regarding precautions for deflection test, soldering by spot heat, and so on.