

MDA HT Series
SMD Low Profile High Current Molded Inductor
Size 1054

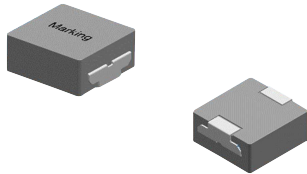

FEATURES

- Low loss realized with low DCR.
- Ultra low buzz noise, due to composite construction .
- 100% Lead(Pb)-Free and RoHS compliant.
- High performance (Isat) realized by metal dust core.
- AEC-Q200 qualified.
- Operating temperature: -55 to +165 °C (including self-temperature rise)
- Quantity: 500PCS

APPLICATION

- Headlamps, tail lamps and interior lighting
- HVAC
- Doors, window lift and seat control
- Audio subsystem
- Digital instrument cluster
- In-Vehicle Infotainment and navigation

Dimensions: [mm]

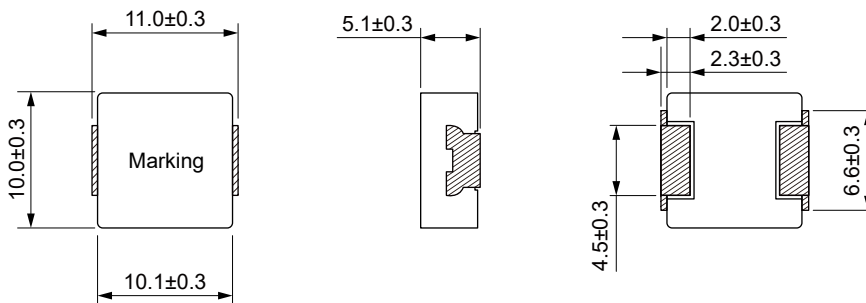

Land Pattern: [mm]

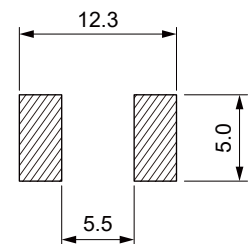

Electrical Properties:

Part No	Inductance @ 100KHz/1V (μH)	Tolerance	Temperature Rise Current Typ. (A)	Saturation Current Typ. (A)	DC Resistance Typ. (mΩ)	DC Resistance Max. (mΩ)
MDA1054HT-330M	33.0	±20%	4.80	7.60	66.0	75.3

Saturation Current will cause L to drop approximately 30%.

Temperature Rise Current: The actual value of DC current when the temperature rise is $\Delta T=40^{\circ}C$