

DMDA Series
Molded Inductor
Size 1008



FEATURES

- Low loss realized with low DCR.
- High performance realized by metal dust core.
- Ultra low buzz noise, due to composite construction.
- 100% Lead(Pb)-Free and RoHS compliant.
- High reliability -Reliability test complied to AEC-Q200
- Operating temperature: -55 to +155 °C (including self-temperature rise)
- Quantity: 400PCS

APPLICATION

- Headlamps, tail lamps and interior lighting
- HVAC
- Doors, window lift and seat control
- Audio subsystem
- Digital instrument cluster
- In-Vehicle Infotainment and navigation
- SEPIC circuit

Dimensions: [mm]

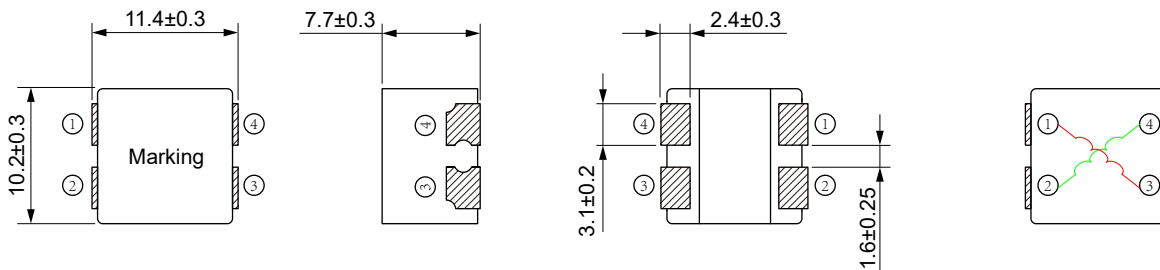

Land Pattern: [mm]

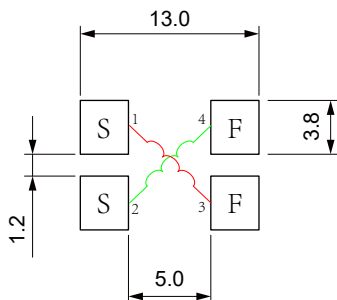

Electrical Properties:

Part No	Inductance @ 100KHz/1V (μ H) Pin1-3, Pin2-4	Tol	Temperature Rise Current Typ. (A)	Temperature Rise Current Max. (A)	Saturation Current Typ. (A)	Saturation Current Max. (A)	DC Resistance Typ. (m Ω)	DC Resistance Max. (m Ω)	K
DMDA1008-220M	22	\pm 20%	4.5	3.8	8.0	7.5	83	99.0	>0.95

Saturation Current will cause L to drop approximately 30%

Temperature Rise Current: The actual value of DC current when the temperature rise is $\Delta T=40^{\circ}\text{C}$