

◆ **Scope**

This specification applies to the SLO252010T Series of SMD power inductors.

◆ **Lead Free PartNumbering**

SLO	252010	T	1R0	M	T	T
(1)	(2)	(3)	(4)	(5)	(6)	(7)

- (1) Series Type
- (2) Dimension: LxWxH
- (3) Material Code
- (4) Inductance:R68=0.68uH;1R0=1.0μH
- (5) Inductance Tolerance:M=± 20%,N=± 30%
- (6) Company Code
- (7) Packaging: packed in embossed carrier tape

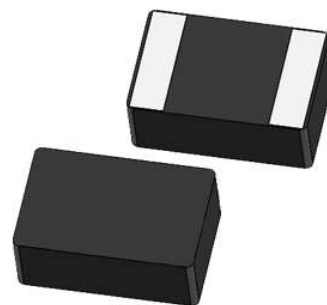

◆ **Dimensions**

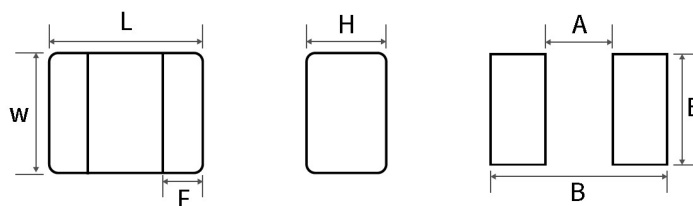

Series	L(mm)	W(mm)	H(mm)	F(mm)	Recommended Land Patterns		
					A(mm)	B(mm)	E(mm)
SLO252010T	2.5±0.2	2.0±0.2	1.0Max.	0.9Typ.	1.0Typ.	2.8Typ.	2.1Typ.

◆ **Structural drawing**

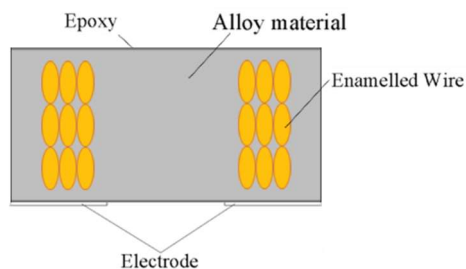

No.	Component	Material
①	Body	Alloy material
②	Winding	Enamelled Wire
③	Shield	Epoxy
④	Electric	Base plating-Cu
		Base plating-Ni
		Base plating-Sn

◆ Specification

Part No.	Inductance Ls(uH)	Direct Current Resistance DCR(mΩ)		Saturation Current Isat(A)	Temperature Rise Current Irms(A)
SLO252010TR33MTT	0.33±20%	19.0 Max	13.0 Typ	7.20 Max	6.20 Max
SLO252010TR47MTT	0.47±20%	22.0 Max	15.0 Typ	6.50 Max	5.60 Max
SLO252010TR68MTT	0.68±20%	27.0 Max	22.9 Typ	5.50 Max	5.00 Max
SLO252010T1R0MTT	1.0±20%	39.0 Max	25.7 Typ	4.80 Max	4.10 Max
SLO252010T1R5MTT	1.5±20%	55.0 Max	42.8 Typ	3.90 Max	3.00 Max
SLO252010T2R2MTT	2.2±20%	70.0 Max	62.6 Typ	3.00 Max	2.10 Max
SLO252010T3R3MTT	3.3±20%	100.0 Max	86.0 Typ	2.50 Max	2.00 Max
SLO252010T4R7MTT	4.7±20%	180.0 Max	160.0Typ	2.00 Max	1.60 Max

Test condition & equipment :

Item	Test condition	Test equipment
Ls	1MHz/1V	HP4263BIM3532-50 or equivalent
DCR	direct-current	HP4263BRM3545 or equivalent
Isat	1MH/1V	Microtest 6379 &6220 or equivalent
Irms	ambient temperature 20°C	Microtest 6379 &6220 or equivalent

Isat: The DC current at which the inductance drops approximate 30%from its value without current, Load current time within Ls.

Irms: The DC current is inductor surface temperature to rise by 40°C.

◆ Operating Temperature Range

-40°C~+125°C,Including self-heating

◆ Storage Conditions

Store products in a warehouse in compliance with the following condition:

Temperature: Inductors (product with taping) -10 to +40°C;

Inductors body -40 to +85°C.

Humidity: 30~70%RH

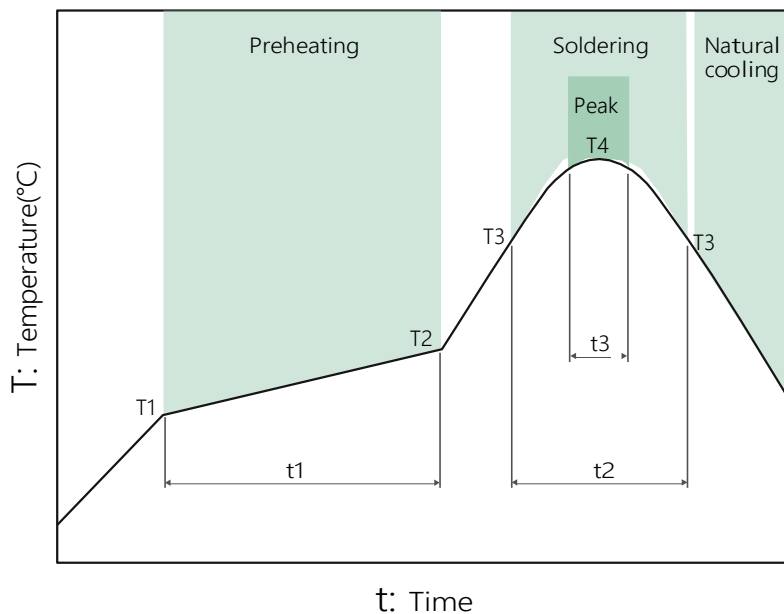
◆ RECOMMENDED REFLOW PROFILE

Preheating			Soldering		Peak	
Temp.		Time	Temp.	Time	Temp.	Time
T1	T2	t1	T3	t2	T4	t3
150°C	180°C	60 to 120s	230°C	30 to 50s	250 to 260°C	10s max

◆ Reliability Mechanical

序号 No.	项目 Items	要求 Requirements	试验方法及备注 Test Methods and Remarks
1	绝缘电阻 Insulation Resistance	$\geq 100M\Omega$	在电感器线圈和本体顶面中间施加 100 V 直流电压保持60 s。 100 V DC between inductor coil and The middle of the top surface of the body for 60 seconds.
2	可焊性 Solderability	电极面90%以上覆盖新的焊料。 90% or more of electrode area shall be coated by new solder.	在(245±5) °C熔融的焊锡 (96.5Sn/3.0Ag/0.5Cu) 中浸(5±1) s。 Dip pads in flux and dip in solder pot (96.5Sn/3.0Ag/0.5Cu) at (245±5) °C for (5±1) seconds.
3	耐焊接热 Resistance to Soldering Heat	外观无可见机械损伤; 电感量变化率: ±10%以内。 No visible mechanical damage. Inductance change: Within ±10%	在(260±5) °C熔融的焊锡 (96.5Sn/3.0Ag/0.5Cu) 中浸(10±1) s。 Dip pads in flux and dip in solder pot (96.5Sn/3.0Ag/0.5Cu) at (260±5) °C for (10±1) seconds.
4	端子强度 Adhesion of terminal electrode	元件的端子与本体结合无松动、无脱落。 Strong bond between the pad and the core, without come off PC board.	将电感器用(260±5) °C, (20±5) s 焊在带有 0.3 mm 厚锡膏的基板上, 然后用治具垂直电极面方向加压 10 N, (10±1) s。 Inductors shall be subjected to (260±5) °C for (20±5) s Soldering in the base whit 0.3mm solder. And then aplomb electrode way plus tax 10 N for (10±1) seconds.
5	耐高温 High temperature	外观无可见机械损伤; 电感量变化率: ±10%以内。 No visible mechanical damage. Inductance change: Within ±10%	温度(+85 ± 2) °C, 时间(96±2) h; Temperature is (+85±2) °C and keep (96±2) hours.
6	耐低温 Low temperature	外观无可见机械损伤; 电感量变化率: ±10%以内。 No visible mechanical damage. Inductance change: Within ±10%	温度(-40 °C ± 2) °C, 时间(96±2) h; Temperature is (-40±2) °C and keep (96±2) hours.

序号 No.	项目 Items	要求 Requirements	试验方法及备注 Test Methods and Remarks
7	温度变化 Thermal shock	外观无可见机械损伤; 电感量变化率: $\pm 10\%$ 以内。 No visible mechanical damage. Inductance change: Within $\pm 10\%$	$(-40\pm 3)^\circ\text{C}$, 时间 (30 ± 3) min \leftrightarrow $(125^\circ\text{C}\pm 2)^\circ\text{C}/(30\pm 3)$ min, 转换时间 $(2\sim 3)$ min, 循环32次; 在室温下放置 2 小时后、48 小时内测试。 The test sample shall be placed at $(-40\pm 3)^\circ\text{C}$ and $(125\pm 2)^\circ\text{C}$ for (30 ± 3) min, different temperature conversion time is 2~3 minutes. The temperature cycle shall be repeated 32 cycles. Placed at room temperature for 2 hours, within 48 hours of testing.
8	温度特性 Temperature characteristic	电感量变化率 P_{c-b}, P_{c-d} 不超过 $\pm 20\%$ 。 Inductance change P_{c-b}, P_{c-d} : Within $\pm 20\%$	a: $+20^\circ\text{C}$ (30~45) min \rightarrow b: -40°C (30~45) min \rightarrow c: $+20^\circ\text{C}$ (30~45) min \rightarrow d: $+125^\circ\text{C}$ (30~45) min \rightarrow e: $+20^\circ\text{C}$ (30~45) min $P_{c-b} = \frac{L_b - L_c}{L_c} \times 100\%$; $P_{c-d} = \frac{L_d - L_c}{L_c} \times 100\%$
9	恒定湿热 Static Humidity	外观无可见机械损伤; 电感量变化率: $\pm 10\%$ 以内。 No visible mechanical damage. Inductance change: Within $\pm 10\%$	将电感器放置在于湿度 $(93\pm 3)\%RH$, 温度 $(40\pm 2)^\circ\text{C}$ 的环境中存放 (1000 ± 2) h, 在室温下放置2 小时后、48 小时内测试。 Inductors shall be subjected to $(93\pm 3)\%RH$. at $(60\pm 2)^\circ\text{C}$ for (96 ± 2) h . Placed at room temperature for 2 hours, within 48 hours of testing.
10	耐久性 (寿命) Life	外观无可见机械损伤; 电感量变化率: $\pm 10\%$ 以内。 No visible mechanical damage. Inductance change: Within $\pm 10\%$	温度 $(85\pm 2)^\circ\text{C}$, 时间 (1000 ± 24) h, 施加 I_{rms} , 在室温下放置2 小时后、48 小时内测试。 Inductors shall be store at $(85\pm 2)^\circ\text{C}$ for (1000 ± 24) hours with I_{rms} applied. Placed at room temperature for 2 hours, within 48 hours of testing.

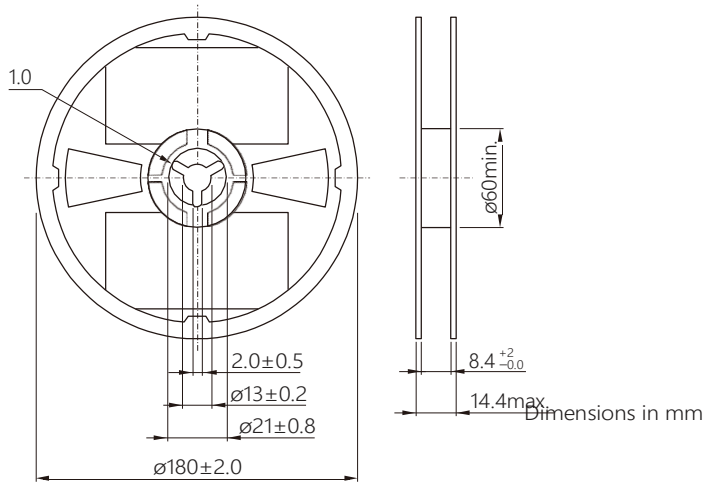
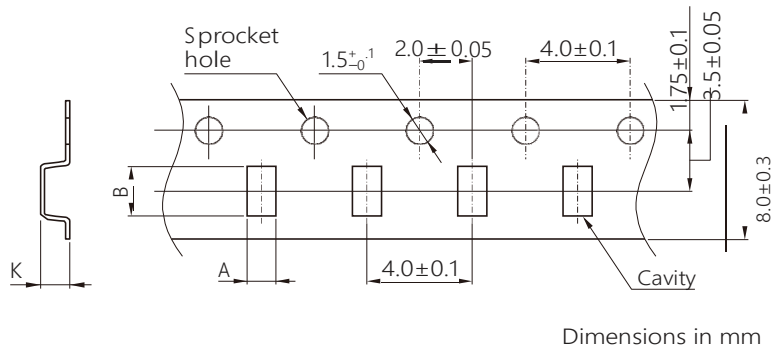
◆ Taping reel dimensions

◆ Carrier tape dimensions

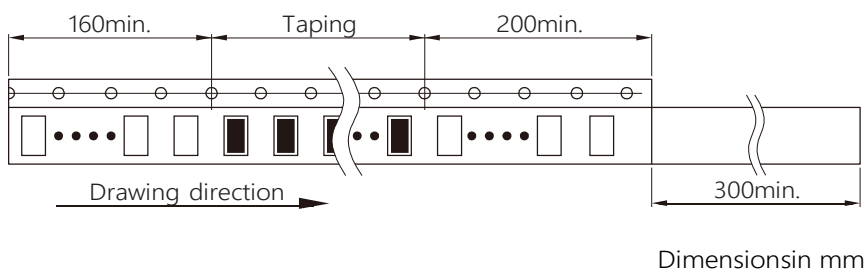
Series Type	A	B	K
CMLO252010T	2.2	2.7	1.3

◆ Package quantity

Package quantity	3000 pcs/reel
------------------	---------------