

General Description

The TPRT9078 is a low-dropout (LDO) voltage regulator with enable function that operates from a 1.2V to 5.5V supply. It provides up to 450mA of output current in miniaturized packaging.

The feature of 2 μ A low quiescent current and 0.5 μ A shutdown current are ideal for the battery application with long service life. The other features include current limit function, over temperature protection and output discharge function.

Features

- 2 μ A Ground Current at no Load
- $\pm 2\%$ Output Accuracy
- 450mA Output Current
- 10nA Disable Current (by option)
- Wide Operating Input Voltage Range: 1.2V to 5.5V
- Dropout Voltage: 0.18V at 300mA ($V_{OUT}=3.3V$)
- Support Fixed Output Voltage 1.2V, 1.5V, 1.6V, 1.8V, 2.5V, 2.8V, 3.0V, 3.3V
- Stable with Ceramic or Tantalum Capacitor
- Current Limit Protection
- Over-Temperature Protection
- SOT23-3, SOT23-5, DFN-4(1x1) and DFN-6(2x2) Packages Available

Applications

- Portable, Battery Powered Equipment
- Low Power Microcontrollers
- Laptop, Palmtops and PDAs
- Wireless Communication Equipment
- Audio/Video Equipment

Ordering Information

TPRT9078-18GJ5

GJ5: SOT23-5 Package
GQZ: DFN1X1 Package

Output voltage: 12=1.2V
15=1.5V
18=1.8V
30=3.0V
33=3.3V
XX=X.XV

Marking Information

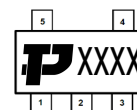

TP: Logo
XXX: Marking ID

BLOCK DIAGRAM

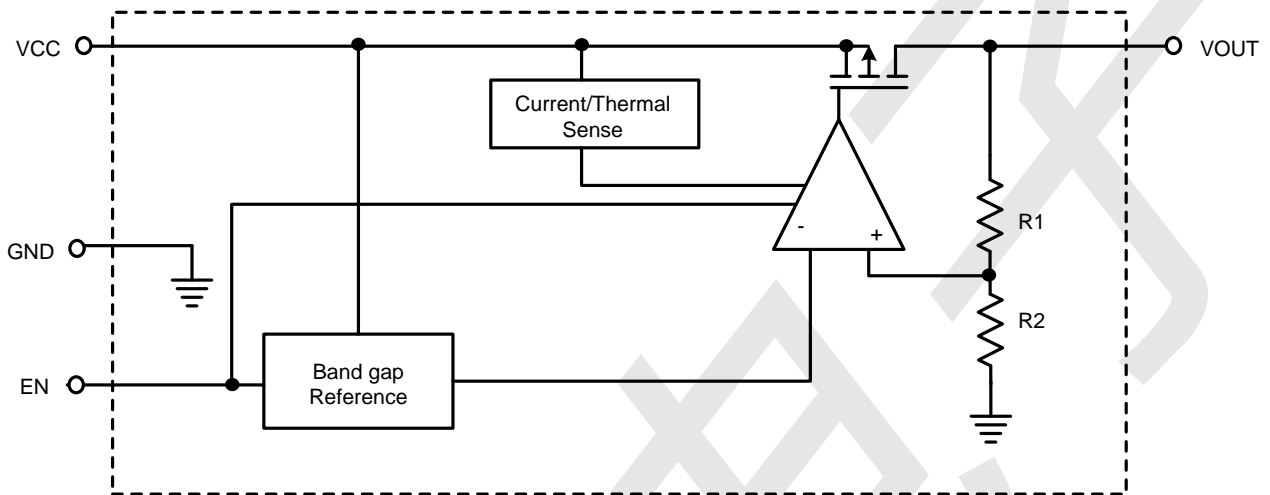

PIN CONFIGURATION

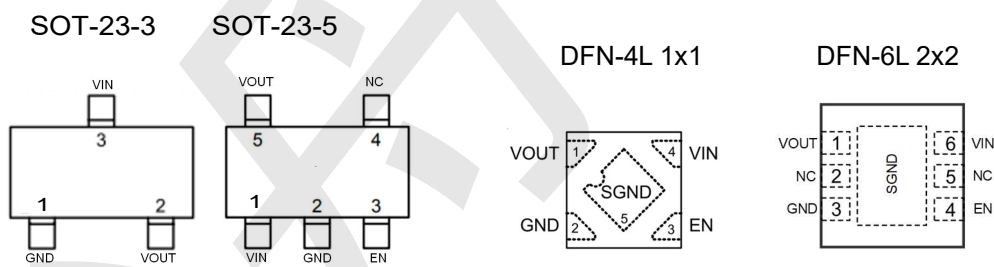

Pin No				Pin Name	Pin Function
SOT-23-3	SOT-23-5	DFN-1X1	DFN-2X2		
1	2	2	3	GND	Ground
2	5	1	1	VOUT	Output of the Regulator
3	1	4	6	VIN	Input of Supply Voltage.
	3	3	4	EN	Enable Control Input.
	4		2,5	NC	No internal connection

Absolute Maximum Rating ($T_A=25^{\circ}\text{C}$ unless otherwise noted)

VIN Pin to GND Pin Voltage	-0.3V to 6.5V
VOUT Pin and EN Pin to GND Pin Voltage	-0.3V to 6V
VOUT Pin to VIN Pin Voltage	-6V to 0.3V
Storage Temperature Range	-60°C~150°C
Lead Temperature (Soldering, 10 sec)	260°C
Junction Temperature	150°C
Operating Ambient Temperature Range T_A	-40°C~85°C
Thermal Resistance Junction to Case, $R_{\theta JC}$	
SOT23-3	115°C/W
SOT23-5	115°C/W
DFN-4(1x1)	65°C/W
DFN-6(2x2)	30°C/W
Thermal Resistance Junction to Ambient, $R_{\theta JA}$	
SOT23-3	250°C/W
SOT23-5	250°C/W
DFN-4(1x1)	195°C/W
DFN-6(2x2)	165°C/W

Electrical Characteristics (T =25°C unless otherwise noted)

(V_{IN}=5V, V_{EN}=5V, T_A=25°C, unless otherwise specified) (Note 1)

PARAMETER	TEST CONDITIONS	SYMBOL	MIN.	TYP.	MAX.	UNIT
Supply Voltage		V _{IN}	1.2		5.5	V
DC Output Voltage Accuracy	I _{LOAD} =0.1mA		-2		2	%
SNS Input Current	SNS=V _{OUT}	I _{SNS}		0.5		μA
Dropout Voltage (Note 2)	I _{LOAD} =300mA, V _{OUT} ≥3V	V _{DROP_3V}		0.18		V
	I _{LOAD} =300mA, V _{OUT} =2.8V	V _{DROP_2.8V}		0.23		
	I _{LOAD} =300mA, V _{OUT} =2.5V	V _{DROP_2.5V}		0.23		
	I _{LOAD} =300mA, V _{OUT} =1.8V	V _{DROP_1.8V}		0.28		
	I _{LOAD} =300mA, V _{OUT} =1.5V	V _{DROP_1.5V}		0.36		
	I _{LOAD} =300mA, V _{OUT} =1.2V	V _{DROP_1.2V}		0.45		
GND Current	I _{LOAD} =0mA	I _Q		2		μA
Shutdown GND Current	V _{EN} =0V, V _{OUT} =0V	I _{SD}		0.1	0.5	μA
V _{OUT} Shutdown Leakage Current	V _{EN} =0V, V _{OUT} =0V	I _{LEAK}		0.1	0.5	μA
Enable Threshold Voltage	EN Rising	V _{IH}	1.0			V
	EN Falling	V _{IL}			0.4	
EN Input Current	V _{EN} =5V	I _{EN}		10	100	nA
Line Regulation	I _{LOAD} =30mA, 1.5V≤V _{IN} ≤5.5V or (V _{OUT} +0.2V)≤V _{IN} ≤5.5V	ΔLINE		0.2		%
Load Regulation	10mA≤I _{LOAD} ≤300mA	ΔLOAD		0.2		%
Output Current Limit	V _{OUT} =0V	I _{LIM}	450	500		mA
Power Supply Rejection Ratio	V _{OUT} =1.2V, I _{LOAD} =5mA, V _{IN} =2V, f=100Hz	PSRR		80		dB
	V _{OUT} =1.2V, I _{LOAD} =5mA, V _{IN} =2V, f=1kHz			75		
Output Voltage Noise	V _{IN} =3.5V, I _{LOAD} =0.1A, BW=10Hz to 100kHz, C _{OUT} =1μF, V _{OUT} =1.2V			80		μV _{RMS}
	V _{IN} =3.5V, I _{LOAD} =0.1A, BW=10Hz to 100kHz, C _{OUT} =1μF, V _{OUT} =2.8V			120		
Thermal Shutdown Temperature	I _{LOAD} =10mA	T _{SD}		155		°C
Thermal Shutdown Hysteresis	I _{LOAD} =10mA	ΔT _{SD}		15		°C
Discharge Resistance	V _{EN} =0V, V _{OUT} =0.1V			100		Ω

TYPICAL APPLICATION

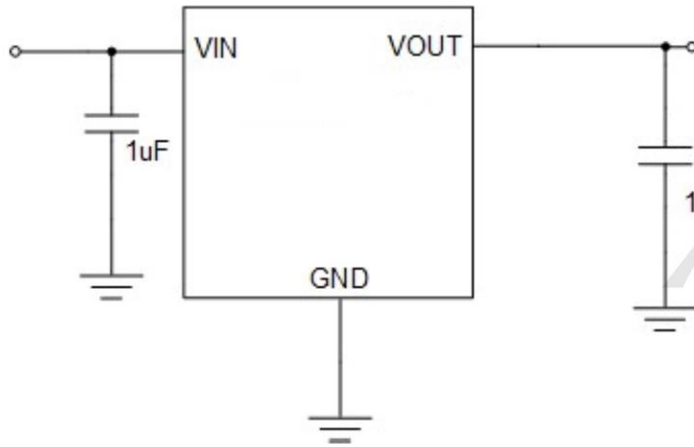

Figure 1: Application circuit of Fixed V_{OUT} LDO

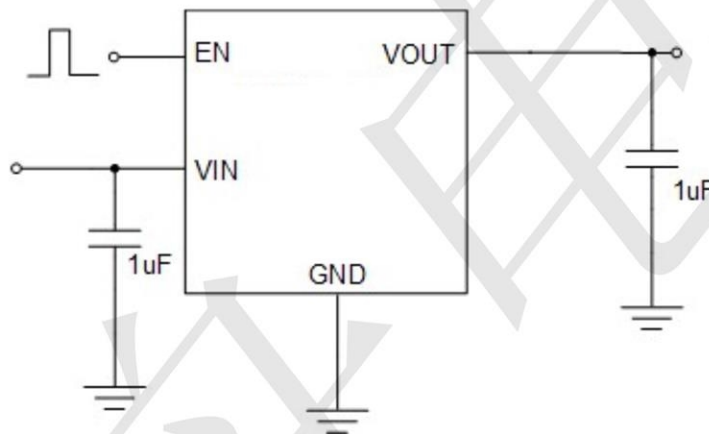

Figure 2: Application circuit of Fixed V_{OUT} LDO with enable function

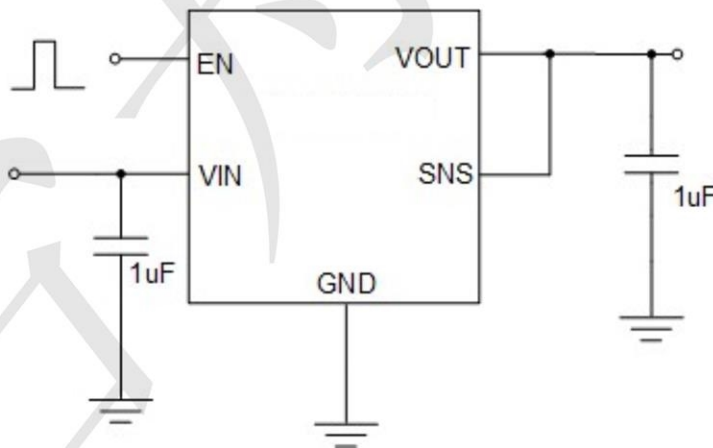
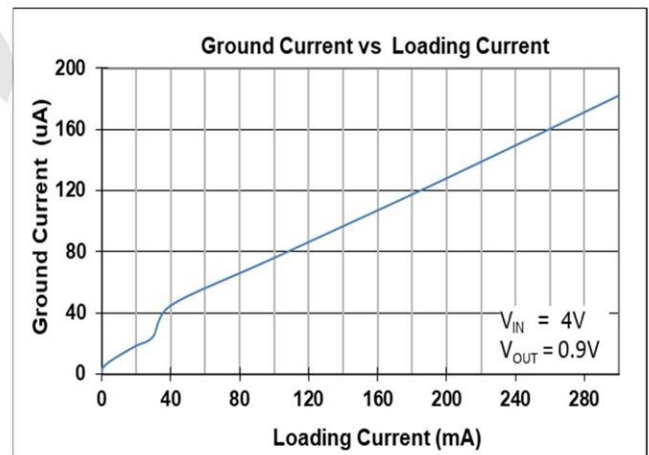
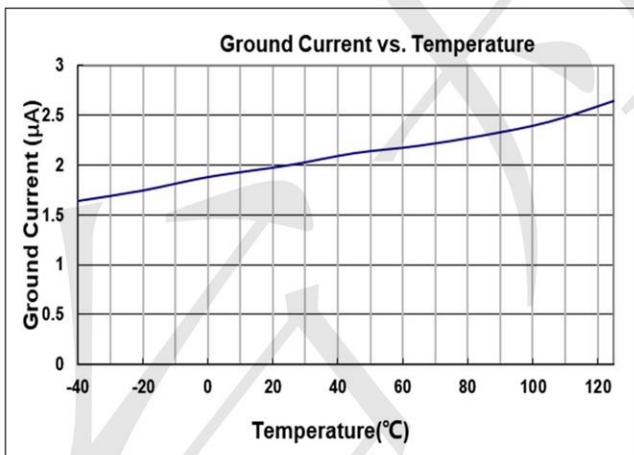
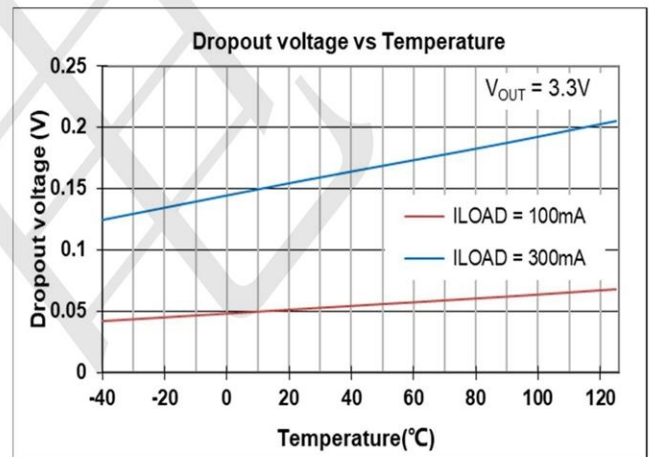
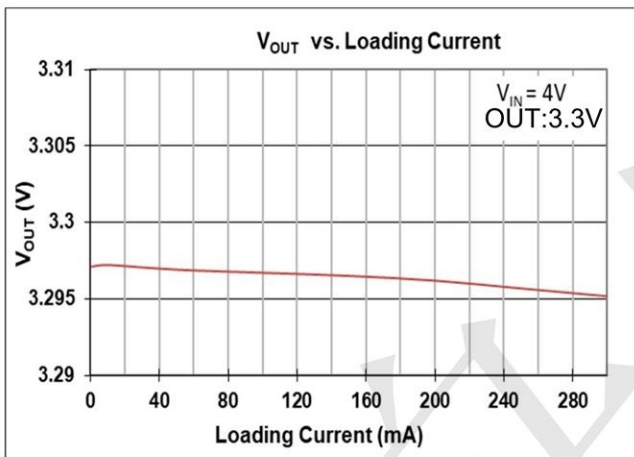
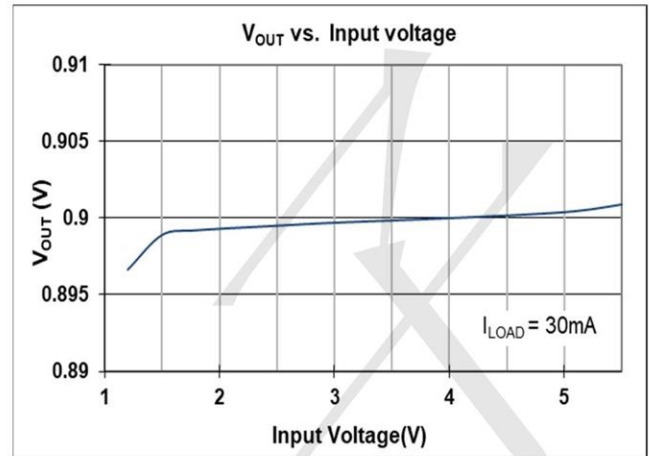
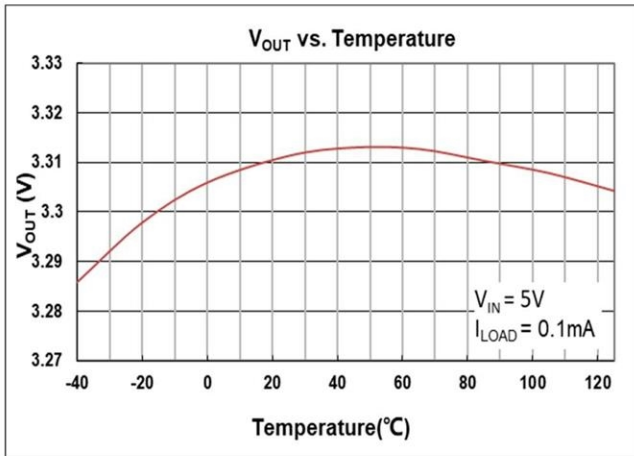
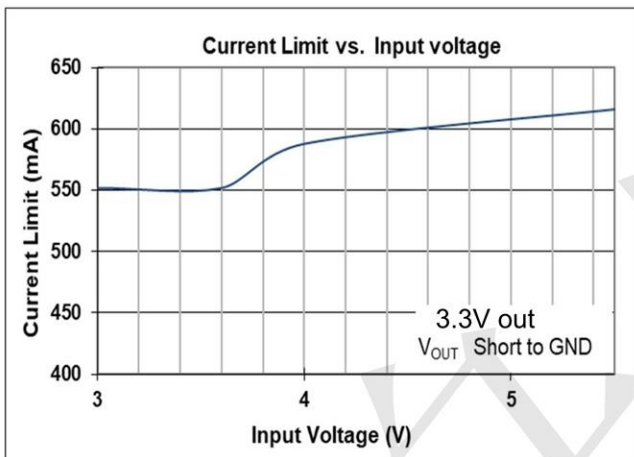
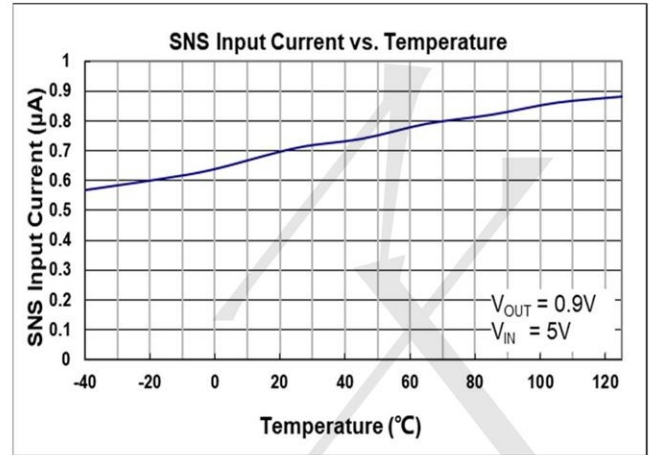
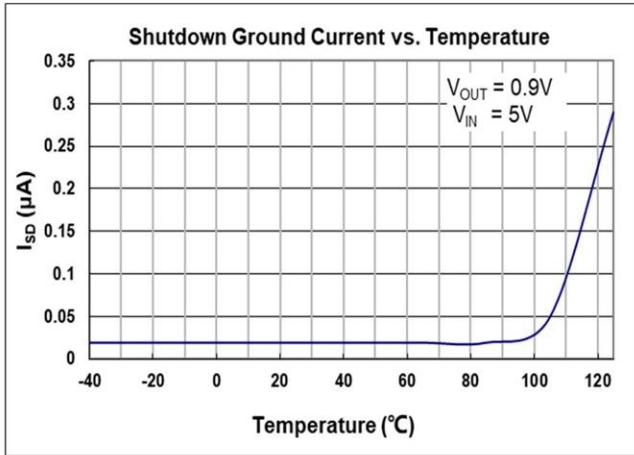
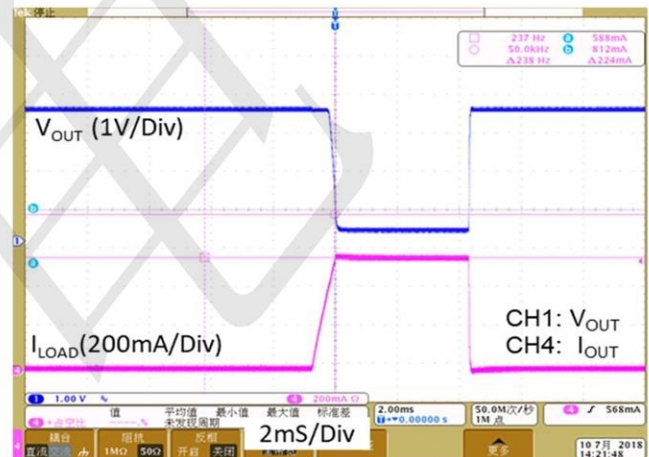

Figure 3: Application circuit of Fixed V_{OUT} LDO with enable and sense functions





Current Limit Response



Load Transient Response I

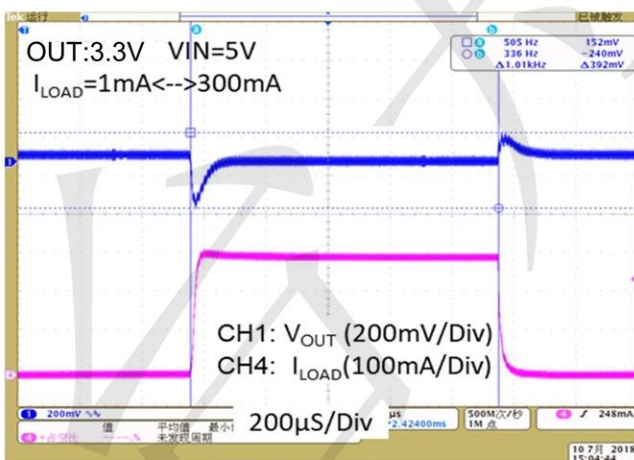

Load Transient Response II

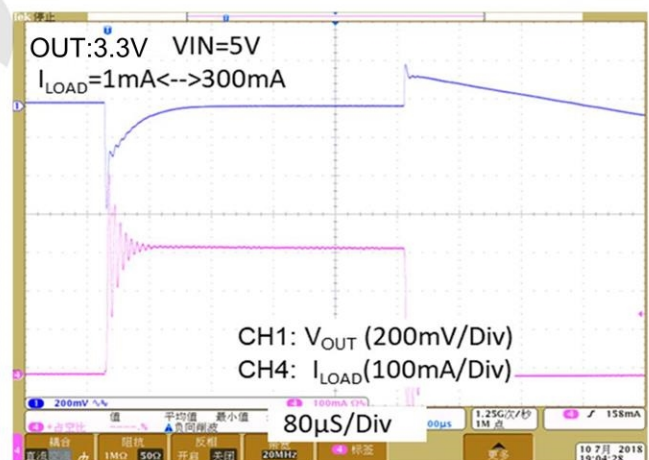

Line Transient Response

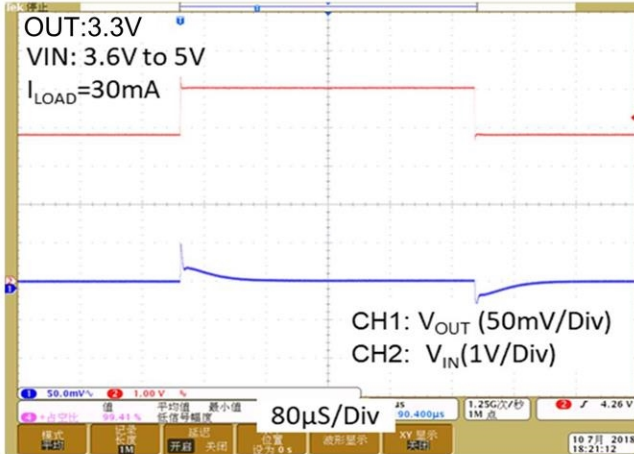

V_{OUT} Turn On/Off by EN

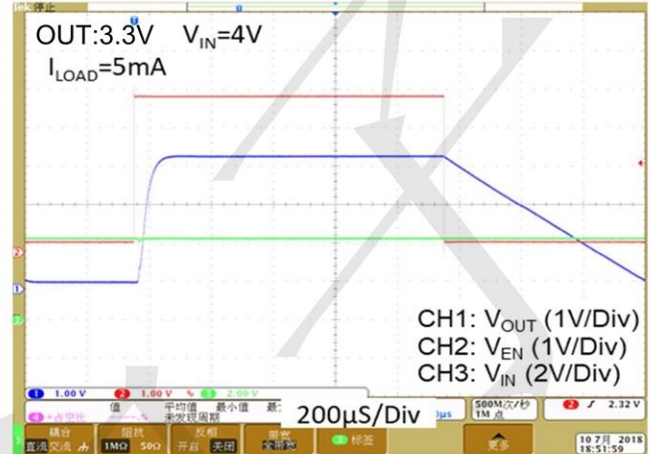



Package informantion

DFN2X2-6L Outline Dimensions

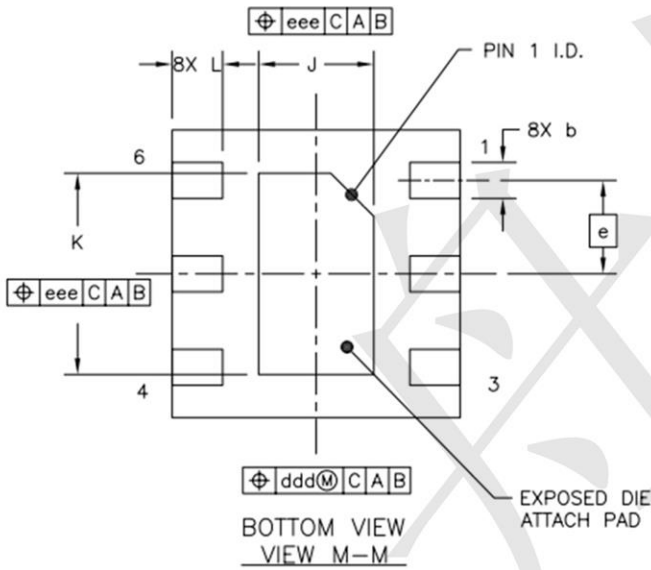
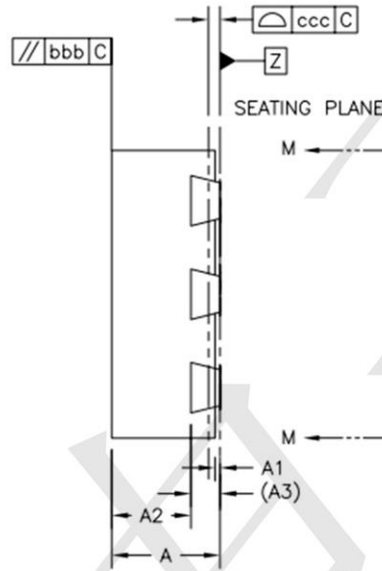
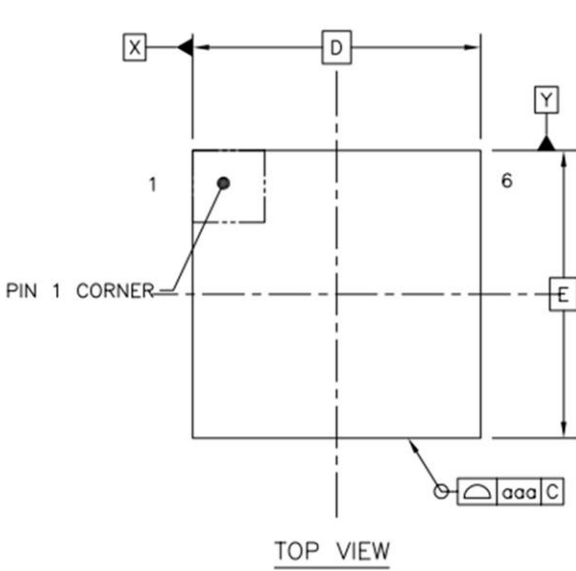

DESCRIPTION	SYMBOL	MILLIMETER			
		MIN	NOM	MAX	
TOTAL THICKNESS	A	0.7	0.75	0.8	
STAND OFF	A1	0	0.035	0.05	
MOLD THICKNESS	A2	---	0.55	0.575	
L/F THICKNESS	A3	0.203 REF			
LEAD WIDTH	b	0.20	0.25	0.30	
BODY SIZE	X	D 2 BSC			
	Y	E 2 BSC			
LEAD PITCH	e	0.65 BSC			
EP SIZE	X	J	0.75	0.8	0.85
	Y	K	1.35	1.4	1.45
LEAD LENGTH	L	0.30	0.35	0.40	
PACKAGE EDGE TOLERANCE	aaa	0.05			
MOLD FLATNESS	bbb	0.1			
COPLANARITY	ccc	0.08			
LEAD OFFSET	ddd	0.1			
EXPOSED PAD OFFSET	eee	0.1			

NOTES

1.0 COPLANARITY APPLIES TO LEADS, CORNER LEADS AND DIE ATTACH PAD.



Package informantion

4-pin DFN-4L Outline Dimensions

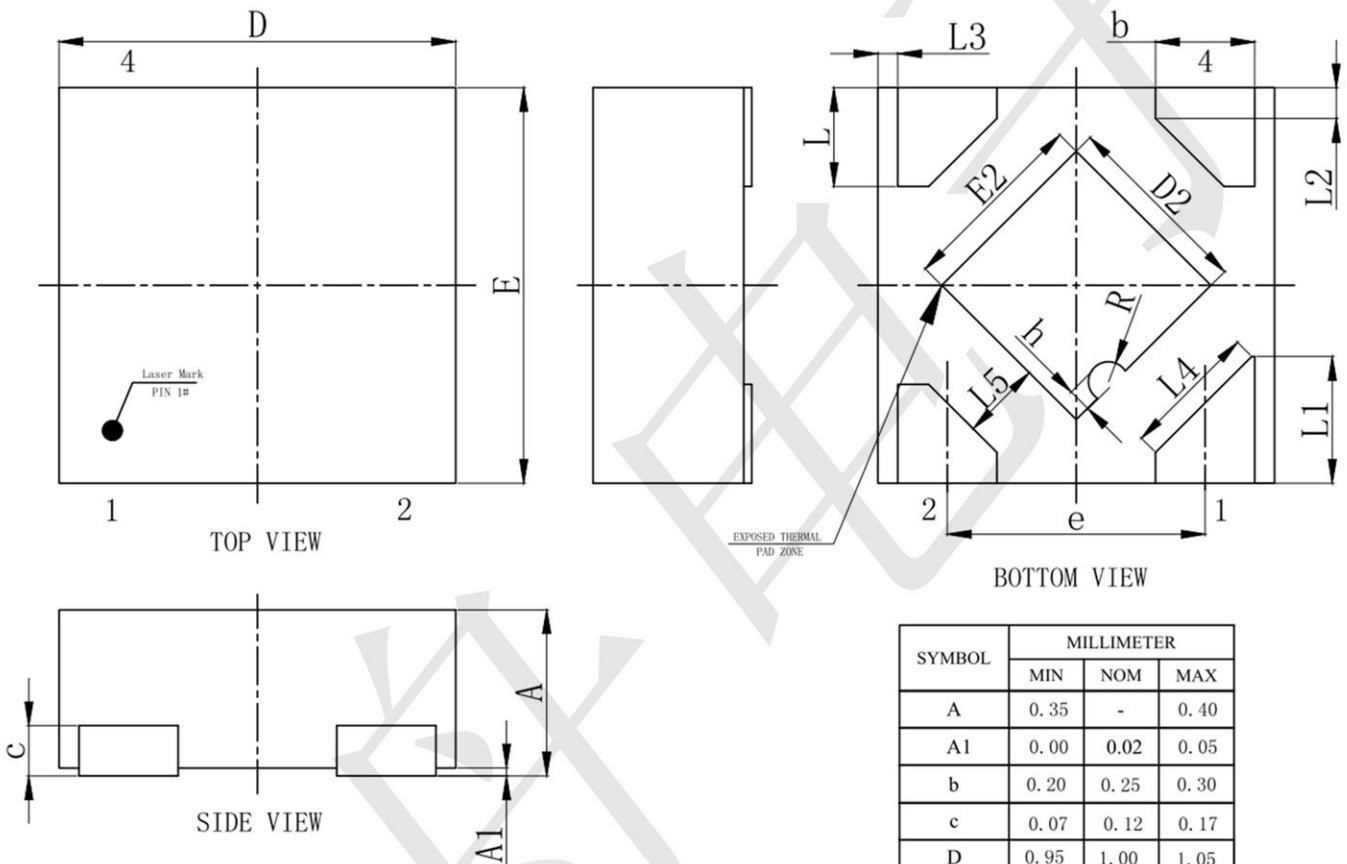

SYMBOL	MILLIMETER		
	MIN	NOM	MAX
A	0.35	-	0.40
A1	0.00	0.02	0.05
b	0.20	0.25	0.30
c	0.07	0.12	0.17
D	0.95	1.00	1.05
D2	0.38	0.48	0.58
e	0.65BSC		
E	0.95	1.00	1.05
E2	0.38	0.48	0.58
L	0.20	0.25	0.30
L1	0.27	0.32	0.37
L2	0.077REF		
L3	0.05REF		
L4	0.34REF		
L5	0.20REF		
R	0.05REF		
h	0.06REF		



Package informantion

3-pin SOT23-3 Outline Dimensions

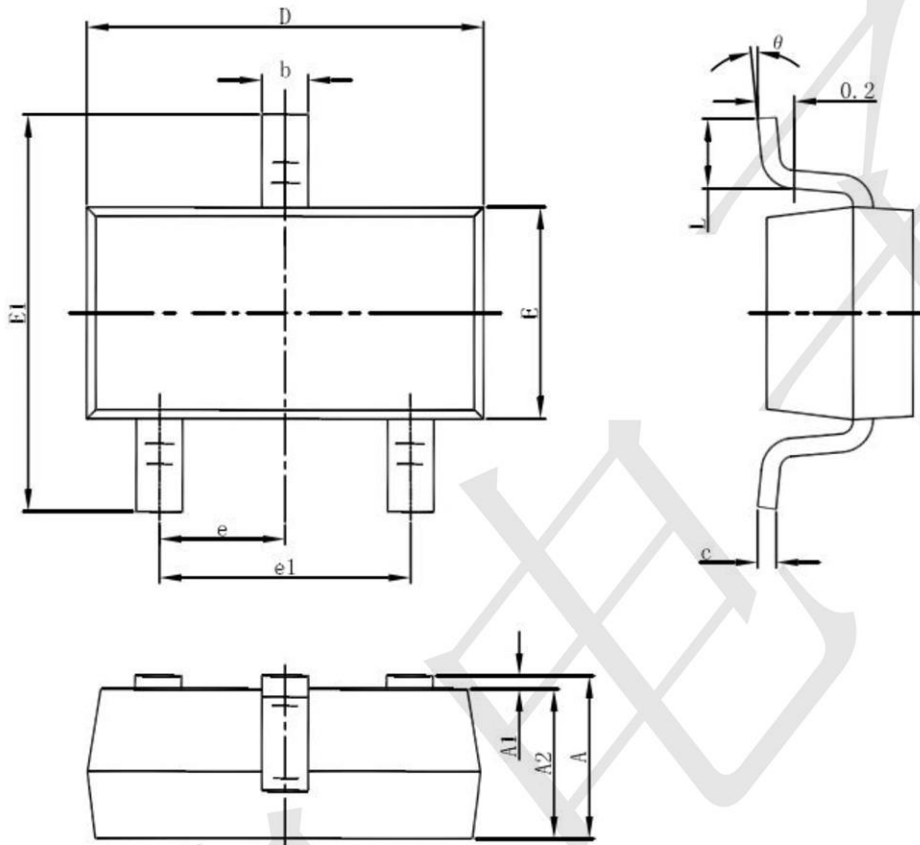

Symbol	Dimensions In Millimeters		Dimensions In Inches	
	Min	Max	Min	Max
A	1.050	1.250	0.041	0.049
A1	0.000	0.100	0.000	0.004
A2	1.050	1.150	0.041	0.045
b	0.300	0.500	0.012	0.020
c	0.100	0.200	0.004	0.008
D	2.820	3.020	0.111	0.119
E	1.500	1.700	0.059	0.067
E1	2.650	2.950	0.104	0.116
e	0.950(BSC)		0.037(BSC)	
e1	1.800	2.000	0.071	0.079
L	0.300	0.600	0.012	0.024
θ	0°	8°	0°	8°



Package informantion

3-pin SOT23-5 Outline Dimensions

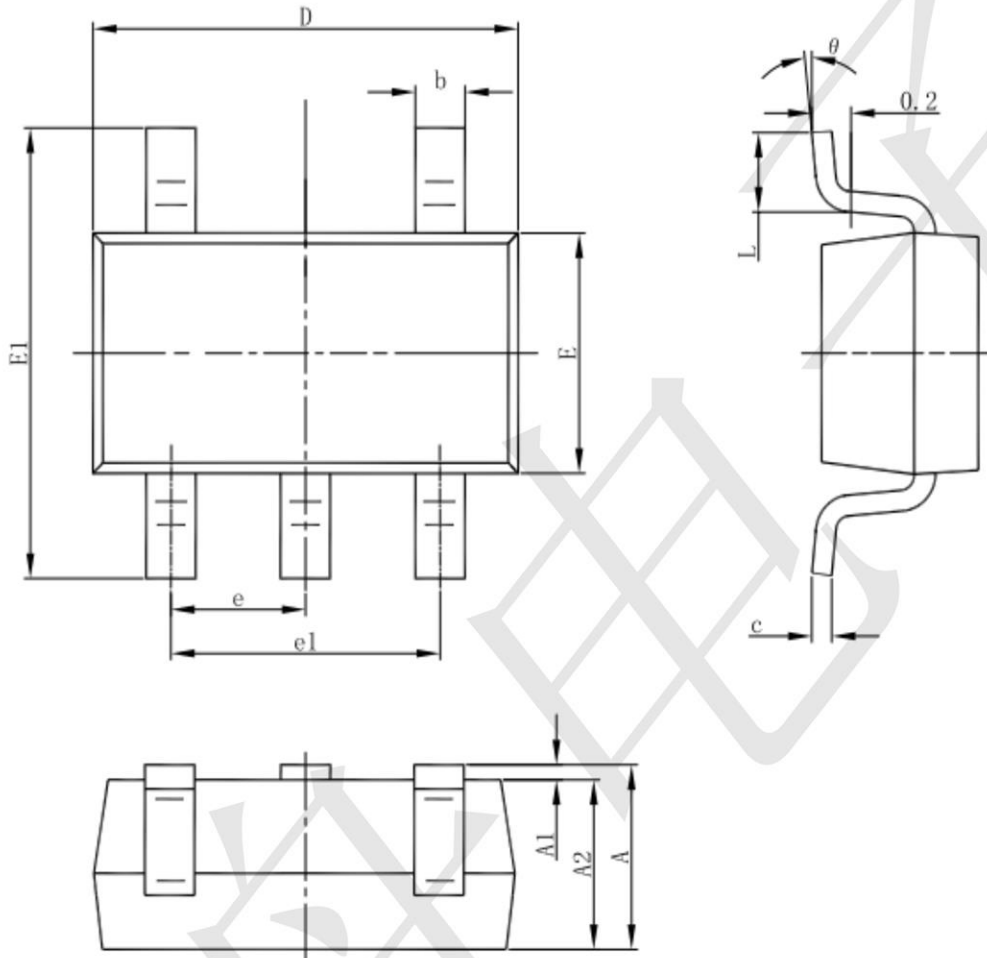

Symbol	Dimensions In Millimeters		Dimensions In Inches	
	Min	Max	Min	Max
A	1.050	1.250	0.041	0.049
A1	0.000	0.100	0.000	0.004
A2	1.050	1.150	0.041	0.045
b	0.300	0.500	0.012	0.020
c	0.100	0.200	0.004	0.008
D	2.820	3.020	0.111	0.119
E	1.500	1.700	0.059	0.067
E1	2.650	2.950	0.104	0.116
e	0.950(BSC)		0.037(BSC)	
e1	1.800	2.000	0.071	0.079
L	0.300	0.600	0.012	0.024
theta	0°	8°	0°	8°