

GENERAL FEATURES

- $V_{DS} = -30V$ $I_D = -60A$
- $R_{DS(ON)} < 11\text{ m}\Omega$ @ $V_{GS}=10V$

Application

- Load/Power Switching
- Interfacing Switching
- Logic Level Shift

Package and Pin Configuration



SOP-8 top view

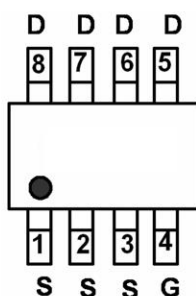

Circuit diagram

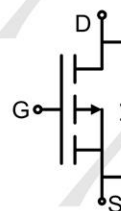

Marking:



Absolute Maximum Ratings ($T_A=25^\circ\text{C}$ unless otherwise noted)

Symbol	Parameter	Rating		Units
		10s	Steady State	
V_{DS}	Drain-Source Voltage	-30		V
V_{GS}	Gate-Source Voltage	± 20		V
$I_D@T_C=25^\circ\text{C}$	Continuous Drain Current, $V_{GS} @ -10V^1$	-15		A
$I_D@T_C=100^\circ\text{C}$	Continuous Drain Current, $V_{GS} @ -10V^1$	-12		A
$I_D@T_A=25^\circ\text{C}$	Continuous Drain Current, $V_{GS} @ -10V^1$	-14.3	-9	A
$I_D@T_A=70^\circ\text{C}$	Continuous Drain Current, $V_{GS} @ -10V^1$	-11.4	-7.2	A
IDM	Pulsed Drain Current ²	-130		A
EAS	Single Pulse Avalanche Energy ³	125		mJ
IAS	Avalanche Current	-50		A
$P_D@T_C=25^\circ\text{C}$	Total Power Dissipation ⁴	37		W
$P_D@T_A=25^\circ\text{C}$	Total Power Dissipation ⁴	4.2	1.67	W
TSTG	Storage Temperature Range	-55 to 150		$^\circ\text{C}$
T_J	Operating Junction Temperature Range	-55 to 150		$^\circ\text{C}$

Electrical Characteristics (T_A=25°C unless otherwise noted)

Symbol	Parameter	Conditions	Min.	Typ.	Max.	Unit
BV _{DSS}	Drain-Source Breakdown Voltage	V _{GS} =0V, I _D =-250μA	-30	---	---	V
ΔBV _{DSS} /ΔT _J	BVDSS Temperature Coefficient	Reference to 25°C, I _D =-1mA	---	-0.0232	---	V/°C
R _{DS(ON)}	Static Drain-Source On-Resistance ²	V _{GS} =-10V, I _D =-10A	---	---	11	mΩ
		V _{GS} =-4.5V, I _D =-8A	---	---	20	
V _{GS(th)}	Gate Threshold Voltage		-1.2	---	-2.5	V
ΔV _{GS(th)}	V _{GS(th)} Temperature Coefficient	V _{GS} =V _{DS} , I _D =-250μA	---	4.6	---	mV/°C
I _{DSS}	Drain-Source Leakage Current	V _{DS} =-24V, V _{GS} =0V, T _J =25°C	---	---	-1	μA
		V _{DS} =-24V, V _{GS} =0V, T _J =55°C	---	---	-5	
I _{GSS}	Gate-Source Leakage Current	V _{GS} =±20V, V _{DS} =0V	---	---	±100	nA
g _{fs}	Forward Transconductance	V _{DS} =-5V, I _D =-30A	---	30	---	S
R _g	Gate Resistance	V _{DS} =0V, V _{GS} =0V, f=1MHz	---	9	---	Ω
Q _g	Total Gate Charge (-4.5V)		---	22	---	nC
Q _{gs}	Gate-Source Charge	V _{DS} =-15V, V _{GS} =-4.5V, I _D =-15A	---	8.7	---	
Q _{gd}	Gate-Drain Charge		---	7.2	---	
T _{d(on)}	Turn-On Delay Time		---	8	---	ns
T _r	Rise Time	V _{DD} =-15V, V _{GS} =-10V, R _G =3.3	---	73.7	---	
T _{d(off)}	Turn-Off Delay Time	I _D =-15A	---	61.8	---	
T _f	Fall Time		---	24.4	---	
C _{iss}	Input Capacitance		---	2215	---	pF
C _{oss}	Output Capacitance	V _{DS} =-15V, V _{GS} =0V, f=1MHz	---	310	---	
C _{rss}	Reverse Transfer Capacitance		---	237	---	
I _S	Continuous Source Current ^{1,5}	V _G =V _D =0V, Force Current	---	---	-42	A
I _{SM}	Pulsed Source Current ^{2,5}		---	---	-130	A
V _{SD}	Diode Forward Voltage ²	V _{GS} =0V, I _S =-1A, T _J =25°C	---	---	-1	V
t _{rr}	Reverse Recovery Time	I _F =-15A, dI/dt=100A/μs, T _J =25°C	---	19	---	nS
Q _{rr}	Reverse Recovery Charge		---	9	---	nC

Typical Electrical and Thermal Characteristics

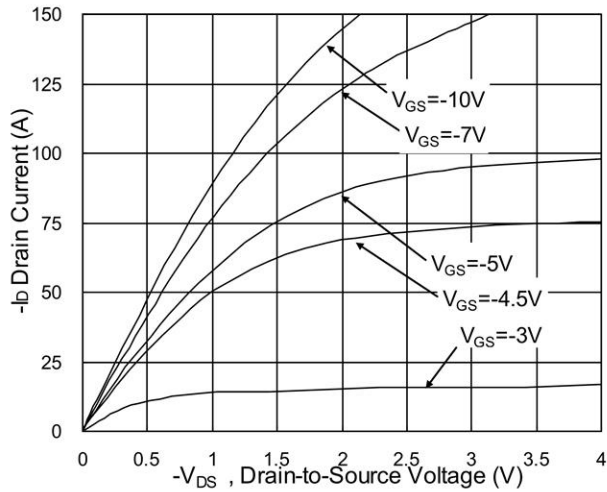

Fig.1 Typical Output Characteristics

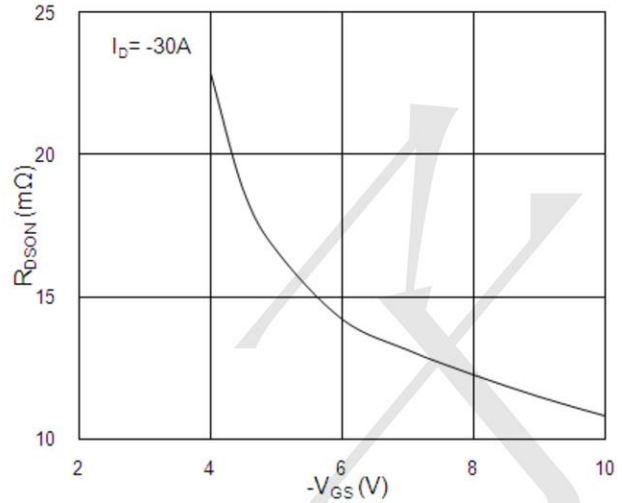

Fig.2 On-Resistance vs. G-S Voltage

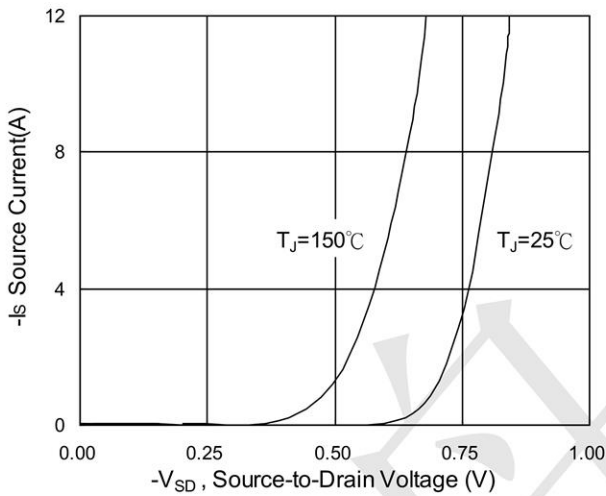

Fig.3 Forward Characteristics of Reverse

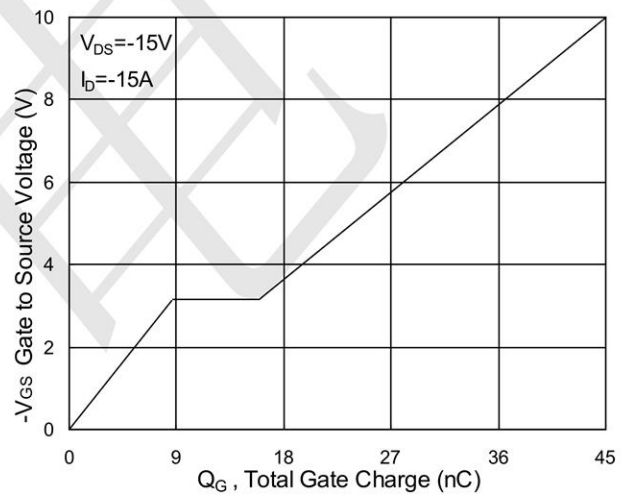

Fig.4 Gate-Charge Characteristics

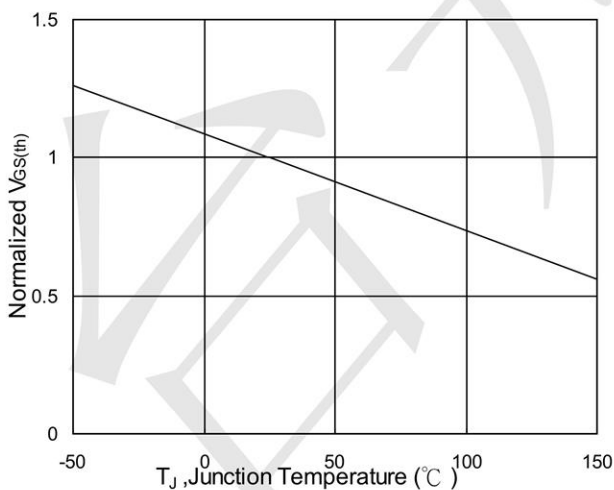

Fig.5 Normalized $V_{GS(th)}$ vs. T_J

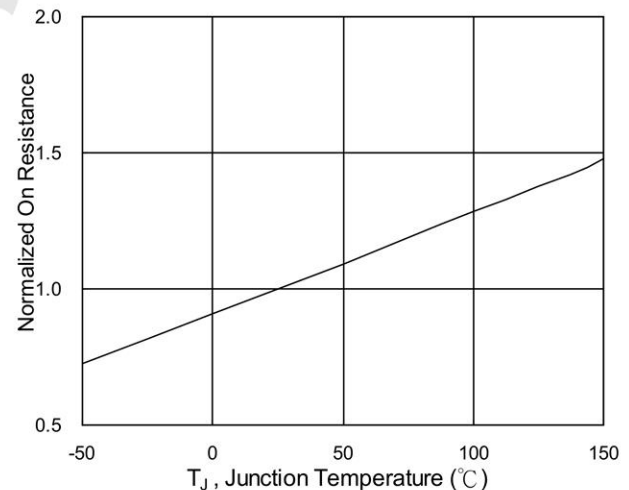

Fig.6 Normalized $R_{DS(on)}$ vs. T_J

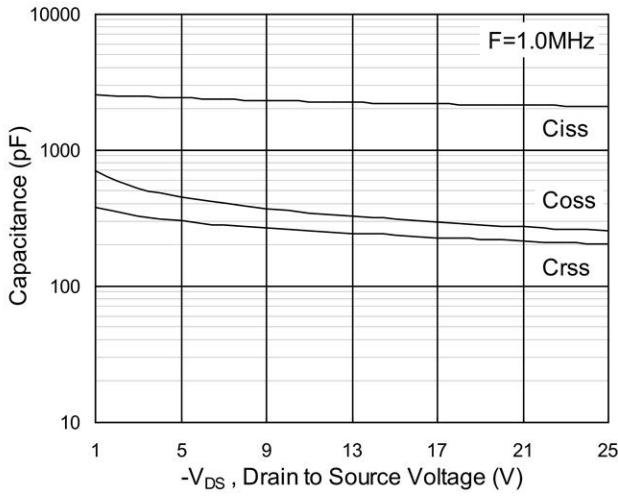

Fig.7 Capacitance

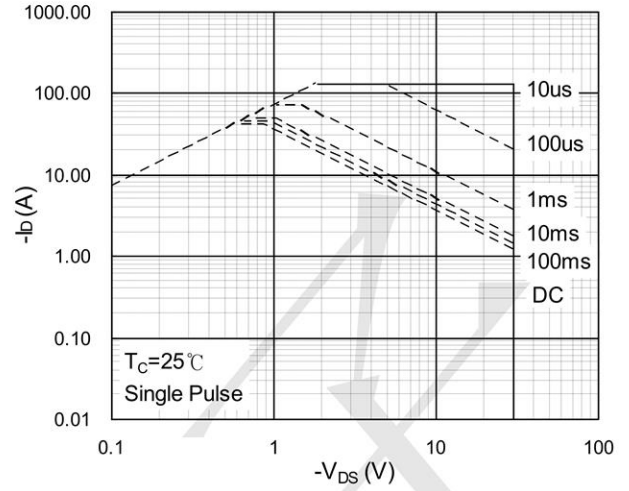

Fig.8 Safe Operating Area

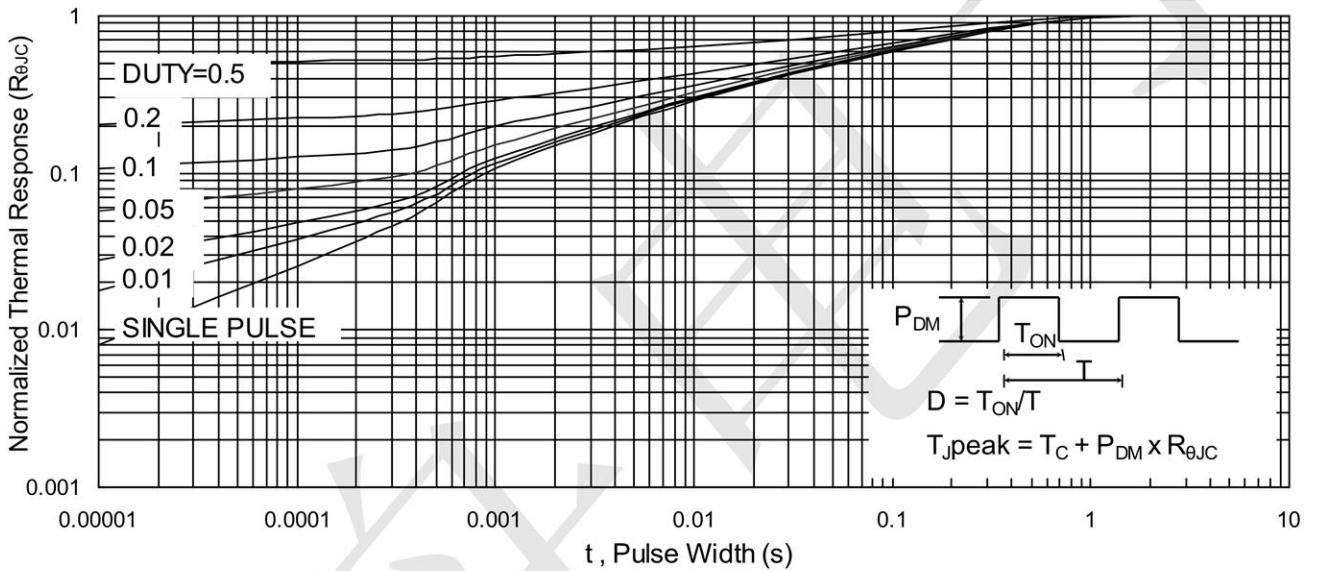

Fig.9 Normalized Maximum Transient Thermal Impedance

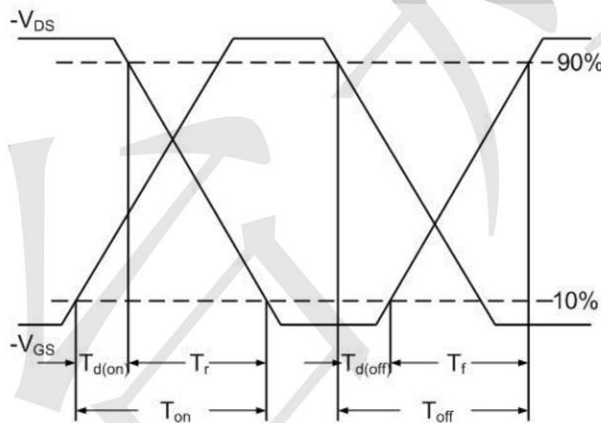

Fig.10 Switching Time Waveform

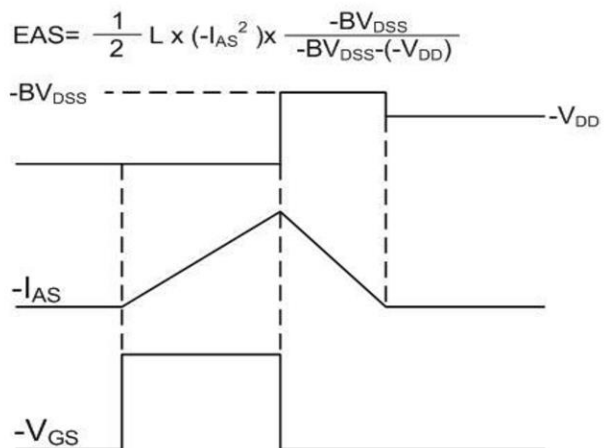
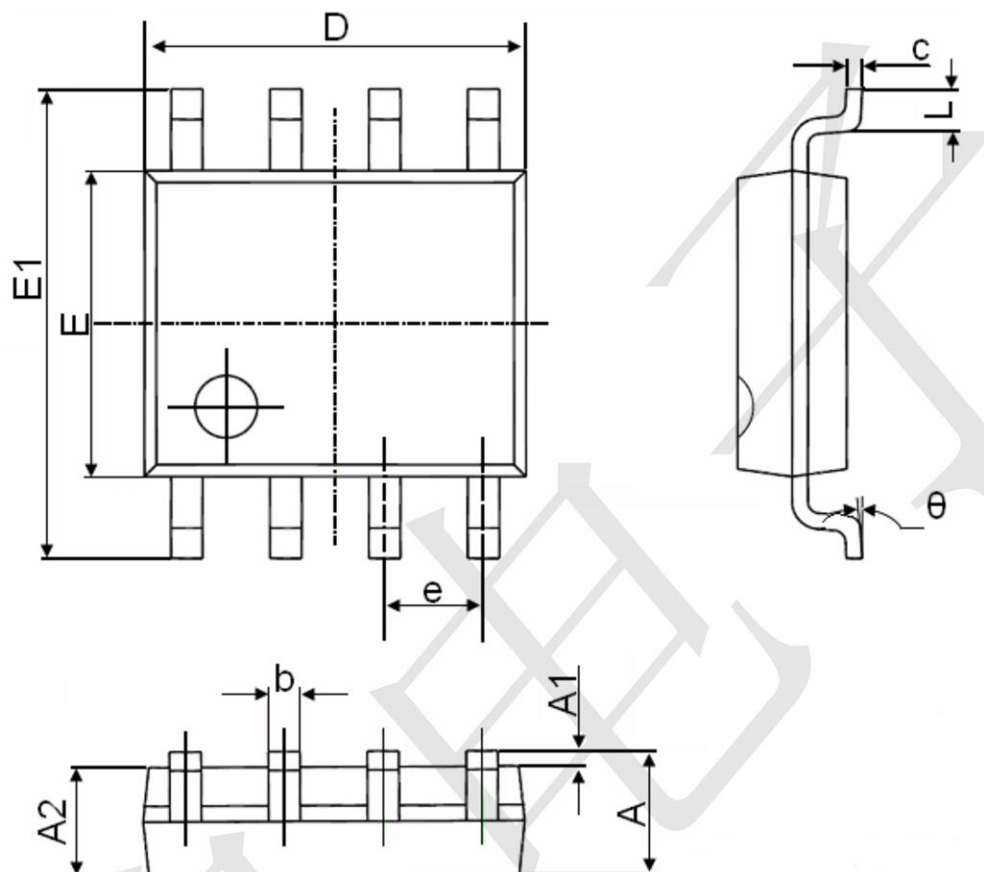

Fig.11 Unclamped Inductive Switching Waveform

SOP-8 Package Information



Symbol	Dimensions In Millimeters		Dimensions In Inches	
	Min.	Max.	Min.	Max.
A	1.350	1.750	0.053	0.069
A1	0.100	0.250	0.004	0.010
A2	1.350	1.550	0.053	0.061
b	0.330	0.510	0.013	0.020
c	0.170	0.250	0.006	0.010
D	4.700	5.100	0.185	0.200
E	3.800	4.000	0.150	0.157
E1	5.800	6.200	0.228	0.244
e	1.270(BSC)		0.050(BSC)	
L	0.400	1.270	0.016	0.050
θ	0°	8°	0°	8°