

07D Series Data Sheet

Features

- Wide operating voltage (V_{1mA}) range from 18V to 820V
- Fast responding to transient over-voltage
- Large absorbing transient energy capability
- Low clamping ratio and no follow-on current
- Meets MSL level1, per J-STD-020
- Operating temperature: $-40^{\circ}\text{C} \sim +85^{\circ}\text{C}$
- Storage Temperature: $-40^{\circ}\text{C} \sim +125^{\circ}\text{C}$

Applications

- Transistor, diode, IC, SCR or SCR semiconductor protection
- Surge protection in consumer electronics
- Surge protection in industrial electronics
- Surge protection in electronic home appliances, gas and petroleum appliances
- Relay and electromagnetic valve surge absorption

Part Number Code and Marking Code

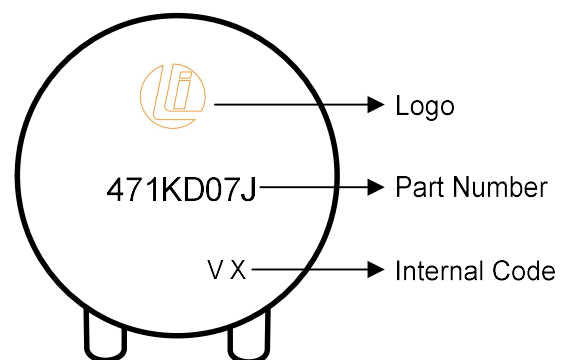
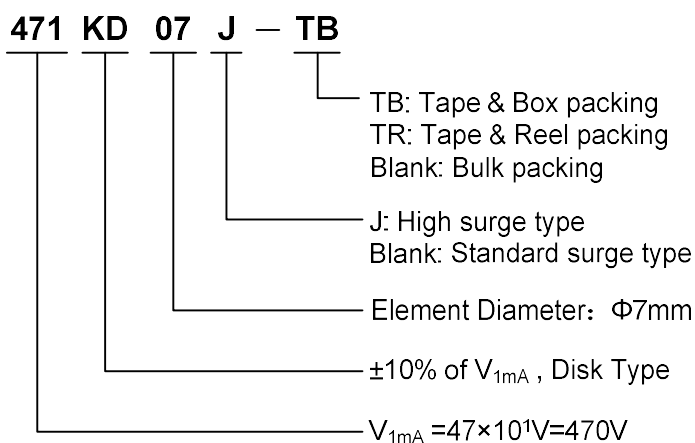

Dimensions

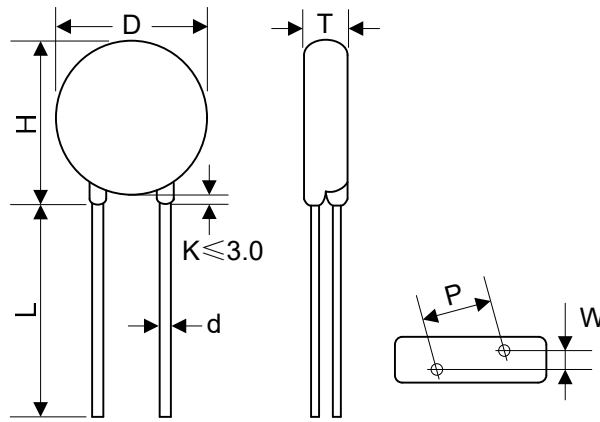

Straight leads

| Item | D | H | L | d | P | T | W |
|----------------|---------|----------|-------|----------|---------|------------------------------|---|
| Dimension (mm) | 7.0~9.0 | 7.5~12.0 | ≥20.0 | 0.6±0.05 | 5.0±0.8 | Refer to the following table | |

| Model | T | W | Model | T | W | Model | T | W |
|-------|---------|---------|-------|---------|---------|-------|---------|---------|
| 180K | 1.5~4.5 | 1.3±0.8 | 121K | 1.9~4.5 | 2.0±0.8 | 391K | 2.5~5.4 | 2.6±0.8 |
| 220K | 1.6~4.6 | 1.4±0.8 | 151K | 1.7~4.8 | 1.6±0.8 | 431K | 2.7~5.7 | 2.8±0.8 |
| 270K | 1.6~4.7 | 1.6±0.8 | 181K | 1.8~4.3 | 1.7±0.8 | 471K | 2.8~6.0 | 3.0±0.8 |
| 330K | 1.7~4.9 | 1.5±0.8 | 201K | 1.9~4.4 | 1.8±0.8 | 511K | 2.9~6.2 | 3.2±0.8 |
| 390K | 1.6~4.8 | 1.6±0.8 | 221K | 2.0~4.5 | 1.9±0.8 | 561K | 3.1~6.5 | 3.4±0.8 |
| 470K | 1.7~4.9 | 1.7±0.8 | 241K | 2.1~4.6 | 2.0±0.8 | 621K | 3.3~7.1 | 3.7±0.8 |
| 560K | 1.8~5.0 | 1.9±0.8 | 271K | 2.1~4.9 | 2.2±0.8 | 681K | 3.5~7.3 | 4.0±0.8 |
| 680K | 1.9~5.2 | 2.2±0.8 | 301K | 2.2~5.0 | 2.3±0.8 | 751K | 3.8~7.0 | 4.1±0.8 |
| 820K | 1.6~4.1 | 1.6±0.8 | 331K | 2.2~5.1 | 2.3±0.8 | 781K | 3.9~7.2 | 4.2±0.8 |
| 101K | 1.9~4.3 | 1.8±0.8 | 361K | 2.4~5.2 | 2.5±0.8 | 821K | 4.1~7.5 | 4.4±0.8 |

Electrical Characteristics

| Model | Varistor Voltage | Maximum Allowable Voltage | | Maximum Clamping Voltage | | Surge Current | Maximum Energy (10/1000 μ s) | Maximum Leakage Current @83% of V_{1mA} | Rated Power | Typical Capacitance (Reference) |
|----------|------------------|---------------------------|--------------|--------------------------|-----------|---------------|----------------------------------|---|-------------|---------------------------------|
| | V_{1mA} (V) | V_{AC} (V) | V_{DC} (V) | I_P (A) | V_C (V) | I (A) | E (J) | I_R (μ A) | P (W) | @1KHz (pF) |
| 180KD07 | 18(15~21.6) | 11 | 14 | 2.5 | 36 | 250 | 0.9 | 50 | 0.02 | 2800 |
| 180KD07J | 18(15~21.6) | 11 | 14 | 2.5 | 36 | 500 | 2 | 50 | 0.02 | 2800 |
| 220KD07 | 22(19.5~26) | 14 | 18 | 2.5 | 43 | 250 | 1.1 | 50 | 0.02 | 2300 |
| 220KD07J | 22(19.5~26) | 14 | 18 | 2.5 | 43 | 500 | 2.4 | 50 | 0.02 | 2300 |
| 270KD07 | 27(24~31) | 17 | 22 | 2.5 | 53 | 250 | 1.4 | 50 | 0.02 | 1800 |
| 270KD07J | 27(24~31) | 17 | 22 | 2.5 | 53 | 500 | 3 | 50 | 0.02 | 1800 |
| 330KD07 | 33(29.5~36.5) | 20 | 26 | 2.5 | 65 | 250 | 1.7 | 50 | 0.02 | 1500 |
| 330KD07J | 33(29.5~36.5) | 20 | 26 | 2.5 | 65 | 500 | 3.5 | 50 | 0.02 | 1500 |
| 390KD07 | 39(35~43) | 25 | 31 | 2.5 | 77 | 250 | 2.1 | 50 | 0.02 | 1300 |
| 390KD07J | 39(35~43) | 25 | 31 | 2.5 | 77 | 500 | 4 | 50 | 0.02 | 1300 |
| 470KD07 | 47(42~52) | 30 | 38 | 2.5 | 93 | 250 | 2.5 | 50 | 0.02 | 1100 |
| 470KD07J | 47(42~52) | 30 | 38 | 2.5 | 93 | 500 | 5.0 | 50 | 0.02 | 1100 |
| 560KD07 | 56(50~62) | 35 | 45 | 2.5 | 110 | 250 | 3.1 | 50 | 0.02 | 890 |
| 560KD07J | 56(50~62) | 35 | 45 | 2.5 | 110 | 500 | 6 | 50 | 0.02 | 890 |
| 680KD07 | 68(61~75) | 40 | 56 | 2.5 | 135 | 250 | 3.6 | 50 | 0.02 | 740 |
| 680KD07J | 68(61~75) | 40 | 56 | 2.5 | 135 | 500 | 7 | 50 | 0.02 | 740 |
| 820KD07 | 82(74~90) | 50 | 65 | 10 | 135 | 1200 | 5 | 25 | 0.25 | 600 |
| 820KD07J | 82(74~90) | 50 | 65 | 10 | 135 | 1750 | 10 | 25 | 0.25 | 600 |
| 101KD07 | 100(90~110) | 60 | 85 | 10 | 165 | 1200 | 6.5 | 25 | 0.25 | 500 |
| 101KD07J | 100(90~110) | 60 | 85 | 10 | 165 | 1750 | 12 | 25 | 0.25 | 500 |
| 121KD07 | 120(108~132) | 75 | 100 | 10 | 200 | 1200 | 7.8 | 25 | 0.25 | 420 |
| 121KD07J | 120(108~132) | 75 | 100 | 10 | 200 | 1750 | 13 | 25 | 0.25 | 420 |
| 151KD07 | 150(135~165) | 95 | 125 | 10 | 250 | 1200 | 9.7 | 25 | 0.25 | 330 |
| 151KD07J | 150(135~165) | 95 | 125 | 10 | 250 | 1750 | 15 | 25 | 0.25 | 330 |
| 181KD07 | 180(162~198) | 115 | 150 | 10 | 300 | 1200 | 11.7 | 25 | 0.25 | 280 |
| 181KD07J | 180(162~198) | 115 | 150 | 10 | 300 | 1750 | 16 | 25 | 0.25 | 280 |
| 201KD07 | 200(180~220) | 130 | 170 | 10 | 340 | 1200 | 13 | 25 | 0.25 | 250 |
| 201KD07J | 200(180~220) | 130 | 170 | 10 | 340 | 1750 | 17 | 25 | 0.25 | 250 |
| 221KD07 | 220(198~242) | 140 | 180 | 10 | 360 | 1200 | 14 | 25 | 0.25 | 230 |
| 221KD07J | 220(198~242) | 140 | 180 | 10 | 360 | 1750 | 19 | 25 | 0.25 | 230 |

Electrical Characteristics

| Model | Varistor Voltage | Maximum Allowable Voltage | | Maximum Clamping Voltage | | Surge Current | Maximum Energy (10/1000 μ s) | Maximum Leakage Current @83% of V_{1mA} | Rated Power | Typical Capacitance (Reference) |
|----------|------------------|---------------------------|--------------|--------------------------|-----------|---------------|----------------------------------|---|-------------|---------------------------------|
| | V_{1mA} (V) | V_{AC} (V) | V_{DC} (V) | I_P (A) | V_C (V) | I (A) | E (J) | I_R (μ A) | P (W) | @1KHz (pF) |
| 241KD07 | 240(216~264) | 150 | 200 | 10 | 395 | 1200 | 15 | 25 | 0.25 | 210 |
| 241KD07J | 240(216~264) | 150 | 200 | 10 | 395 | 1750 | 21 | 25 | 0.25 | 210 |
| 271KD07 | 270(243~297) | 175 | 225 | 10 | 455 | 1200 | 18 | 25 | 0.25 | 185 |
| 271KD07J | 270(243~297) | 175 | 225 | 10 | 455 | 1750 | 24 | 25 | 0.25 | 185 |
| 301KD07 | 300(270~330) | 190 | 250 | 10 | 500 | 1200 | 20 | 25 | 0.25 | 165 |
| 301KD07J | 300(270~330) | 190 | 250 | 10 | 500 | 1750 | 26 | 25 | 0.25 | 165 |
| 331KD07 | 330(297~363) | 210 | 275 | 10 | 550 | 1200 | 23 | 25 | 0.25 | 150 |
| 331KD07J | 330(297~363) | 210 | 275 | 10 | 550 | 1750 | 28 | 25 | 0.25 | 150 |
| 361KD07 | 360(324~396) | 230 | 300 | 10 | 595 | 1200 | 24 | 25 | 0.25 | 140 |
| 361KD07J | 360(324~396) | 230 | 300 | 10 | 595 | 1750 | 32 | 25 | 0.25 | 140 |
| 391KD07 | 390(351~429) | 250 | 320 | 10 | 650 | 1200 | 26 | 25 | 0.25 | 130 |
| 391KD07J | 390(351~429) | 250 | 320 | 10 | 650 | 1750 | 35 | 25 | 0.25 | 130 |
| 431KD07 | 430(387~473) | 275 | 350 | 10 | 710 | 1200 | 28 | 25 | 0.25 | 115 |
| 431KD07J | 430(387~473) | 275 | 350 | 10 | 710 | 1750 | 40 | 25 | 0.25 | 115 |
| 471KD07 | 470(423~517) | 300 | 385 | 10 | 775 | 1200 | 29 | 25 | 0.25 | 105 |
| 471KD07J | 470(423~517) | 300 | 385 | 10 | 775 | 1750 | 42 | 25 | 0.25 | 105 |
| 511KD07 | 510(459~561) | 320 | 415 | 10 | 845 | 1200 | 31 | 25 | 0.25 | 100 |
| 511KD07J | 510(459~561) | 320 | 415 | 10 | 845 | 1750 | 45 | 25 | 0.25 | 100 |
| 561KD07 | 560(504~616) | 350 | 460 | 10 | 925 | 1200 | 35 | 25 | 0.25 | 90 |
| 561KD07J | 560(504~616) | 350 | 460 | 10 | 925 | 1750 | 49 | 25 | 0.25 | 90 |
| 621KD07 | 620(558~682) | 385 | 505 | 10 | 1025 | 1200 | 38 | 25 | 0.25 | 80 |
| 621KD07J | 620(558~682) | 385 | 505 | 10 | 1025 | 1750 | 55 | 25 | 0.25 | 80 |
| 681KD07 | 680(612~748) | 420 | 560 | 10 | 1120 | 1200 | 42 | 25 | 0.25 | 75 |
| 681KD07J | 680(612~748) | 420 | 560 | 10 | 1120 | 1750 | 60 | 25 | 0.25 | 75 |
| 751KD07 | 750(675~825) | 460 | 615 | 10 | 1240 | 1200 | 45 | 25 | 0.25 | 70 |
| 751KD07J | 750(675~825) | 460 | 615 | 10 | 1240 | 1750 | 64 | 25 | 0.25 | 70 |
| 781KD07 | 780(702~858) | 485 | 640 | 10 | 1290 | 1200 | 48 | 25 | 0.25 | 65 |
| 781KD07J | 780(702~858) | 485 | 640 | 10 | 1290 | 1750 | 69 | 25 | 0.25 | 65 |
| 821KD07 | 820(738~902) | 510 | 670 | 10 | 1355 | 1200 | 52 | 25 | 0.25 | 60 |
| 821KD07J | 820(738~902) | 510 | 670 | 10 | 1355 | 1750 | 73 | 25 | 0.25 | 60 |

Electrical Ratings

| Items | Test Condition/Description | | Requirement | |
|------------------------------------|--|--------------|--|--------------|
| Varistor Voltage | The voltage between two terminals with the specified measuring current 1mA.DC applied is called Vb. | | To meet the Specified value | |
| Maximum Allowable Voltage | The recommended maximum sine wave voltage (RMS) or the Maximum DC voltage can be applied continuously. | | | |
| Maximum Clamping Voltage | The maximum voltage between two terminals with the specification standard impulse current. Applied waveform: 8/20µs | | | |
| Surge Current | The maximum current within the varistor voltage change of ±10% with the standard impulse current (8/20µs) applied one time. | | | |
| Energy | The maximum energy within the varistor voltage change of ±10% when one impulse of 10/1000µs is applied. | | | |
| Leakage Current | The current through the varistor when 0.83V _{1mA} is applied to both end. | | | |
| Rated Power | The maximum average power that can be applied within the specified ambient temperature. | | | |
| Varistor Voltage Temp. Coefficient | $\left \frac{V_{1mA@85^{\circ}C} - V_{1mA@25^{\circ}C}}{V_{1mA@25^{\circ}C}} \times \frac{1}{60} \times 100\% (\%/^{\circ}C) \right $ | | ≤0.05%/°C | |
| | $\left \frac{V_{1mA@-40^{\circ}C} - V_{1mA@25^{\circ}C}}{V_{1mA@25^{\circ}C}} \times \frac{1}{65} \times 100\% (\%/^{\circ}C) \right $ | | | |
| Surge Life | The change of V _{1mA} shall be measured after the impulse listed below which is applied 10,000 times continuously with the interval of ten seconds at room temperature. | | ΔV _{1mA} /V _{1mA} ≤10% | |
| | 07D series | 180K to 680K | | 25A (8/20µs) |
| | | 820K to 821K | | 50A (8/20µs) |

Mechanical Characteristics and Reliability

| Items | Test conditions / Methods | | Specifications | |
|-------------------------------|---|------------------|---|--|
| Tensile Strength of Terminals | Gradually applying the force specified and keeping the unit fixed for 10±1 sec. | | No visible damage $ \Delta V_{1mA}/V_{1mA} \leq 5\%$ | |
| | Terminal diameter (mm) | Force (kg) | | |
| | 0.5<d≤0.8 | 1.0 | | |
| | 0.8<d≤1.25 | 2.0 | | |
| Bending Strength of Terminals | Hold specimen and apply the force specified below to each lead. Bend the specimen to 90°, then return to the original position. Repeat the procedure in the opposite direction. | | No visible damage $ \Delta V_{1mA}/V_{1mA} \leq 5\%$ | |
| | Terminal diameter (mm) | Force (kg) | | |
| | 0.5<d≤0.8 | 0.5 | | |
| | 0.8<d≤1.25 | 1.0 | | |
| Vibration | Frequency range: 10~55 Hz Amplitude: 0.75mm or 98m/s ² Direction: 3 mutually perpendicular directions, 2hrs each. | | No visible damage $ \Delta V_{1mA}/V_{1mA} \leq 5\%$ | |
| | Solder Temp: 245±5°C Dipping Time: 2±0.5 sec | | | |
| Solder ability | Solder Temp: 245±5°C Dipping Time: 2±0.5 sec | | At least 95% of terminal electrode is covered by new solder | |
| Resistance to Soldering Heat | Solder Temp: 260±5°C Dipping Time: 10±1 sec | | No visible damage $ \Delta V_{1mA}/V_{1mA} \leq 10\%$ | |
| High Temperature Storage | Ambient Temp: 125±2°C Duration: 1000hrs | | $ \Delta V_{1mA}/V_{1mA} \leq 5\%$ | |
| Low Temperature Storage | Ambient Temp: -40±2°C Duration: 1000hrs | | $ \Delta V_{1mA}/V_{1mA} \leq 5\%$ | |
| Humidity | Ambient Temp: 40±2°C, 90~95% R.H. Duration: 1000hrs | | $ \Delta V_{1mA}/V_{1mA} \leq 5\%$ | |
| Temperature Cycle | The conditions shown below shall be repeated 5 cycles | | | No visible damage $ \Delta V_{1mA}/V_{1mA} \leq 5\%$ |
| | Step | Temperature (°C) | Period (minutes) | |
| | 1 | -40±3 | 30±3 | |
| | 2 | Room temperature | 15±3 | |
| | 3 | 125±3 | 30±3 | |
| High Temperature Load | Ambient Temp: 85±2°C Duration: 1000hrs Load: Max. Allowable Voltage In AC eara. | | $ \Delta V_{1mA}/V_{1mA} \leq 10\%$ | |
| | Ambient Temp: 40±2°C, 90~95% R.H. Duration: 1000hrs Load: Max. Allowable Voltage | | | |
| Damp Heat Load | Ambient Temp: 40±2°C, 90~95% R.H. Duration: 1000hrs Load: Max. Allowable Voltage | | No visible damage $ \Delta V_{1mA}/V_{1mA} \leq 10\%$ | |
| Voltage Proof | Metal balls method, 2500Vac 1 min. | | No visible damage | |

Soldering Recommendation

Wave Lead Free Soldering Recommendation

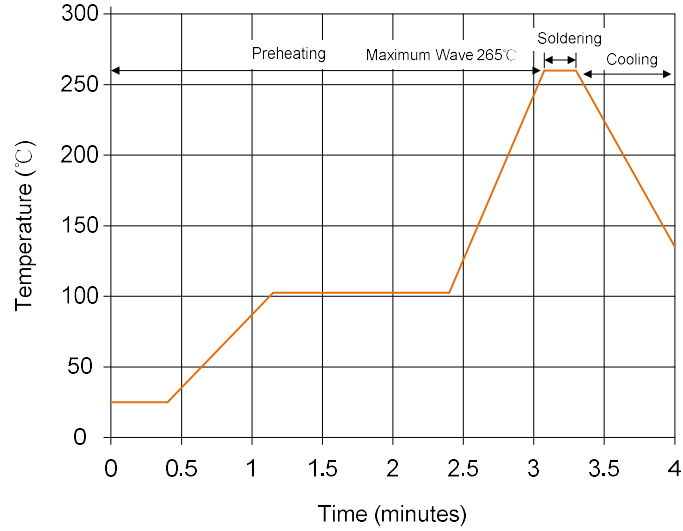

Peak Temperature: 265°C
 Dipping Time: 10 seconds (max.)
 Soldering: 1 time

Recommendation Reworking Conditions with Soldering Iron

Temperature of Soldering Iron-tip: 360°C (max.)
 Soldering Time: 3 seconds (max.)
 Distance from Varistor: 2mm (min.)

Power Derating Curve

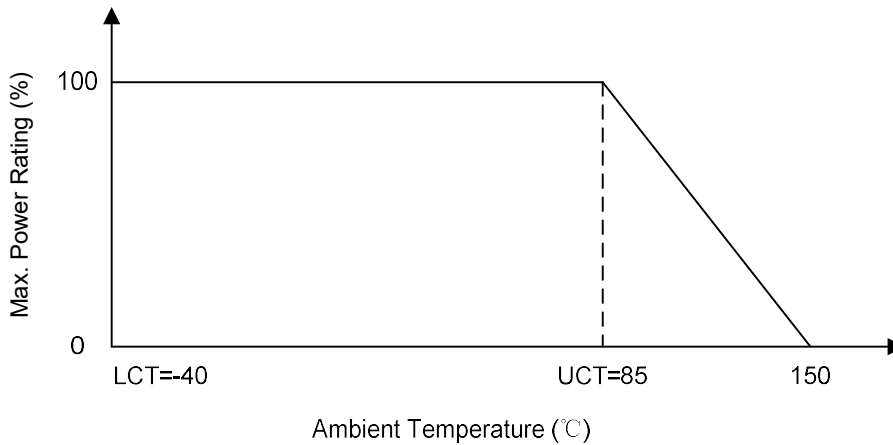

Maximum Surge Current Derating Curve

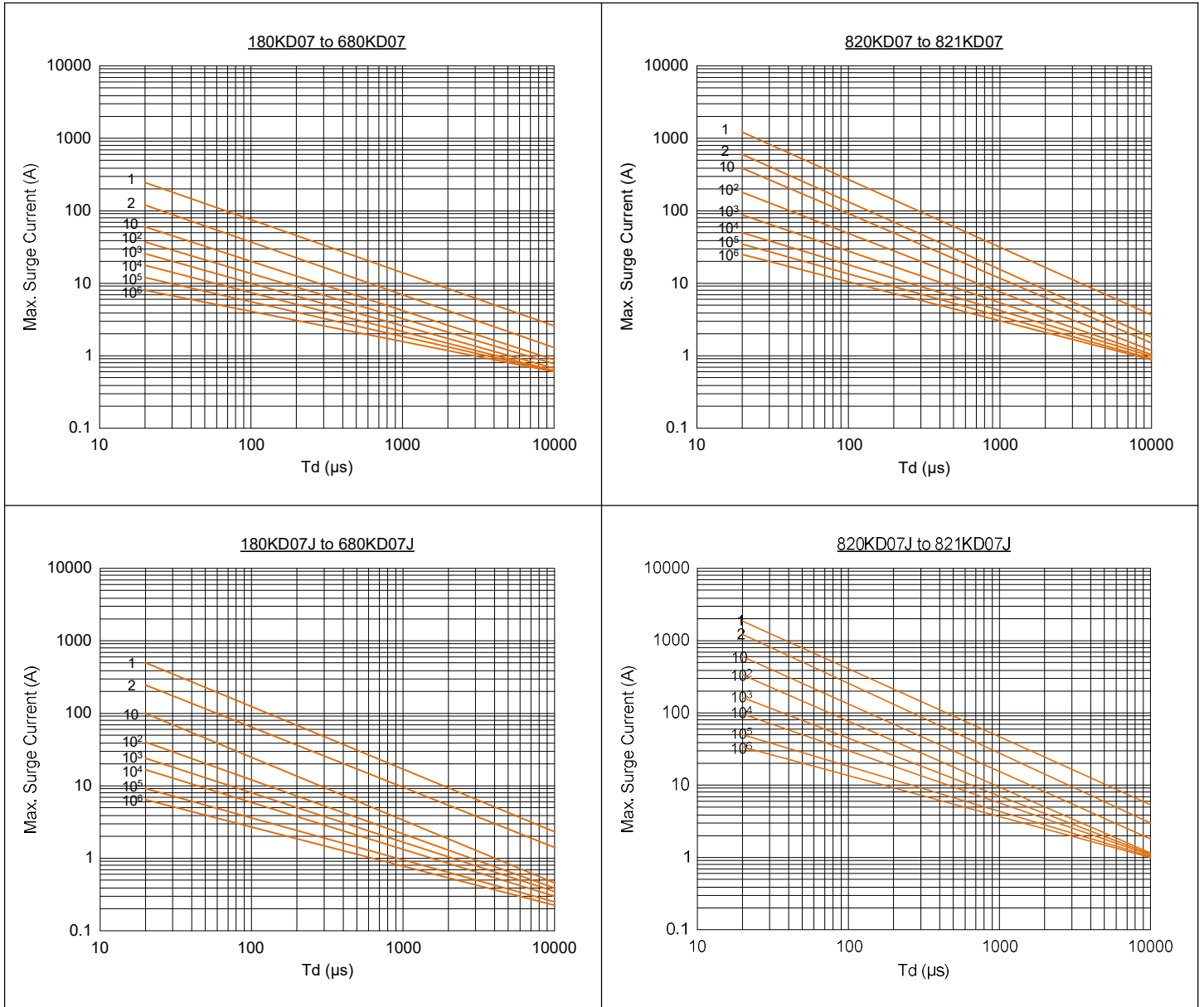

Maximum Leakage Current and Maximum Clamping Voltage Curve

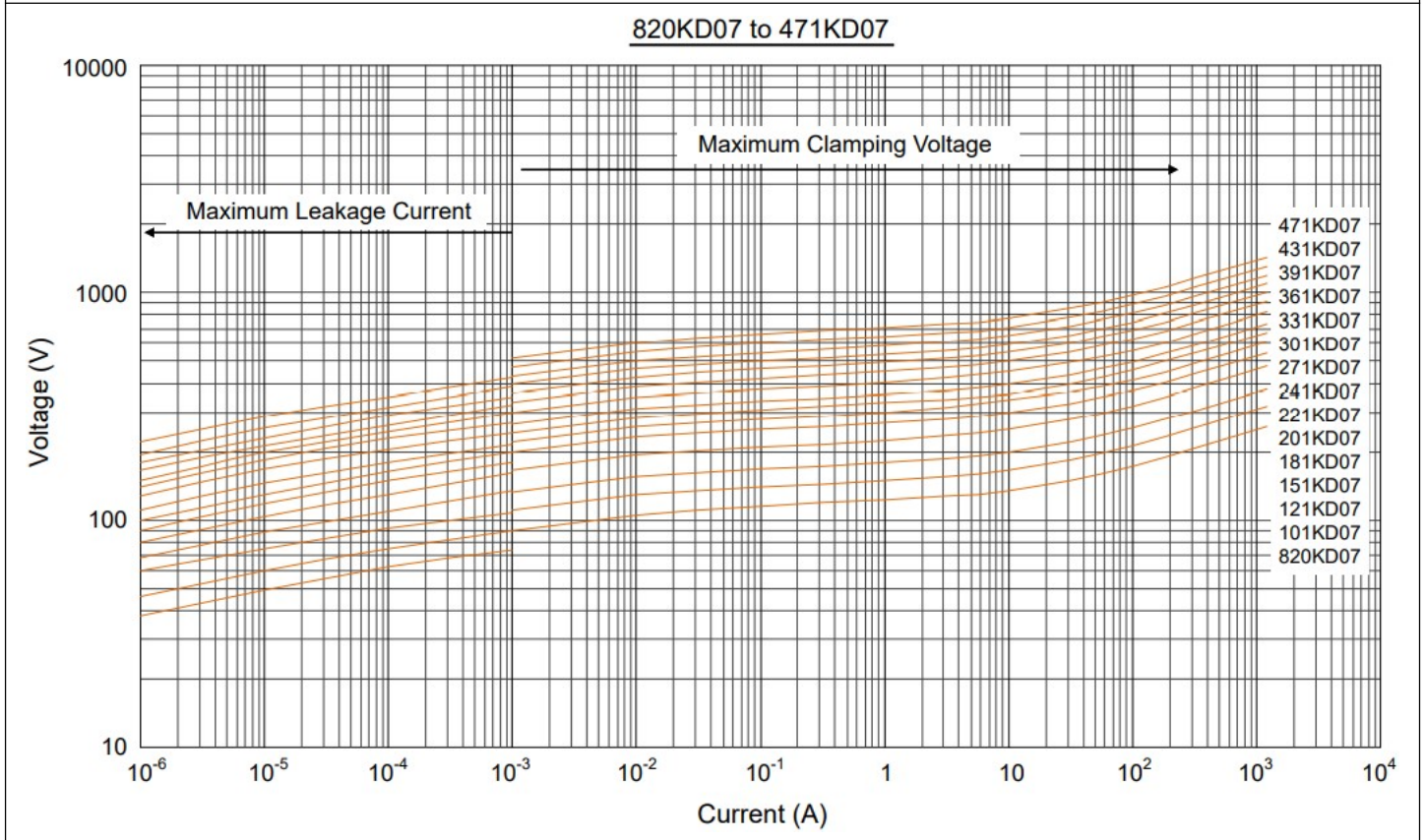
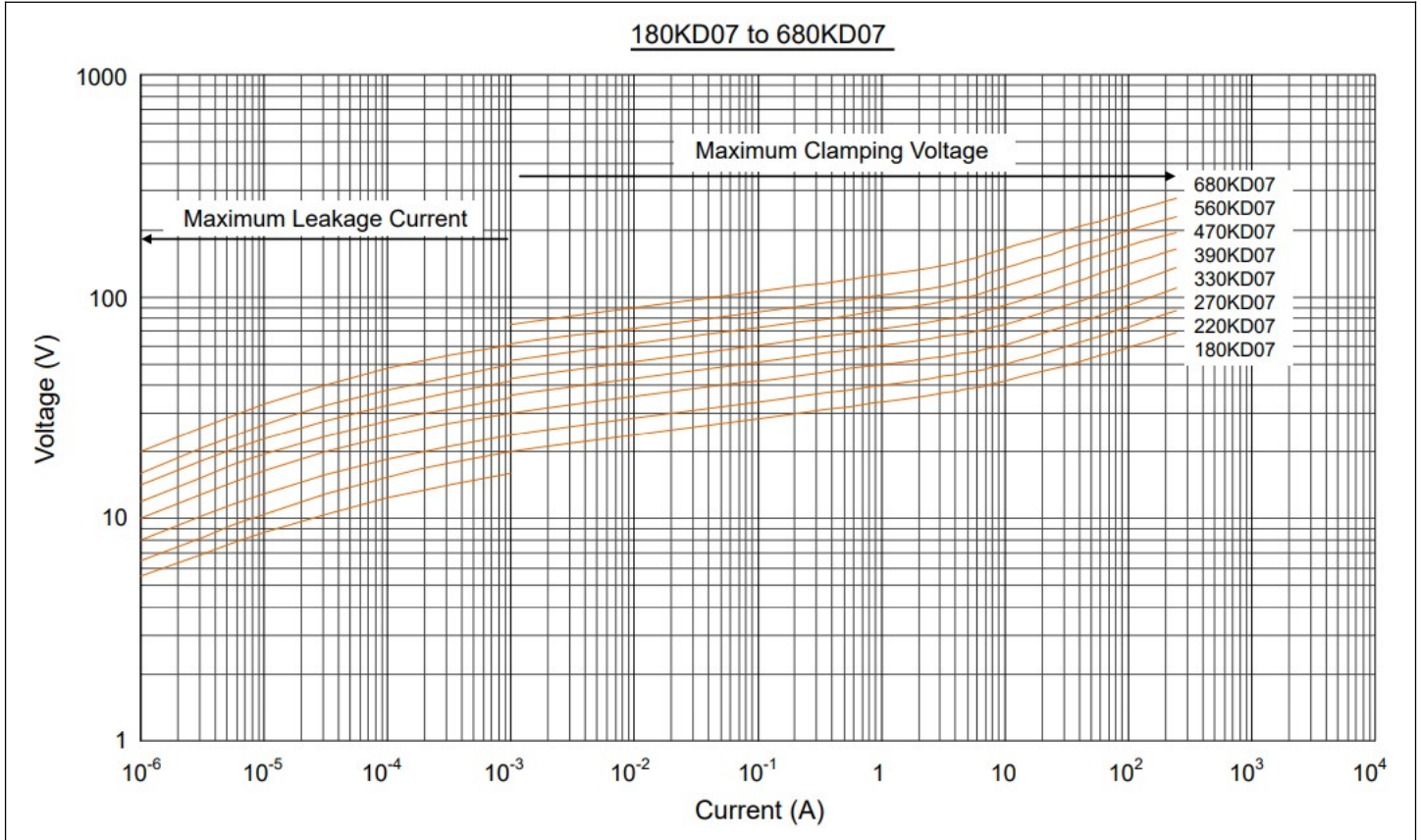

Maximum Leakage Current and Maximum Clamping Voltage Curve

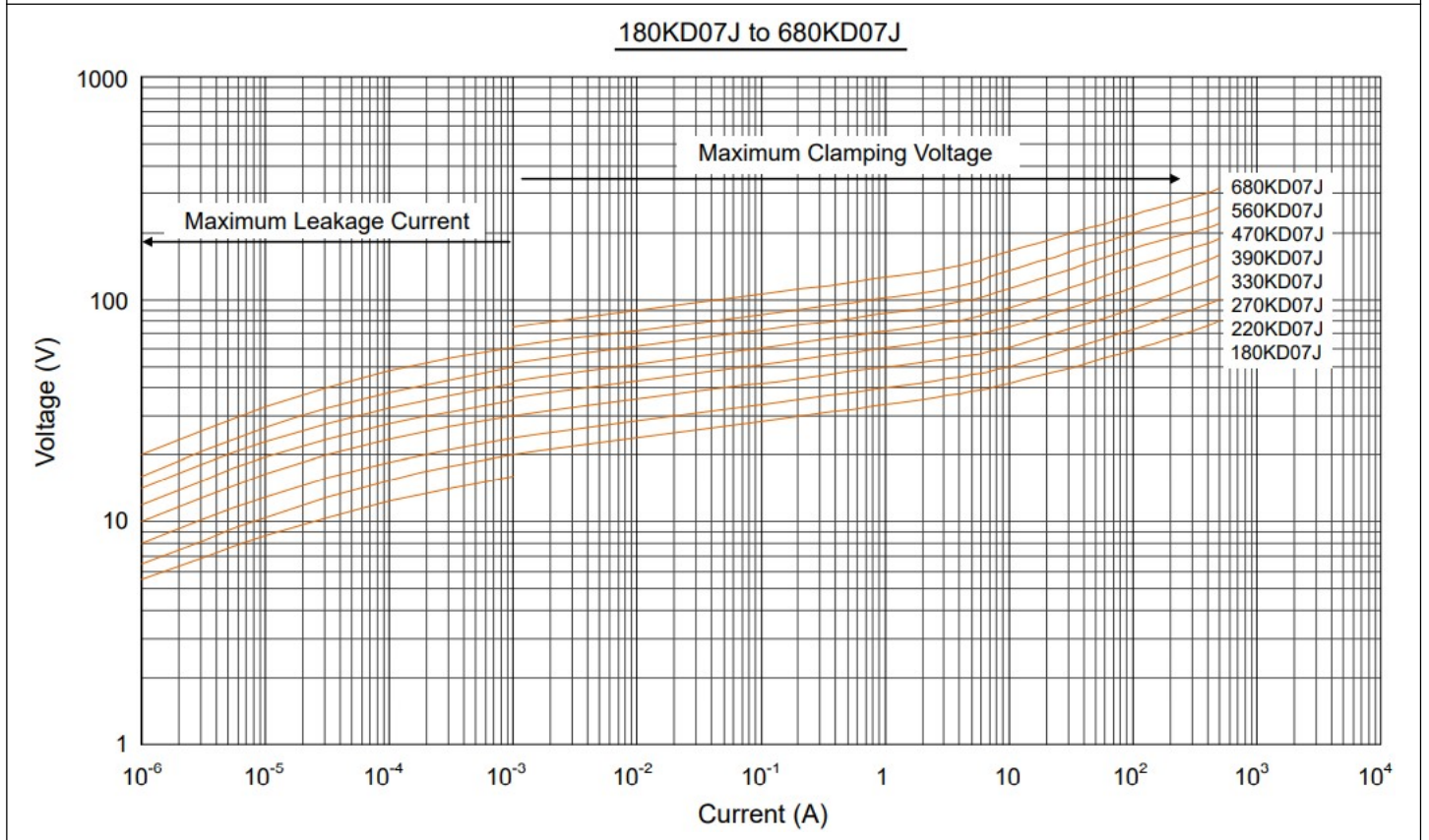
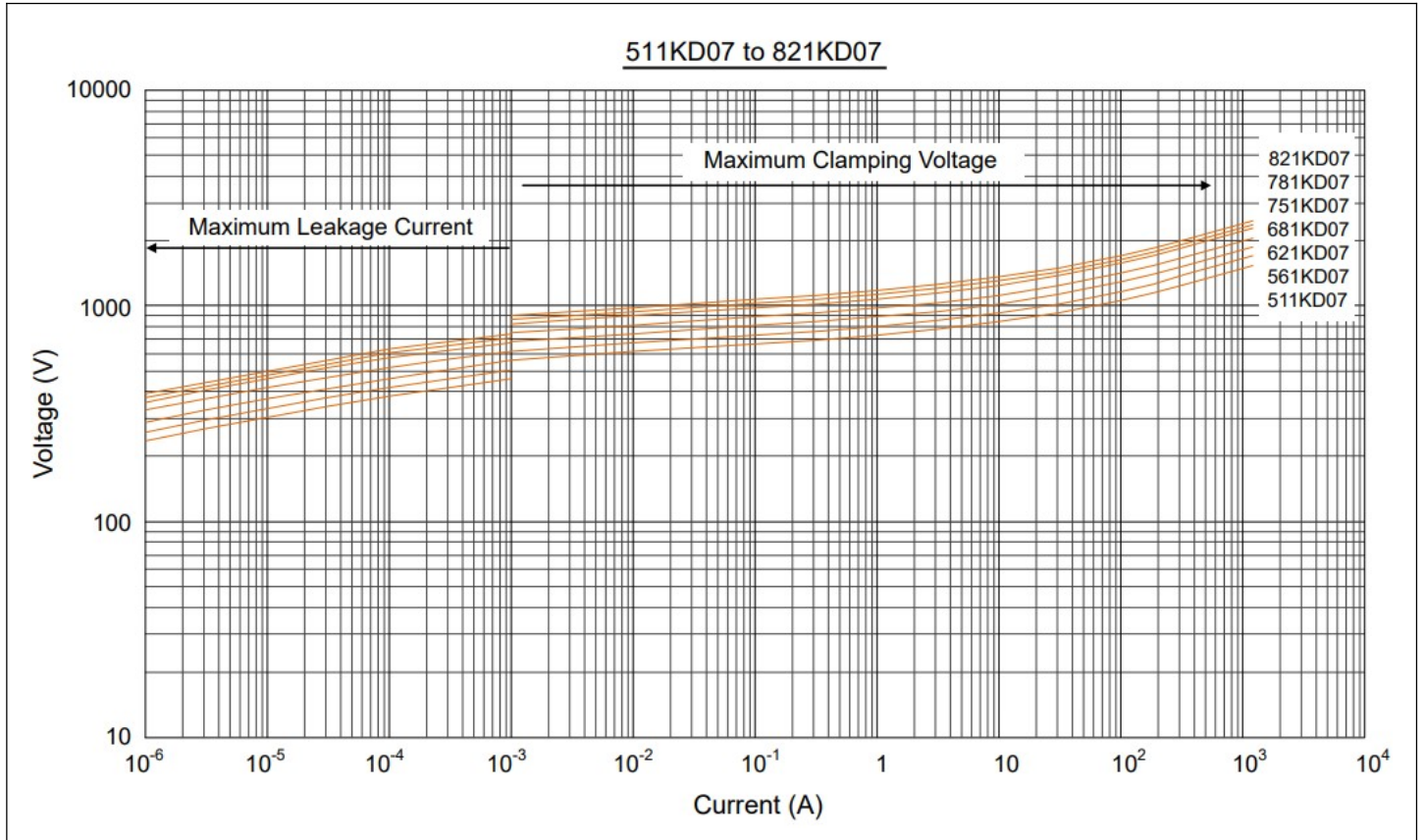

Maximum Leakage Current and Maximum Clamping Voltage Curve

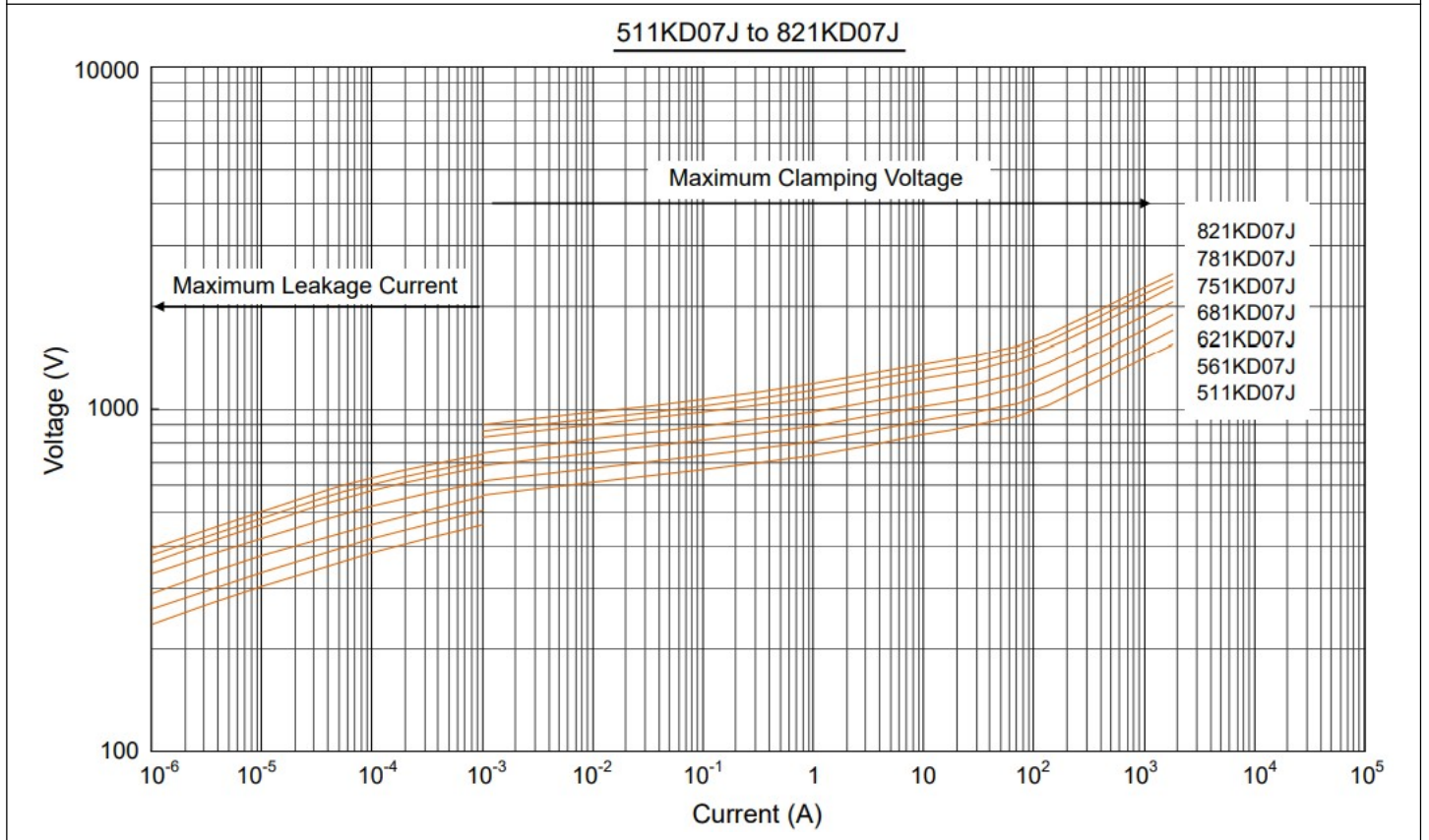
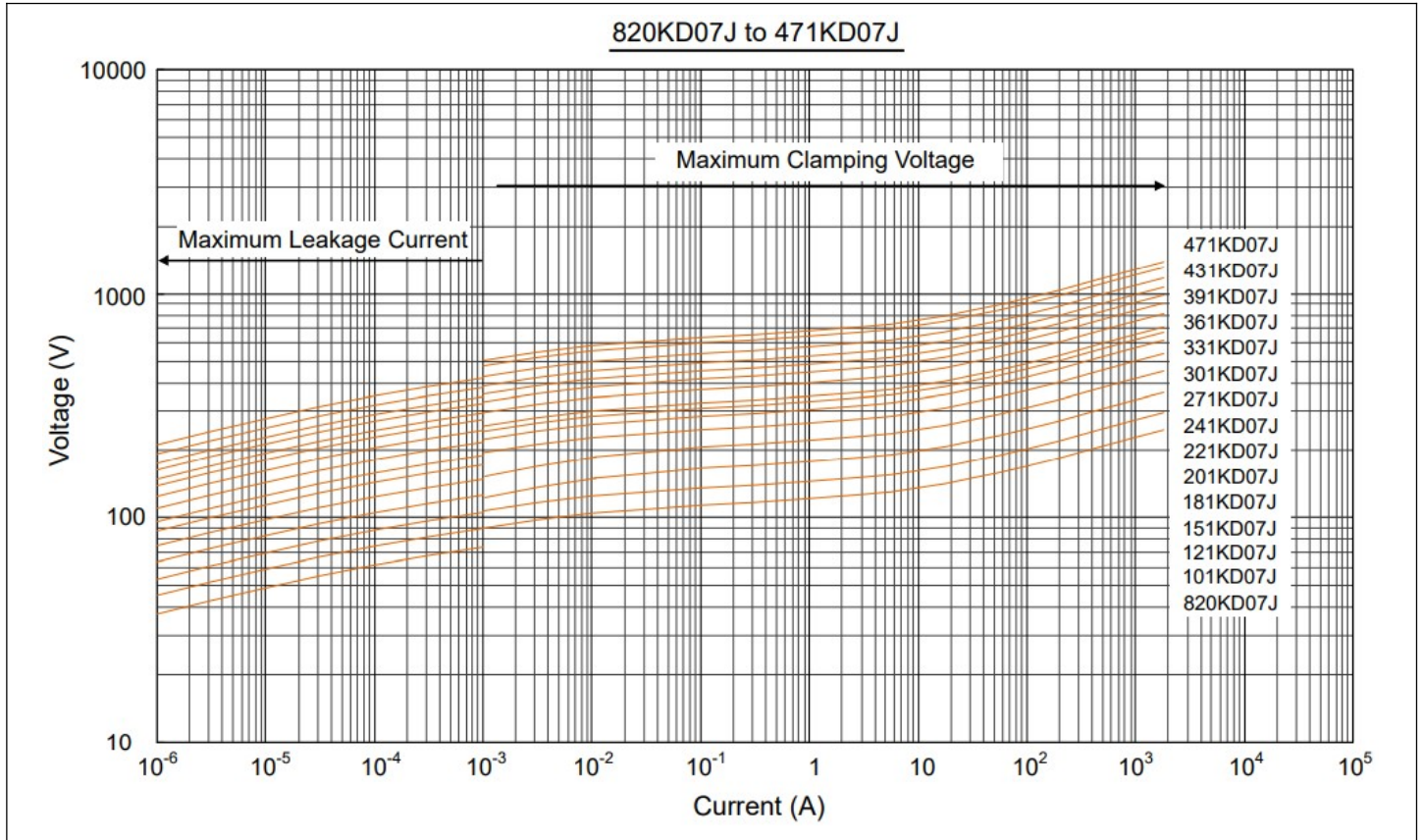

Taping Packaging

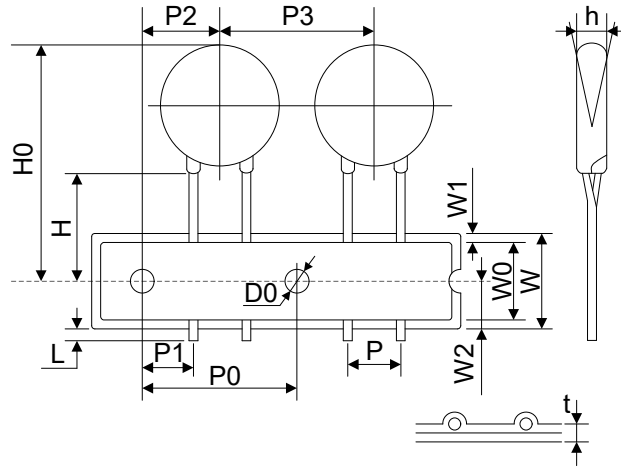

| | | | | | | | | |
|----------------|---------|----------|----------|----------|----------|----------|----------|---------|
| Item | P | P0 | P1 | P2 | P3 | W | W0 | W1 |
| Dimensions(mm) | 5.0±0.8 | 12.7±0.3 | 3.85±0.7 | 6.35±1.3 | 12.7±1.0 | 18.0±1.0 | 12.0±1.0 | 3.0max. |
| Item | W2 | H | H0 | D0 | L | h | t | |
| Dimensions(mm) | 9.0±0.5 | 20.0±2.0 | 32max. | 4.0±0.2 | 1.0max. | 0±2 | 0.6±0.3 | |

Tape & Box

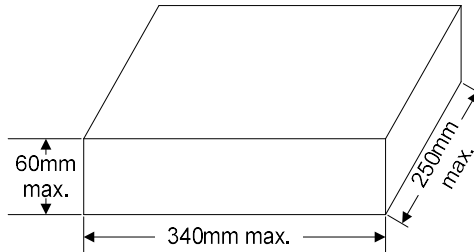

Tape & Reel

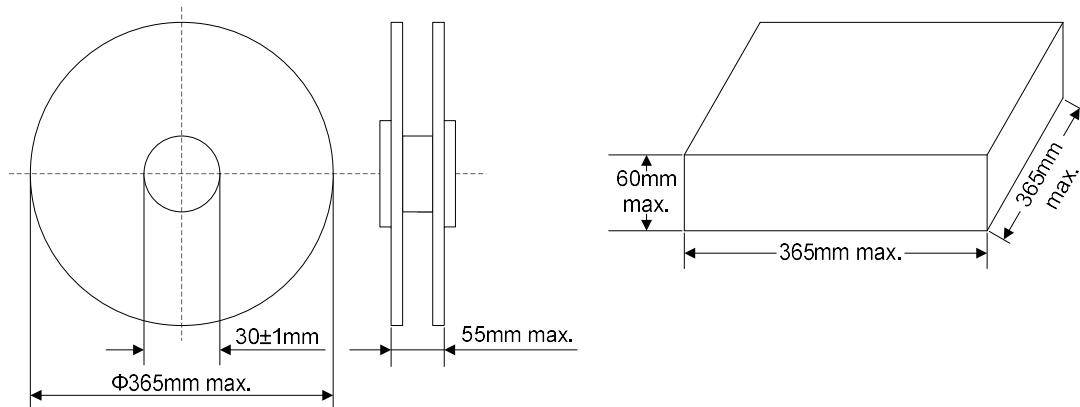

Quantity

| Packaging | Model | Quantity | |
|-------------|-----------|--------------|------------|
| Bulk | 180K~821K | 1000pcs/bag | 2 bags/box |
| Tape & Box | 180K~391K | 1500pcs/box | / |
| | 431K~681K | 1000pcs/box | / |
| | 751K~821K | 750pcs/box | / |
| Tape & Reel | 180K~331K | 2000pcs/reel | 1 reel/box |
| | 361K~821K | 1500pcs/reel | 1 reel/box |