

CUSTOMER:

DATE: December 09,2021

SPECIFICATION

DESCRIPTION: Aluminium Electrolytic Capacitors

AISHI P/N: ELH2WM151Q25KT

SERIES: LH

ITEM: 450 V 150 μ F (Φ 30 \times 25)

CUSTOMER P/N:

No.: CRS-NJ-21120906

APPROVED BY

Please Return One Copy with Your Approval
承认后请寄回一份

PREPARED BY

CHECKED BY

APPROVED BY



CUSTOMER		SERIES	LH	DATE	2021-12-09
-----------------	--	---------------	-----------	-------------	-------------------

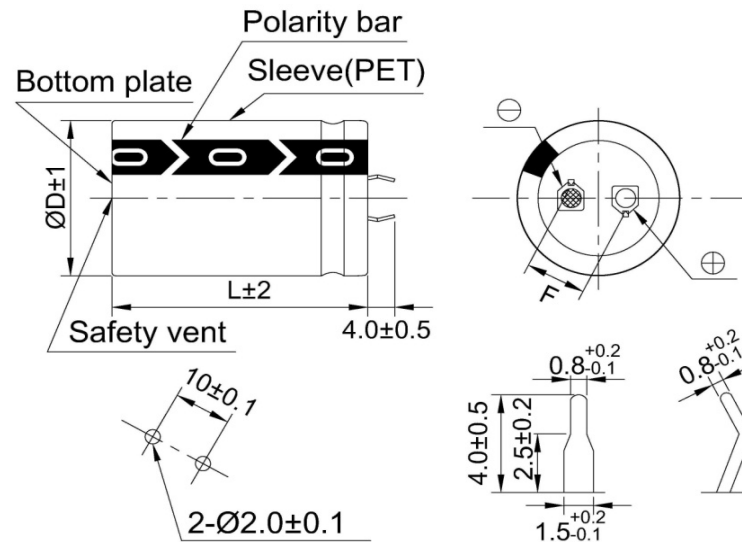

(PC board hole dimensions) (Terminal dimensions)

FIG-1

TABLE-1

No.	Customer Part No.	Aishi Part No.	Capacitance (μF)	Tolerance on Rated Capacitance (%)	Rated Voltage (Vdc)	Surge Voltage (Vdc)	Operating Temp. Range ($^{\circ}\text{C}$)	Tan δ at 20 $^{\circ}\text{C}$ 120Hz (Max)	Leakage Current (μA)(5min.)	Max Ripple Current at 105 $^{\circ}\text{C}$, 120Hz (A)	Endurance at 105 $^{\circ}\text{C}$ (Hours)	Dimensions (mm)			Appearance Drawing No.
												$\varnothing D$	L	F	
1		ELH2WM151Q25KT	150	-20~+20	450	500	-25~+105	0.15	779	0.85	2000	30	25	10	FIG-1

1 概述 SCOPE

本承认书规定了LH系列焊针引出式铝电解电容器的技术规范，本技术规范条文解释权归本公司所有。

This specification covers LH series snap-in type aluminum electrolytic capacitors. AISHI reserves the right of final interpretation for this technical specification.

2 参考标准 APPLICABLE SPECIFICATION

本承认书参考IEC 60384-1、IEC 60384-4、GB/T 2693和GB/T 5993制定。

This specification consulted the institute of IEC 60384-1, IEC 60384-4, GB/T 2693 and GB/T 5993.

3 工作温度范围 OPERATING TEMPERATURE RANGE

工作温度范围是电容器在施加额定工作电压条件下，可以长期可靠工作的环境温度范围，详见表1。

Operating temperature range is the range of ambient temperature at which the capacitor can be operated continuously at rated voltage, please see TABLE-1 for detail.

4 测试环境 CONDITION OF TEST

如果没有其他规定，标准的测试、检验环境条件如下所示：

环境温度：15℃~35℃

相对湿度：45%~75%

大气压力：86kPa~106kPa

如果对测试结果有异议，可以在以下条件测试：

环境温度：20±1℃

相对湿度：60%~67%

大气压力：86kPa~106kPa

Unless otherwise specified, the standard range of atmospheric conditions for making measurements and tests are as follows:

Ambient temperature : 15℃ to 35℃

Relative humidity : 45% to 75%

Air pressure: 86kPa to 106kPa

If there may be doubt on the results, measurements shall be made within the following limits:



Ambient temperature : 20±1℃

Relative humidity : 60% to 67%

Air pressure : 86kPa to 106kPa

File Description	Approval Sheet				
Component P/N	LH	Version	01	Page	1
STANDARD MANUAL					

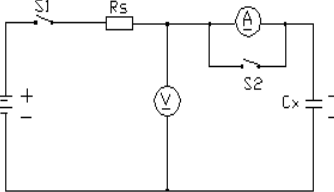
5 产品特性 PRODUCT CHARACTERISTICS
5.1 电气特性 Electrical Characteristics

序号 No.	项目 Item	测试方法 Test method	性能 Performance
5.1.1	额定工作电压 Rated voltage	电压: 直流电压值+交流电压峰值≤额定电压 Voltage: DC voltage + peak ripple voltage ≤ Rated voltage	见表1 See TABLE-1
5.1.2	电容量 Capacitance	测试频率: 120Hz(±20%) 测试电路: 串联等效 测试电压: 0.5Vrms以下+1.5~ 2.0VDC Measuring frequency: 120Hz±20% Measuring circuit: Series equivalent circuit Measuring voltage: 0.5Vrms or less +1.5 to 2.0 VDC	额定容量: 见表1
			容量偏差: 见表1
			Rated Capacitance: See TABLE-1
			Capacitance Tolerance: See TABLE-1
5.1.3	损失角正切值 Dissipation factor	测试条件与5.1.2电容量测试相同。 Testing conditions are the same as 5.1.2 for capacitance.	DF见表1 DF: See TABLE-1
5.1.4	漏电流 Leakage current	<p>在电容器两端施加额定工作电压, 并串联1000±100Ω电阻, 在施加电压5分钟后, 测量漏电流。测试电路如下图: The rated voltage shall be applied across the capacitor and its protective resistor which shall be 1000±100Ω. The leakage current shall then be measured after an electrification period of 5 min. Measurement circuit:</p>  <p>Rs: Protective resistor(1000±100Ω)  DC ammeter  DC voltmeter S1: Switch S2: Protective switch for an ammeter</p>	施加电压5分钟后, 测试漏电流不大于 $3\sqrt{CV}(\mu A)$ I: 漏电流 (μA) C: 容量 (μF) V: 额定工作电压 (V) The rated voltage shall be applied across the capacitor after 5 min. The leakage current shall be not more than $3\sqrt{CV}(\mu A)$ I: Leakage current (μA) C: Capacitance (μF) V: Rated voltage (V)

File Description	Approval Sheet				
Component P/N	LH	Version	01	Page	2
STANDARD MANUAL					

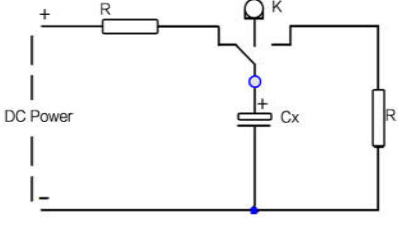
序号 No.	项目 Item	测试方法 Test method			性能 Performance
		阶段	温度	时间	
5.1.5	温度特性 Temperature Characteristic	1	20±2℃	--	阶段2: 阻抗值与阶段1阻抗值相比, 不大于表2要求。 阶段4: 容量变化应在初值的±20%范围内 Step 2: Impedance ratio to the value at step 1 shall be not more than the value given in table-2. Step 4: Capacitance change: Within ±20% of the initial value.
		2	-25 ⁺⁰ ₋₃ ℃	2h	
		3	20±2℃	15min.	
		4	105 ⁺³ ₀ ℃	2h	
		阶段1: 测量容量和阻抗 (z 20℃ 120Hz±20%) 阶段2: 电容器恒温贮存2小时, 在热平衡状态测阻抗 (z -25℃, 120Hz±20%) 阶段4: 电容器恒温贮存2小时, 在热平衡状态测电容量 Step 1:Capacitance and impedance shall be measured. (z 20℃ 120Hz±20%) Step 2:After the capacitor being stored for 2 hours, impedance shall be measured at thermal stability. (z -25℃, 120Hz±20%) Step 4:After the capacitor being stored for 105℃ 2 hours, capacitance shall be measured at thermal stability.			
5.1.6	耐浪涌电压 Surge Test	施加表1所列浪涌电压, 充电30±5秒, 放电5.5±0.5分钟作为一个周期, 共进行1000次。 测试温度: 15℃-35℃ 然后在标准大气条件下放置达到热稳定, 测试各参数 Application of DC surge Voltage stated at table-1,1000 times of charging for 30±5 sec., discharging with a period of 5.5±0.5 min.. Test temperature: 15℃-35℃ And the capacitor shall be stored under standard atmospheric conditions to obtain thermal stability, after which measurements shall be made.			容量变化: 在初始值的±15%以内。 损耗角正切值: 不大于表1规定值。 漏电流: 达到5.1.4要求 Capacitance change: With±15% of the initial value. Dissipation factor: Not more than the specified value in Table-1. Leakage current: To satisfy the requirement of No.5.1.4
		Test circuit 			Note: This requirement is only applicable to instantaneous over voltage which may be applied to terminals of capacitor, therefore, not applicable to such over voltages as often applied.

File Description	Approval Sheet				
Component P/N	LH	Version	01	Page	3
STANDARD MANUAL					

5.2机械特性 MECHANICAL PERFORMANCE

序号 No.	项目 Item	测试方法 Test method	性能 Performance
5.2.1	端子强度 Terminal strength	1. 端子抗拉伸强度 Tensile strength of termination: 电容器本身固定, 沿电容器端子引出方向慢慢施加20N拉力10±1秒钟。 A tensile force of 20N shall be applied to the terminals in the axial direction and acting in a direction away from the body for 10±1 sec. 2. 端子抗弯曲强度 Bending strength of terminals: 在端子承受力最弱处(距端子引出方向1.6mm处), 沿垂直方向逐渐施加25N拉力, 并保持30±5秒钟然后用力一次性将端子扳回到原位。 Apply tensile force of 25N on terminals in the weakest direction gradually, after reached to the specified tensile force, keep it for 30±5 sec. Apply tensile force in the opposite direction with the same way. Carry out this operation once.	测量电容器应无接触不良、开路或短路, 无可见机械损伤。 When the capacitors is measured, there shall be no intermittent contacts, or open or short-circuiting. There shall be no visible mechanical damage.
5.2.2	振动试验 Resistance to Vibration	在3个互相垂直的方向分别施加2小时振动, 共6小时 频率: 10~55Hz 全振幅: 1.5mm 振速: 1分钟内振速10~55~10Hz Direction and duration of vibration: 3 orthogonal directions mutually each for 2h, total 6h. Vibration Frequency Range:10~55Hz Peak to peak amplitude: 1.5mm Sweep rate:10 to 55 to10Hz in about 1 min	测量电容器应无接触不良开路或短路, 无可见机械损伤。 When the capacitors is measured. There shall be no intermittent contacts, or open or short-circuiting There shall be no such mechanical damage.
5.2.3	可焊性 Solderability	焊锡温度: 235±5℃ 浸入时间: 2±0.5秒 Temperature of solder: 235±5℃ Dipping time: 2±0.5sec. This specification shall be met after the capacitors are stored under standard atmospheric conditions for 6 months.	浸入焊锡的引线表面积约90%以上应附著新锡。 At least 90% of circumferential surface of the dipping portion of terminal shall be covered with new solder.

File Description	Approval Sheet				
Component P/N	LH	Version	01	Page	4
STANDARD MANUAL					

5.3 耐久性测试 ENDURANCE PERFORMANCE

序号 No.	项目 Item	测试方法 Test method	性能 Performance
5.3.1	耐焊接热 Resistance to soldering heat	焊槽法: 焊锡温度: 260±5℃ 浸入时间: 10±1秒 浸入深度: 至引线根部1.5~2.0mm Solder bath method: Solder bath temperature : 260±5℃ Immersion time : 10±1sec. Depth of immersion: up to 1.5~2.0mm from the root of the lead wire covered with thermal screen.	容量变化: 在初始值±10%范围内 损失角正切值: 满足表1要求 漏电流: 满足5.1.4要求 外观: 无异状 Capacitance change: Within ±10% of the initial value . Dissipation factor: To satisfy the requirement in Table 1. Leakage current: To satisfy the requirement of No.5.1.4 Appearance: No remarkable abnormality.
5.3.2	稳态湿热 Resistance to damp heat (Steady state)	试验温度: 40±2℃ 试验时间: 500±8h 相对湿度: 90~95% 试验后, 电容器在标准大气条件下1~2小时, 然后测试参数 Test temperature : 40±2℃ Test time: 500±8h Relative humidity: 90~95% After completion of test, the capacitor shall be subjected to standard atmospheric conditions for 1 to 2 hours, after which measurements shall be made.	容量变化: 在初始值±15%范围内 损失角正切值: 满足表1要求 漏电流: 满足5.1.4要求 外观: 无异状 Variation of capacitance: Within ±15% of the initial value Dissipation factor: To satisfy the requirement in Table 1. Leakage current: To satisfy the requirement of No.5.1.4 Appearance: No remarkable abnormality.
5.3.3	高温负荷试验 Load life test	1. 试验温度: 105±2℃, 施加额定电压和额定纹波电流 Application of the rated voltage and the rated ripple current, Test temperature: 105±2℃ 2. 试验时间: 参照TABLE-1寿命要求。 Testing time: refer to TABLE-1 life requirements.	容量变化: 在初始值±20%范围内 损失角正切值: 不超过表1所列规定值的200% 漏电流: 满足5.1.4需求 外观: 无异状 Variation of capacitance: Within ±20% of the initial value. Dissipation factor: Not more than 200% of the specified value in Table 1. Leakage current: To satisfy No.5.1.4 Appearance: No remarkable abnormality.

File Description	Approval Sheet				
Component P/N	LH	Version	01	Page	5
STANDARD MANUAL					

序号 No.	项目 Item	测试方法 Test method	性能 Performance						
5.3.4	高温贮存试验 Shelf life test	在105 ±2℃环境下无负荷贮存1000 ⁺⁴⁸ ₀ h, 至少恢复16小时后。 The capacitors are stored without voltage load at 105 ±2℃ for 1000 ⁺⁴⁸ ₀ h and then resumed 16 hours.	容量变化: 初始值±20%范围内。 损失角正切值: 不超过表1所列规定值的150%。 漏电流: 不超过规定值的200%。 外观: 无异状 Variation of capacitance: Within±20% of the value before test. Dissipation factor: Not more than 150% of the specified value in Table 1. Leakage current: Not more than 200% of the specified value. Appearance: No remarkable abnormality.						
5.3.5	防爆试验 Safety vent	施加反向直流电流。 Apply a reverse voltage with DC current. <table border="1" style="margin-left: 20px;"> <thead> <tr> <th>壳号 Size</th> <th>逆向电流 Inverse current</th> </tr> </thead> <tbody> <tr> <td>≤Φ22</td> <td>1A</td> </tr> <tr> <td>>Φ22</td> <td>10A</td> </tr> </tbody> </table>	壳号 Size	逆向电流 Inverse current	≤Φ22	1A	>Φ22	10A	当防爆阀动作时, 电容器应无打火、击穿、燃烧等现象。如果防爆阀30分钟未动作, 则认为产品合格。 When the vent operated, the capacitor shall not flame although gas discharge or expulsion of a part of the inside element is allowable. If the vent does not operate with the voltage applied for 30 minutes, the test is considered to be passed.
壳号 Size	逆向电流 Inverse current								
≤Φ22	1A								
>Φ22	10A								

※ 表2 (TABLE 2)

阻抗比 Max. Impedance Ratio	额定工作电压 Rated voltage (v)	10	16	25	35	50	63	80	100	160~250	315~500
	z -25℃/ z 20℃	4	4	3	3	2	2	2	2	4	8
	z -40℃/ z 20℃	15	15	10	8	6	6	5	5	-	-

File Description	Approval Sheet				
Component P/N	LH	Version	01	Page	6
STANDARD MANUAL					

6 标记MARKING

6.1在电容器体上应注明如下内容:

- | | | |
|------------|---|---|
| (1) 生产厂商商标 |  | |
| (2) 负极标志 | -- V | |
| (3) 工作电压 | -- μF | |
| (4) 标称容量 | LH | |
| (5) 系列 | eg:25/105/21 | (25表示工作下限温度-25度, 105表示工作上限温度+105度, 21表示稳态湿热试验21天) |
| (6) 额定温度 | eg: CE 1501 | (15表示年份的最后两位,01表示制造年周) |

The following items shall be marked indelibly on the capacitor.

- | | | |
|-------------------------|---|---|
| (1) Brand |  | |
| (2) Polarity | -- V | |
| (3) Rated voltage | -- μF | |
| (4) Nominal capacitance | LH | |
| (5) Series | eg:25/105/21 | Lower limit working temperature -25℃, upper limit working temperature +105℃, resistance to damp heat (Steady state) test time 21days. |
| (6) Rated temperature | eg: CE 1501 | (15 means the last two digits of the manufacture year and 01 means the manufacture week.) |

6.2 标记颜色Marking color

- 套管颜色: 黑色
 标记颜色: 白色
 Sleeve color: Black
 Marking color: White

7 纹波电流频率因子RIPPLE CURRENT FREQUENCY COEFFICIENT

Freq. (Hz) VV(Vdc)	50/60	100/120	300	1k	10k	100k
10~50	0.95	1.00	1.03	1.03	1.05	1.08
63~100	0.92	1.00	1.07	1.07	1.13	1.19
160~250	0.81	1.00	1.17	1.32	1.45	1.50
315~500	0.77	1.00	1.16	1.30	1.41	1.43

File Description	Approval Sheet				
Component P/N	LH	Version	01	Page	7
STANDARD MANUAL					

8 物料编码 PART NO. SYSTEM

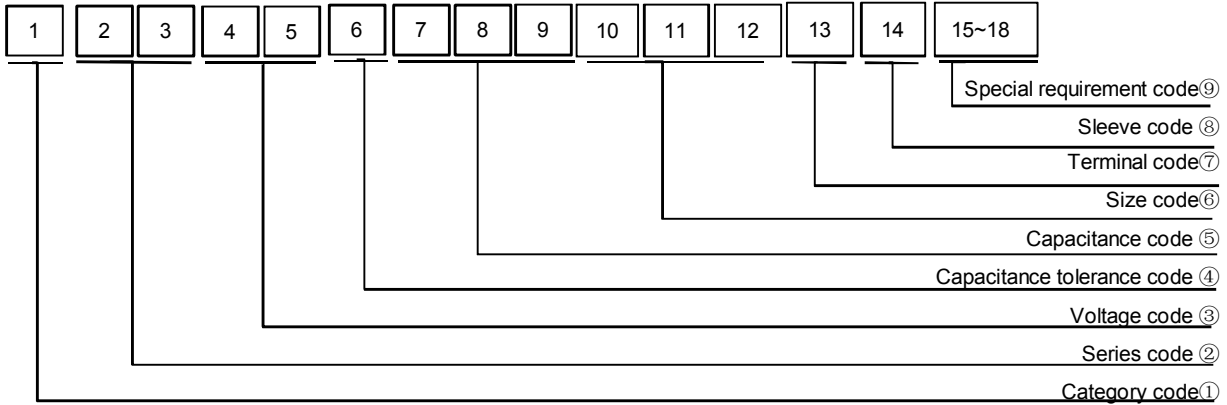

① Category code

Type	Code
Electrolytic Capacitor	E

② Series code

Series name	Code
LH	LH

③ Voltage code

WV (V)	Code
10	1A
16	1C
25	1E
35	1V
50	1H
63	1J
80	1B
100	1K
160	2C
180	2L
200	2D
220	2N
250	2E
315	2F
350	2V
360	2R
380	2P
400	2G
420	2T
450	2W
500	2H
550	2J
600	2K

④ Capacitance tolerance code

Tol.(%)	Code
-10~+10	K
-20~+20	M
-10~+30	Q
-5~+15	T
-10~+20	V
0~+20	A
-5~+20	C
-10~-20	B
-5~+5	D
0~+10	E
-5~-20	F
-15~+5	N

⑦ Terminal code

Specification	Code
2-pin snap-in terminals (6.0 mm length)	B(lock)
	J(unlock)
2-pin snap-in terminals (4.0 mm length)	K(lock)
	A(unlock)
左弯Horizontal mounting terminal left	M
右弯Horizontal mounting terminal right	R
U型脚U type terminal	U
L型焊片Lug Terminal	L
三脚3-pin terminals (4.0 mm length)	T(lock)
	C(unlock)
4-pin snap-in terminals (6.3 mm length)	E(lock)
	Q(unlock)
4-pin snap-in terminals (4.5 mm length)	D(lock)
	P(unlock)
五脚Five pin terminals	Y
闪光灯焊片 Lug Terminal for photo flash	F

⑤ Capacitance code

Cap (μF)	Code
22	220
33	330
47	470
68	680
100	101
180	181
220	221
270	271
330	331
470	471
560	561
820	821
1000	102
1200	122
1500	152
1800	182
2200	222
2700	272
3300	332
3900	392
4700	472
5600	562
8200	822
10000	103
12000	123
15000	153
18000	183
22000	223
27000	273
33000	333
39000	393
47000	473
56000	563
68000	683

⑥ Size code (ΦD)

ΦD	Code
22	O
25	P
30	Q
35	R
40	Y
45	I

⑥ Size code (L)

L(mm)	Code
20	20
25	25
30	30
35	35
40	40
45	45
50	50
60	60
80	80
100	A0

⑧ Sleeve code

Sleeve	Code
PVC	C
PET	T

⑨ Special requirement code

File Description	Approval Sheet				
Component P/N	LH	Version	01	Page	8
STANDARD MANUAL					

9 包装PACKING

9.1 包装按下图包装方式

Bulk packing capacitors are packed into inner BOX and cartons according to the following drawing.

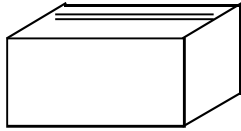

内盒
inner box

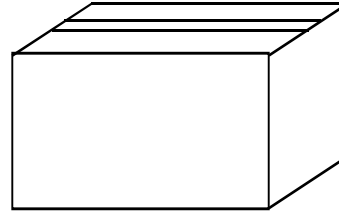

外盒
carton

10 其它说明 OTHER REMARKS

10.1 铝电解电容器使用注意事项

IMPORTANT INFORMATION ON THE APPLICATION OF ALUMINUM ELECTROLYTIC CAPACITORS

(1) 直流铝电解电容器应按正确的极性使用 DC electrolytic capacitors are polarized

当直流铝电解电容器按反极性接入电路时，电容器会导致电子线路短路，由此产生的电流会引致电容器损坏。若电路中有可能在负引线施加正电压，请选无极性产品。

When reverse voltage is applied to DC aluminium electrolytic capacitors, the circuit will be short out because of the improper application and the capacitors will be damaged due to abnormal current flows through the capacitors. Please use non-polar types of capacitors when the positive voltage is applied on the cathode terminal.

(2) 在额定工作电压以下作用 Use capacitor within rated voltage

当电容器上所施加电压高于额定工作电压时，电容器的漏电流将上升，其电气特性将在短时期内劣化损坏。请注意电压峰值勿超出额定工作电压。

When capacitor is used at a higher voltage than the rated voltage, leakage current may increase and electrical characteristics may be deteriorated and damaged in a short period of time. Please take extra caution that the peak voltage should not exceed the rated voltage.

(3) 作快速充放电使用 Rapid charge and discharge application

当常规电容器被用作快速充电用途，其使用寿命可能会因为容量下降，温度急剧上升等而缩减。

When aluminum electrolytic capacitors for general purpose-use are employed in rapid charge and discharge application, its life expectancy may be shortened by capacitance decrease, heat rise, etc.

(4) 电容器贮存 Storage of the capacitors

① 请保管在室温5~35℃，湿度75%以下的环境。

we recommend the following conditions for storage: Ambient temperature: 5~35℃, Ambient humidity: <75%RH;

a) 产品储存期限: ≤12个月; Storage life: ≤ 12 months;

b) 产品储存期限>12个月时，需充电后再使用;

If storage life > 12 months, the products need to be charged again before using;

c) 存放时间超过3年的电解电容器应报废处理;

If Storage time > three years, the products need to be discarded;

d) 库存有效期以产品套管上印刷的时间开始计算;

Expiry Date: calculating from the date marked on the sleeve;

e) 请尽量以包装状态保管; Please keep capacitors in the original package;

f) 请避免在以下环境下保管: Avoid storing the capacitors under such circumstances:

※ 溅水、高温高湿及结露的环境。 With water and oil or damp & dewing location.

※ 溅油、或者充满气体油成分的环境。 With gas and oil.

※ 充满酸性有毒气体（硫化氢，亚硫酸，亚硝酸，氯，溴，溴化甲烷等）的环境。

With toxic gases such as hydrogen sulfide, sulfurous acid, nitrous acid, chlorine, bromine and methyl bromide.

※ 直射阳光、臭氧、紫外线及放射线照射的环境。

With direct sunlight, Ozone, ultraviolet rays or radiation.

File Description	Approval Sheet				
Component P/N	LH	Version	01	Page	9
STANDARD MANUAL					

②当铝电解电容器作了长期贮存后，其漏电流通常升高，贮存温度愈高，漏电流上升愈快。因此应注意贮存环境，在电容器上施加电压后，漏电流值将不断下降，如铝电解电容器的漏电流值上升对电路有不良影响，请在使用前充电处理。

Increased leakage current is commonly seen in aluminum electrolytic capacitors which have been stored for a long period of time. The Higher the storage temperature is, the faster the leakage current rises. Therefore please pay attention to the storage environment. The leakage current decreases gradually as voltage is applied to the capacitor. As increased leakage current may cause problems in the circuit, please apply voltage (aging) before using.

(5)施加纹波电流应小于额定值 **Ripple current applied to capacitor should not exceed the rated value**

施加纹波电流超过额定值后，会导致电容器体过热，容量下降，寿命缩短。所施加纹波电压的峰值应小于额定工作电压。

If excessive ripple current is applied to the capacitor, excessive heat will be generated inside, the capacitance will be reduced and capacitor's life may be shortened. The peak value of the ripple voltage should be less than the rated voltage.

(6)使用环境温度 **Ambient temperature**

铝电解电容器的使用寿命会受到环境温度的影响。据科学统计，使用环境温度下降10℃其使用寿命增加1倍。

Life of aluminium electrolytic capacitor is affected by the ambient temperature. It is generally known that the life doubles for each 10℃ decrease in ambient temperature.

(7)引出线强度 **Lead stress**

当拉力施加到电容器引出线，该拉力将作用于电容器内部，这可能导致电容器内部短路，开路或漏电流上升。在电容器焊装到电路板，请勿强烈摇动电容器。

When a strong force is applied to the lead wires or terminals, stress is put on the internal connections. This may result in short circuit, open circuit or increased leakage current. It is not advisable to bend or handle a capacitor after it has been soldered to the PC board.

(8)焊接过程耐热性 **Heat resistance in the soldering process**

铝电解电容器装至电路板进行浸焊或波焊时，其塑料套管可能因焊接时间过长、温度过高而发生破裂或二次收缩。

In the dip soldering or wave-soldering process of PC board with aluminum electrolytic capacitors mounted, secondary shrinkage or crack of PVC sleeve may be found when solder temperature is too high or dipping time is too long.

(9)电路板的安装孔孔距及安装位置 **Hole pitch and position of PC board**

电路板安装孔的设计应与产品说明书的引线脚距相一致，如果将电容器强行插入孔距不配套的电路板，那么会有应力作用于引出线，这可能导致短路或漏电流上升。

A PCB board must be designed so its hole pitch coincides with the lead pitch (lead spacing) of the capacitor as specified by the catalog or specifications. When a capacitor is forcibly inserted into a PCB with unmatched hole pitch, stress will be put on the leads, which may result in short circuit or increased leakage current.

(10) 关于焊接以后的清洗 **Cleaning after soldering**

① 电容器不能用卤化有机物系列的清洗剂进行清洗。如果必须进行清洗，请使用能够保证电容器质量的清洗剂。

The aluminum electrolyte capacitors should be free of halogenated solvents during board cleaning after soldering. Use solvent proof capacitors when halogenated solvents are used.

② 对于能够保证电容器质量的清洗剂，清洗后请不要在清洗溶液或者密封容器中保管。清洗后的电容器请和电路板一起在热风下干燥10分钟以上，热风的温度不可高于电容器规定上限温度。

After being cleaned with the cleaning agent which can guarantee the quality of capacitors, pay attention not to keep the capacitors in cleaning solution or non-ventilated places. Dry the capacitors and PCB with hot blast for above 10 mins. Note that the temperature of hot blast should not exceed the specified rated temperature of capacitors.

(11) 关于固定剂、镀层(涂层剂)以及PCB **Concerning adhesives、coating materials(coating agent) and PCB**

① 请不要使用含有卤素的固定剂、镀层(涂层剂)以及PCB。

Do not use halogen-containing adhesives, coating materials(coating agent) and PCB to fix aluminum electrolytic capacitors.

② 请不要让固定剂及镀层(涂层剂)将电容器封口部位(端子一侧)全部封住。

Do not cover up all the sealing area of capacitors with adhesives or coating materials(coating agent), make coverage only partial.

※ 电容器的防爆阀的上面，请留出以下间隙：

Make the following open space over the vent so that the vent can operate correctly:

外壳直径 Case diameter	须留间隙 Clearance
Ø6.3 to Ø16mm	≥2mm
Ø18 to Ø35mm	≥3mm
≥Ø40mm	≥5mm

10.2符合RoHS **RoHS compliance**

符合欧盟RoHS的最新标准，若客户有特殊要求，按照双方签订的相关协议为准。

Completely in accordance with the latest standard of RoHS or relevant agreements reached by both parts if customer has special requirements.

File Description	Approval Sheet				
Component P/N	LH	Version	01	Page	10
STANDARD MANUAL					