

## Features

- \* 300W peak pulse power (8/20 $\mu$ s)
- \* Protects one data or power line
- \* Ultra low leakage: nA level
- \* Operating voltage: 5V
- \* Ultra low clamping voltage
- \* Complies with following standards:
  - IEC 61000-4-2 (ESD) immunity test  
Air discharge:  $\pm 30$ kV  
Contact discharge:  $\pm 30$ kV
  - IEC61000-4-5 (Lightning) 20A (8/20 $\mu$ s)
  - IEC61000-4-4 (EFT) 40A (5/50ns)
- \* RoHS Compliant

## Mechanical Characteristics

- \* Package: SOD-323
- \* Lead Finish: Matte Tin
- \* Case Material: "Green" Molding Compound.
- \* UL Flammability Classification Rating 94V-0
- \* Moisture Sensitivity: Level 3 per J-STD-020
- \* Terminal Connections: See Diagram Below
- \* Shipping Qty :3000 /7Inch Tape & Reel

## Applications

- \* Cellular Handsets and Accessories
- \* Personal Digital Assistants
- \* Notebooks and Handhelds
- \* Portable Instrumentation
- \* Peripherals
- \* Pagers Peripherals
- \* Desktop and Servers

## Dimensions and Pin Configuration

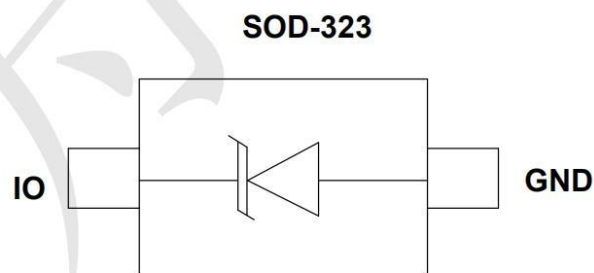

**Absolute Maximum Ratings** (Tamb=25°C unless otherwise specified)

Parameter	Symbol	Value	Unit
Peak Pulse Power (8/20μs)	Ppk	300	W
Peak Pulse Current (8/20μs)	IPP	20	A
ESD per IEC 61000-4-2 (Air)	VESD	±30	kV
ESD per IEC 61000-4-2 (Contact)		±30	
Operating Temperature Range	TJ	-55 to +125	°C
Storage Temperature Range	Tstg	-55 to +150	°C

**Electrical Characteristics** (TA=25°C unless otherwise specified)

Parameter	Symbol	Min	Typ	Max	Unit	Test Condition
Reverse Working Voltage	VRWM			3.3	V	
Breakdown Voltage	VBR	4.8			V	IT = 1mA
Reverse Leakage Current	IR			0.5	μA	VRWM = 3.3V
Forward Voltage	VF		0.8	1.2	V	IF=10mA
Clamping Voltage	VC			9	V	IPP = 1A (8 x 20μs pulse)
Clamping Voltage	VC			15	V	IPP = 20A (8 x 20μs pulse)
Junction Capacitance	CJ			200	pF	VR = 0V, f = 1MHz

**Typical Performance Characteristics (TA=25°C unless otherwise Specified)**

**Fig1. 8/20μs Pulse Waveform**

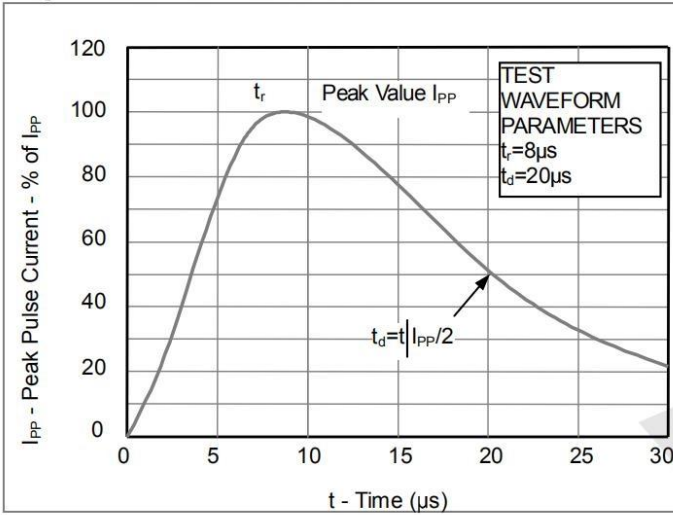

**Fig2. ESD Pulse Waveform (according to IEC 61000-4-2)**

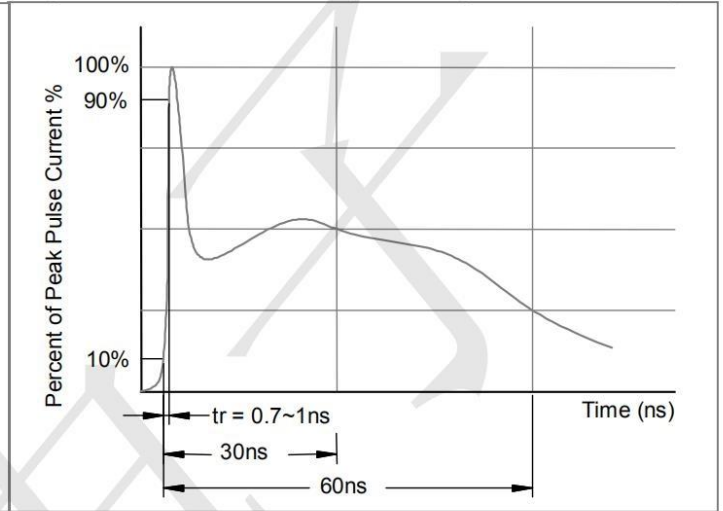

**Fig3. Power Derating Curve**

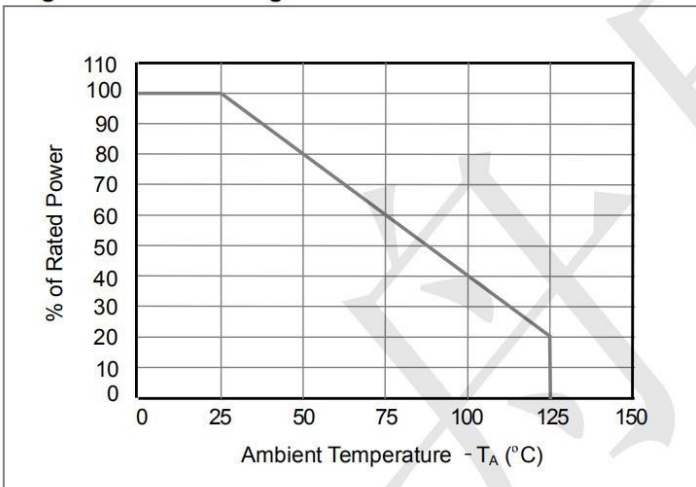

**Outline Drawing - SOD-323**

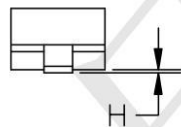
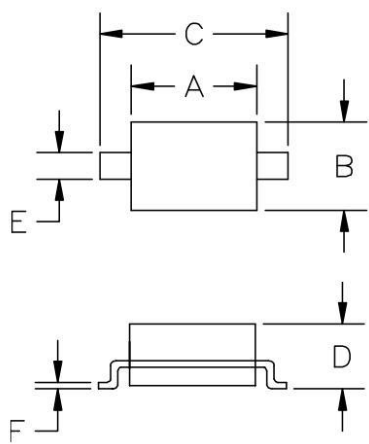

SYM	DIMENSIONS			
	MILLIMETERS		INCHES	
	MIN	MAX	MIN	MAX
A	1.50	1.80	0.060	0.071
B	1.20	1.40	0.045	0.054
C	2.30	2.70	0.090	0.107
D	-	1.10	-	0.043
E	0.30	0.40	0.012	0.016
F	0.10	0.25	0.004	0.010
H	-	0.10	-	0.004

**Land Pattern - SOD-323**

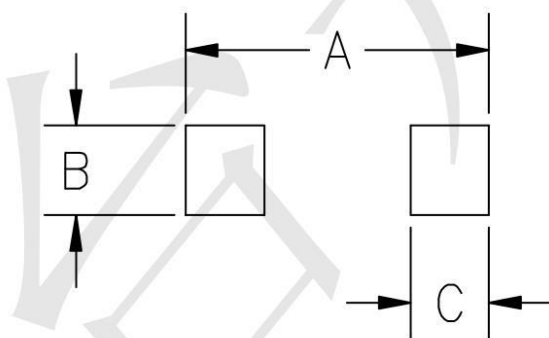

SYM	DIMENSIONS	
	MILLIMETERS	INCHES
A	3.15	0.120
B	0.80	0.031
C	0.80	0.031