

AP7N10K

N-Channel Enhancement Mosfet

AIIPOWER

DATA SHEET

Feature

- 100V,7A
 $R_{DS(ON)} < 130m\Omega @ V_{GS}=10V$ TYP:105 m Ω
 $R_{DS(ON)} < 185m\Omega @ V_{GS}=4.5V$ TYP:150 m Ω
- Advanced Trench Technology
- Lead free product is acquired
- Excellent $R_{DS(ON)}$ and Low Gate Charge

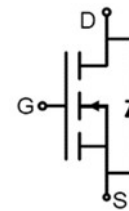

Schematic Diagram



Marking and pin Assignment

Application

- PWM applications
- Load Switch
- Power management

Package Marking and Ordering Information

Device Marking	Device	Device Package	Reel Size	Tape width	Quantity (PCS)
AP7N10K	AP7N10K	TO-252	13 inch	-	2500

ABSOLUTE MAXIMUM RATINGS ($T_a=25^{\circ}C$ unless otherwise noted)

Parameter	Symbol	Value	Unit
Drain-Source Voltage	V_{DS}	100	V
Gate-Source Voltage	V_{GS}	± 20	V
Continuous Drain Current ($T_a=25^{\circ}C$)	I_D	7	A
Continuous Drain Current ($T_a=100^{\circ}C$)	I_D	4.6	A
Pulsed Drain Current ⁽¹⁾	I_{DM}	28	A
Singel Pulsed Avalanche Energy ⁽²⁾	E_{AS}	3.2	mJ
Power Dissipation	P_D	29.4	W
Thermal Resistance from Junction to Case	$R_{\theta JC}$	4.25	$^{\circ}C/W$
Junction Temperature	T_J	150	$^{\circ}C$
Storage Temperature	T_{STG}	-55~ +150	$^{\circ}C$

MOSFET ELECTRICAL CHARACTERISTICS ($T_a=25^\circ\text{C}$ unless otherwise noted)

Parameter	Symbol	Test Condition	Min	Type	Max	Unit
Static Characteristics						
Drain-source breakdown voltage	$V_{(BR)DSS}$	$V_{GS} = 0V, I_D = 250\mu A$	100	-	-	V
Zero gate voltage drain current	I_{DSS}	$V_{DS} = 100V, V_{GS} = 0V$	-	-	1	μA
Gate-body leakage current	I_{GSS}	$V_{GS} = \pm 20V, V_{DS} = 0V$	-	-	± 100	nA
Gate threshold voltage ⁽³⁾	$V_{GS(th)}$	$V_{DS} = V_{GS}, I_D = 250\mu A$	1	1.6	2.2	V
Drain-source on-resistance ⁽³⁾	$R_{DS(on)}$	$V_{GS} = 10V, I_D = 5A$	-	105	130	m Ω
		$V_{GS} = 4.5V, I_D = 3A$	-	150	185	
Forward transconductance ⁽³⁾	g_{FS}	$V_{DS} = 10V, I_D = 5A$	-	10	-	S
Dynamic characteristics						
Input Capacitance	C_{iss}	$V_{DS} = 50V, V_{GS} = 0V, f = 100kHz$	-	212	-	pF
Output Capacitance	C_{oss}		-	27.5	-	
Reverse Transfer Capacitance	C_{rss}		-	1.6	-	
Switching characteristics						
Turn-on delay time	$t_{d(on)}$	$V_{DD} = 50V, I_D = 3A, V_{GS} = 10V, R_G = 2\Omega$	-	13.2	-	ns
Turn-on rise time	t_r		-	2.2	-	
Turn-off delay time	$t_{d(off)}$		-	11	-	
Turn-off fall time	t_f		-	1.1	-	
Total Gate Charge	Q_g	$V_{DS} = 50V, I_D = 3A, V_{GS} = 10V$	-	3.3	-	nC
Gate-Source Charge	Q_{gs}		-	0.35	-	
Gate-Drain Charge	Q_{gd}		-	0.87	-	
Source-Drain Diode characteristics						
Diode Forward voltage ⁽³⁾	V_{DS}	$V_{GS} = 0V, I_S = 1A$	-	-	1.2	V
Diode Forward current ⁽⁴⁾	I_S		-	-	7	A

Notes:

1. Repetitive Rating: pulse width limited by maximum junction temperature
2. EAS Condition: $T_J = 25^\circ\text{C}, V_{DD} = 50V, R_G = 50\Omega, L = 0.5mH$
3. Pulse Test: pulse width $\leq 300\mu s$, duty cycle $\leq 2\%$
4. Surface Mounted on FR4 Board, $t \leq 10$ sec

Test Circuit

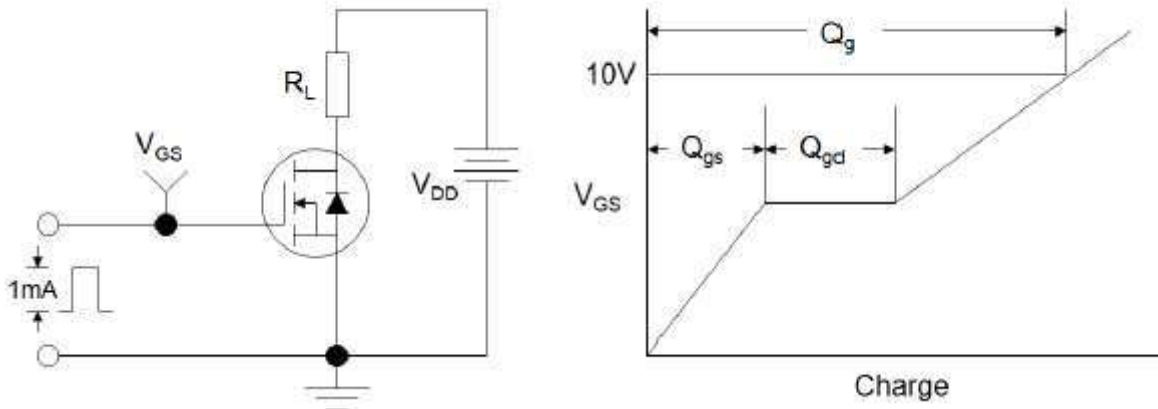

Figure1:Gate Charge Test Circuit & Waveform

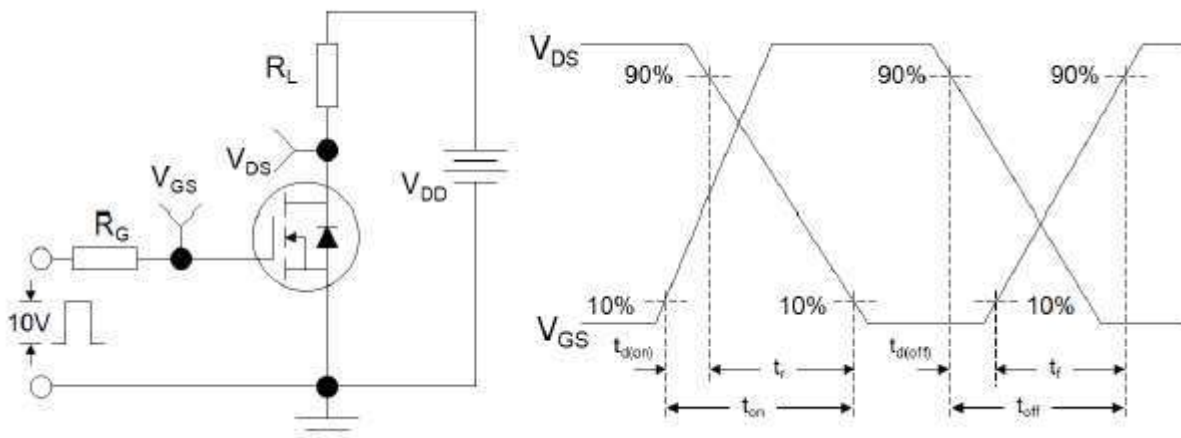

Figure 2: Resistive Switching Test Circuit & Waveforms

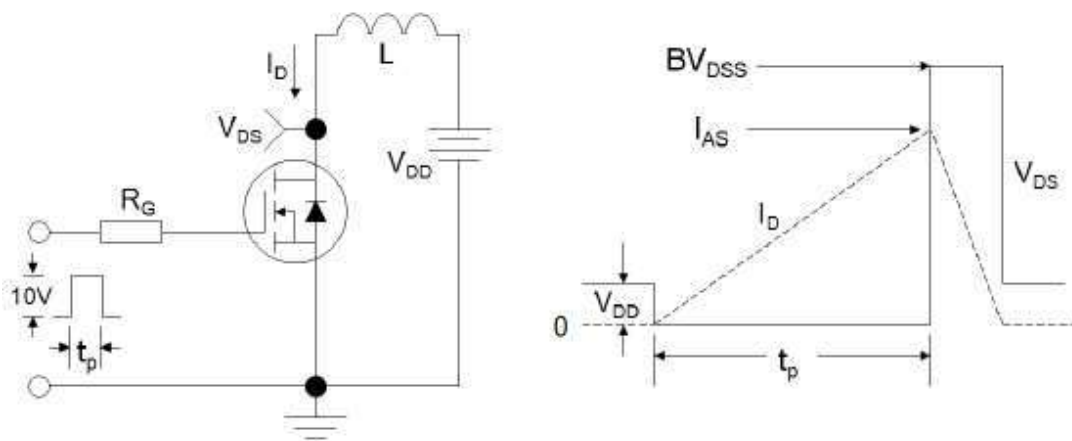

Figure 3:Unclamped Inductive Switching Test Circuit & Waveforms

Typical Performance Characteristics

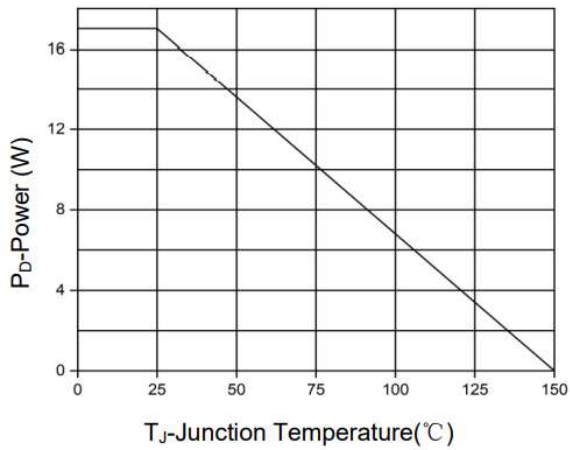

Figure 1. Power Dissipation

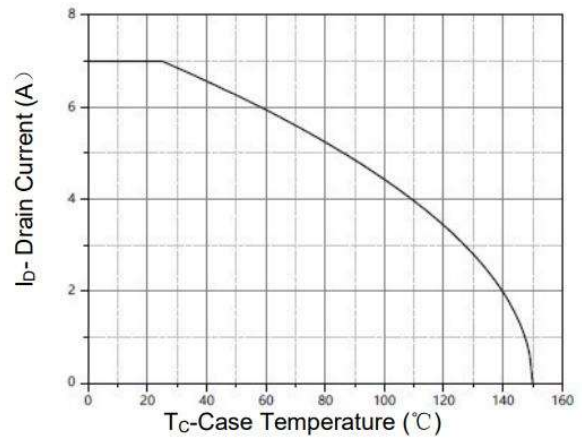

Figure 2. Drain Current

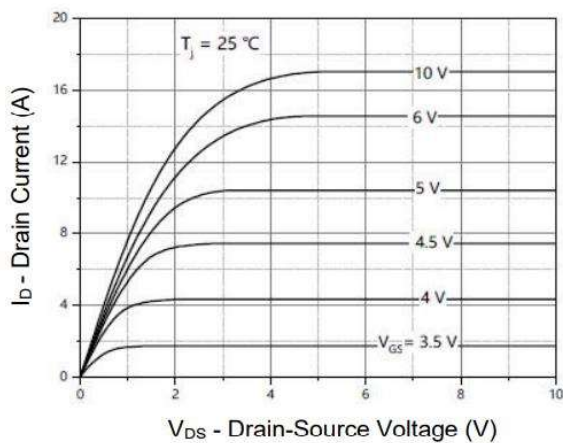

Figure 3. Output characteristics

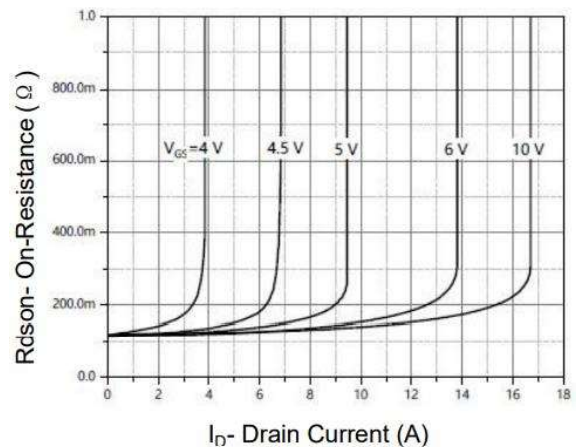

Figure 4. Drain-Source On-state resistance

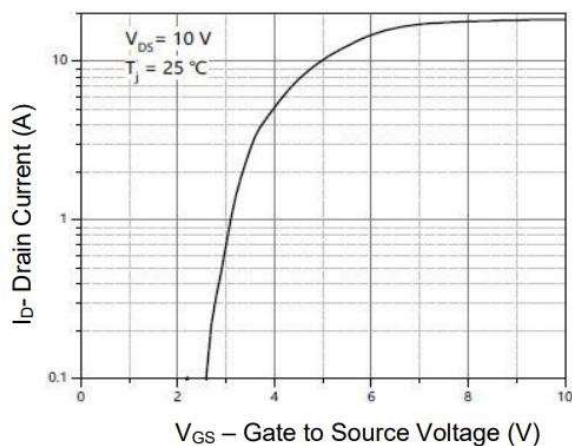

Figure 5. Transfer Characteristics

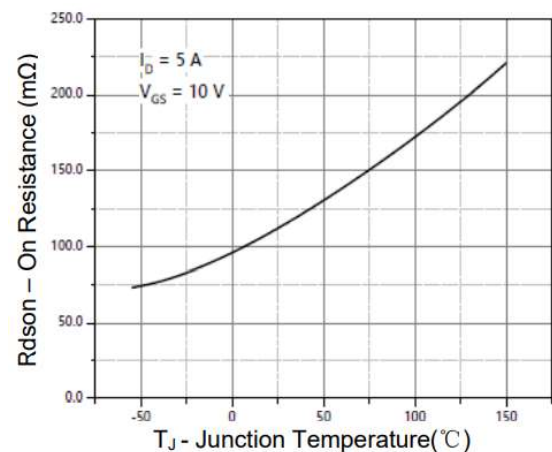

Figure 6. Drain-Source On-State Resistance

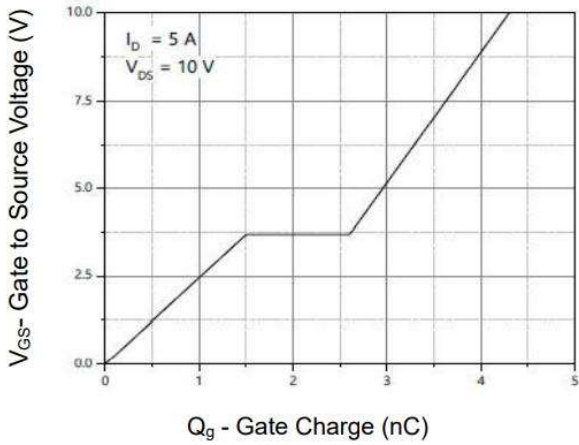

Figure 7. Gate Charge

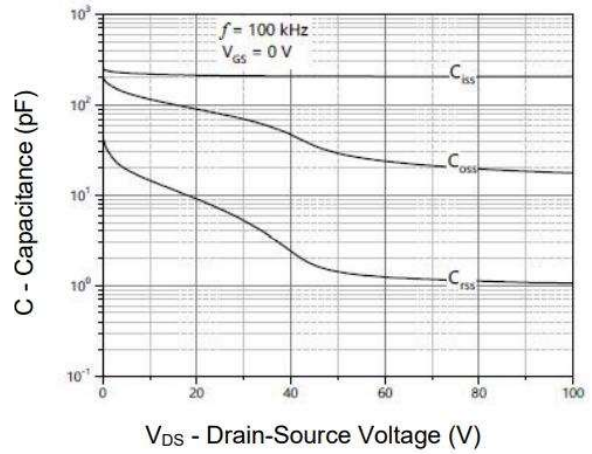

Figure 8. Capacitance vs Vds

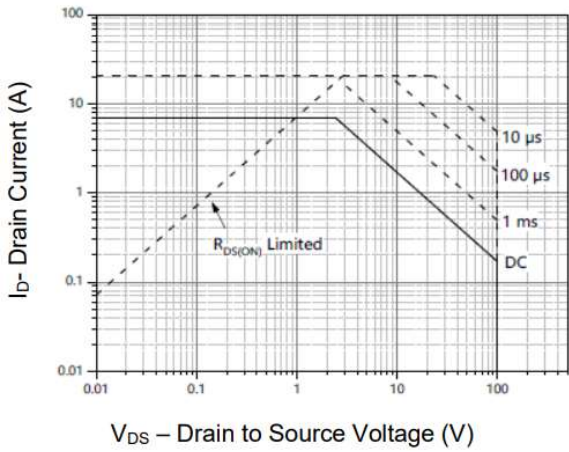

Figure 9. Safe Operation Area

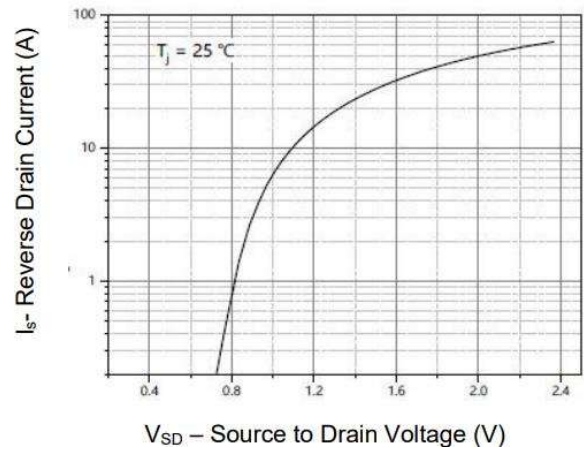

Figure 10. Source- Drain Diode Forward

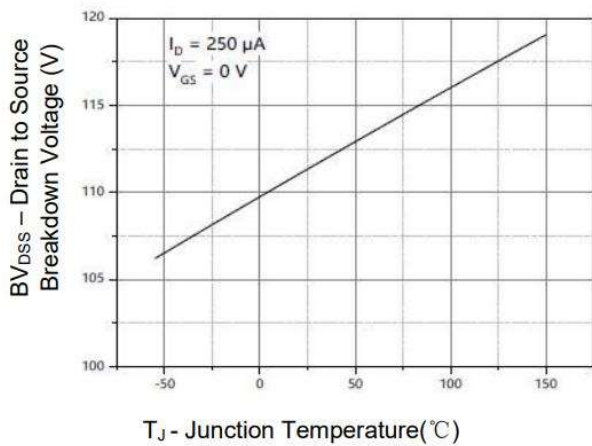
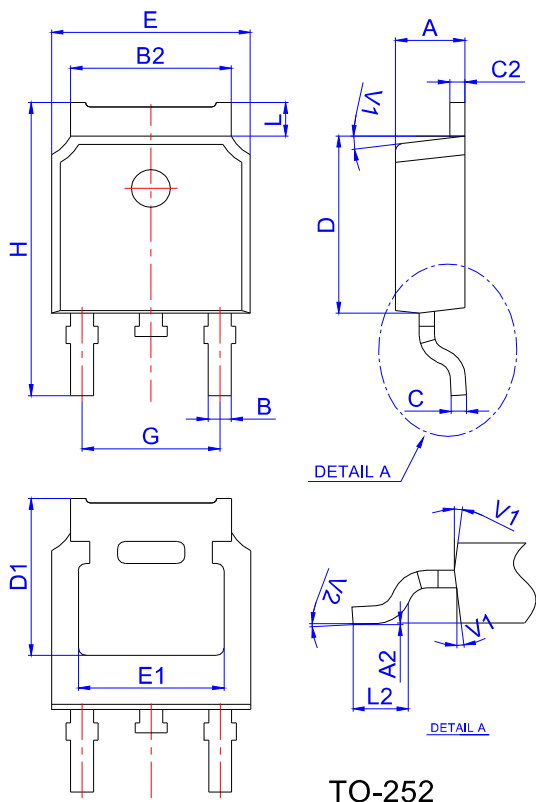

Figure 11. Drain-source breakdown voltage

Package Mechanical Data-TO-252



Ref.	Dimensions					
	Millimeters			Inches		
	Min.	Typ.	Max.	Min.	Typ.	Max.
A	2.10		2.50	0.083		0.098
A2	0		0.10	0		0.004
B	0.66		0.86	0.026		0.034
B2	5.18		5.48	0.202		0.216
C	0.40		0.60	0.016		0.024
C2	0.44		0.58	0.017		0.023
D	5.90		6.30	0.232		0.248
D1	5.30REF			0.209REF		
E	6.40		6.80	0.252		0.268
E1	4.63			0.182		
G	4.47		4.67	0.176		0.184
H	9.50		10.70	0.374		0.421
L	1.09		1.21	0.043		0.048
L2	1.35		1.65	0.053		0.065
V1		7°			7°	
V2	0°		6°	0°		6°

Reel Specification-TO-252

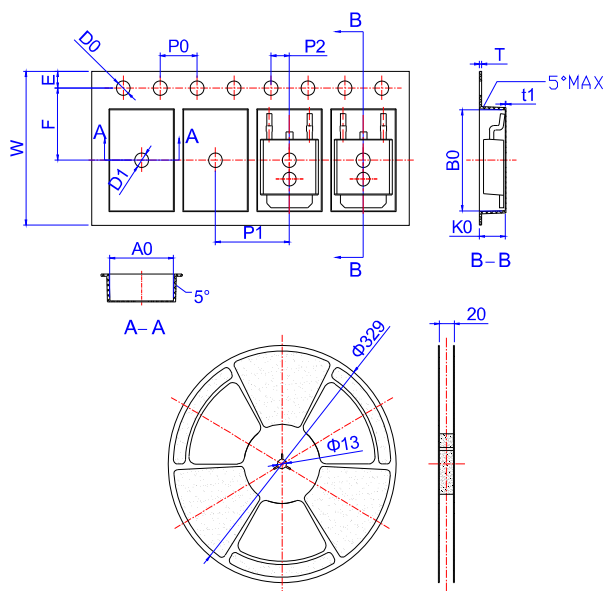

Ref.	Dimensions					
	Millimeters			Inches		
	Min.	Typ.	Max.	Min.	Typ.	Max.
W	15.90	16.00	16.10	0.626	0.630	0.634
E	1.65	1.75	1.85	0.065	0.069	0.073
F	7.40	7.50	7.60	0.291	0.295	0.299
D0	1.40	1.50	1.60	0.055	0.059	0.063
D1	1.40	1.50	1.60	0.055	0.059	0.063
P0	3.90	4.00	4.10	0.154	0.157	0.161
P1	7.90	8.00	8.10	0.311	0.315	0.319
P2	1.90	2.00	2.10	0.075	0.079	0.083
A0	6.85	6.90	7.00	0.270	0.271	0.276
B0	10.45	10.50	10.60	0.411	0.413	0.417
K0	2.68	2.78	2.88	0.105	0.109	0.113
T	0.24		0.27	0.009		0.011
t1	0.10			0.004		
10P0	39.80	40.00	40.20	1.567	1.575	1.583