

General Description

The HT72XX is a low-dropout (LDO) voltage regulator with enable function that operates from a 1.2V to 5.5V supply. It provides up to 400mA of output current in miniaturized packaging.

The feature of 2 μ A low quiescent current and 0.5 μ A shutdown current are ideal for the battery application with long service life. The other features include current limit function, over temperature protection and output discharge function.

Features

- 2 μ A Ground Current at no Load
- $\pm 2\%$ Output Accuracy
- 400mA Output Current
- 10nA Disable Current (by option)
- Wide Operating Input Voltage Range: 1.2V to 5.5V
- Dropout Voltage: 0.18V at 300mA ($V_{OUT}=3.3V$)
- Support Fixed Output Voltage 1.2V, 1.5V, 1.6V, 1.8V, 2.5V, 2.8V, 3.0V, 3.3V
- Stable with Ceramic or Tantalum Capacitor
- Current Limit Protection
- Over-Temperature Protection
- SOT23-5, SOT89-3 Packages

Applications

- Portable, Battery Powered Equipment
- Low Power Microcontrollers
- Laptop, Palmtops and PDAs
- Wireless Communication Equipment
- Audio/Video Equipment

Ordering Information

HT7233

Output voltage: 12=1.2V
15=1.5V
18=1.8V
30=3.0V
33=3.3V
XX=X.XV

PIN CONFIGURATION

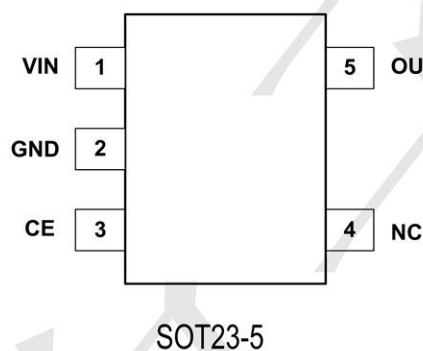
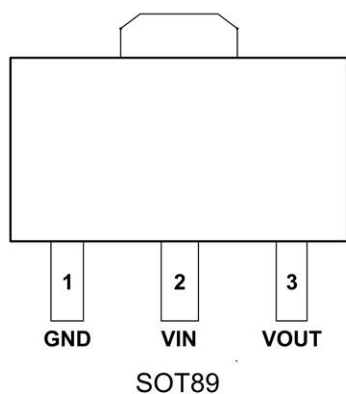

Typical Application Circuit

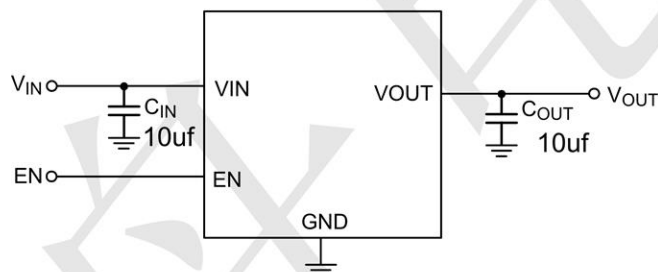

ABSOLUTE MAXIMUM RATINGS

Parameter		Value	Unit
Supply Voltage		-0.3~+6.5	V
Power Dissipation	SOT-23-5	400	mW
	SOT-89	600	mW
Thermal Resistance, Junction-to-Ambient	SOT-23-5	380	°C/W
	SOT-89	180	°C/W
Operating Junction Temperature		-40 ~ +125	°C
Storage Temperature Range		-65 ~ +150	°C
Lead Temperature (Soldering, 10 sec)		300	°C

Electrical Characteristics (T =25°C unless otherwise noted)

(V_{IN}=5V, V_{EN}=5V, T_A=25°C, unless otherwise specified) (Note 1)

PARAMETER	TEST CONDITIONS	SYMBOL	MIN.	TYP.	MAX.	UNIT
Supply Voltage		V _{IN}	1.2		5.5	V
DC Output Voltage Accuracy	I _{LOAD} =0.1mA		-2		2	%
SNS Input Current	SNS=V _{OUT}	I _{SNS}		0.5		μA
Dropout Voltage (Note 2)	I _{LOAD} =300mA, V _{OUT} ≥3V	V _{DROP_3V}		0.18		V
	I _{LOAD} =300mA, V _{OUT} =2.8V	V _{DROP_2.8V}		0.23		
	I _{LOAD} =300mA, V _{OUT} =2.5V	V _{DROP_2.5V}		0.23		
	I _{LOAD} =300mA, V _{OUT} =1.8V	V _{DROP_1.8V}		0.28		
	I _{LOAD} =300mA, V _{OUT} =1.5V	V _{DROP_1.5V}		0.36		
	I _{LOAD} =300mA, V _{OUT} =1.2V	V _{DROP_1.2V}		0.45		
GND Current	I _{LOAD} =0mA	I _Q		2		μA
Shutdown GND Current	V _{EN} =0V, V _{OUT} =0V	I _{SD}		0.1	0.5	μA
V _{OUT} Shutdown Leakage Current	V _{EN} =0V, V _{OUT} =0V	I _{LEAK}		0.1	0.5	μA
Enable Threshold Voltage	EN Rising	V _{IH}	1.0			V
	EN Falling	V _{IL}			0.4	
EN Input Current	V _{EN} =5V	I _{EN}		10	100	nA
Line Regulation	I _{LOAD} =30mA, 1.5V≤V _{IN} ≤5.5V or (V _{OUT} +0.2V)≤V _{IN} ≤5.5V	ΔLINE		0.2		%
Load Regulation	10mA≤I _{LOAD} ≤300mA	ΔLOAD		0.2		%
Output Current Limit	V _{OUT} =0V	I _{LIM}	450	500		mA
Power Supply Rejection Ratio	V _{OUT} =1.2V, I _{LOAD} =5mA, V _{IN} =2V, f=100Hz	PSRR		80		dB
	V _{OUT} =1.2V, I _{LOAD} =5mA, V _{IN} =2V, f=1kHz			75		
Output Voltage Noise	V _{IN} =3.5V, I _{LOAD} =0.1A, BW=10Hz to 100kHz, C _{OUT} =1μF, V _{OUT} =1.2V			80		μV _{RMS}
	V _{IN} =3.5V, I _{LOAD} =0.1A, BW=10Hz to 100kHz, C _{OUT} =1μF, V _{OUT} =2.8V			120		
Thermal Shutdown Temperature	I _{LOAD} =10mA	T _{SD}		155		°C
Thermal Shutdown Hysteresis	I _{LOAD} =10mA	ΔT _{SD}		15		°C
Discharge Resistance	V _{EN} =0V, V _{OUT} =0.1V			100		Ω

BLOCK DIAGRAM

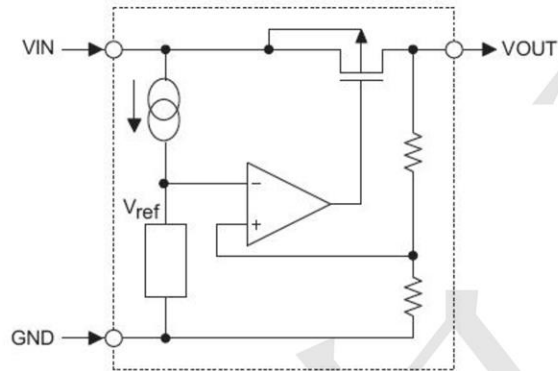

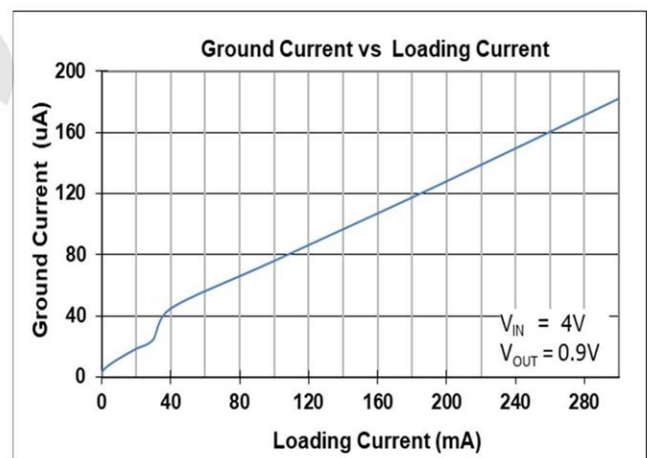
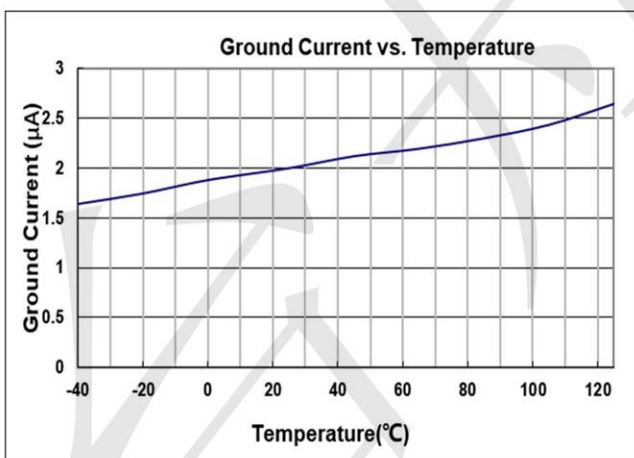
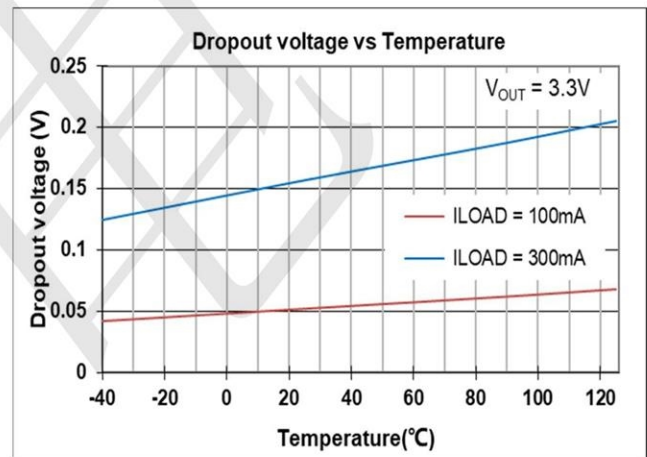
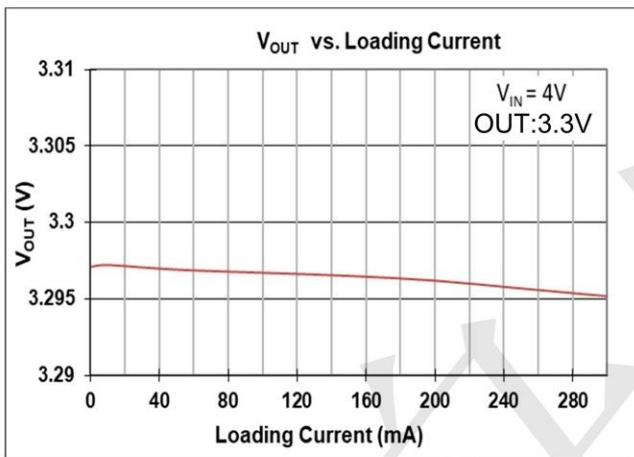
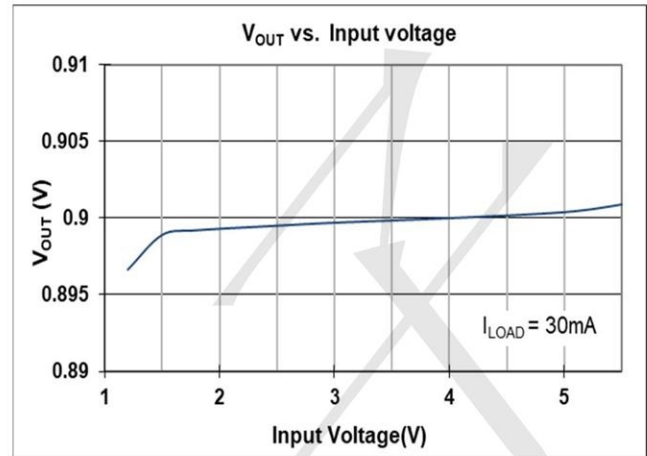
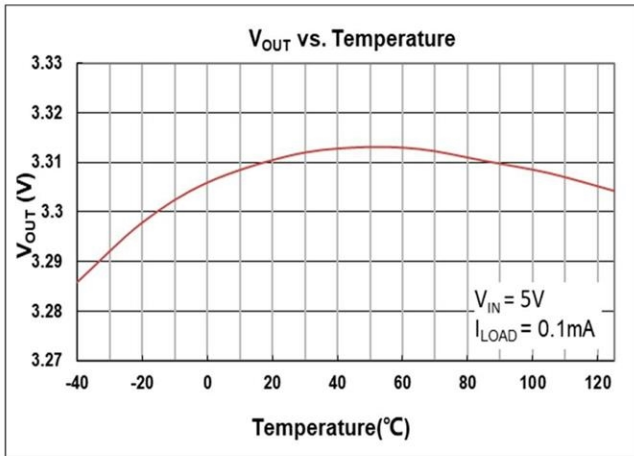

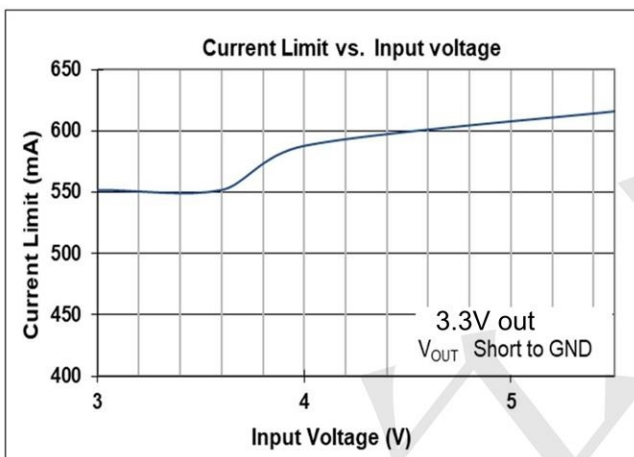
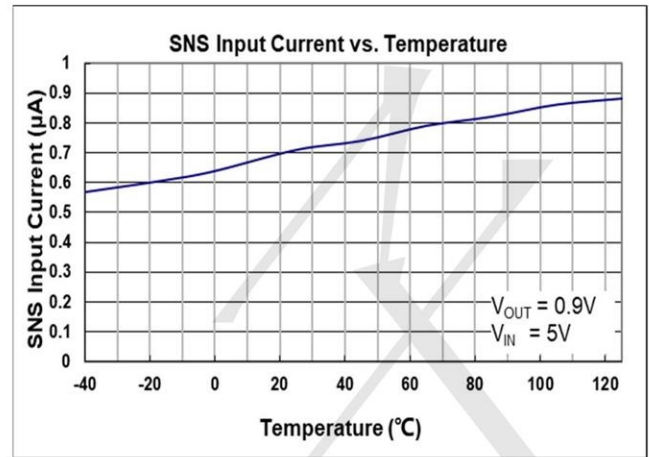
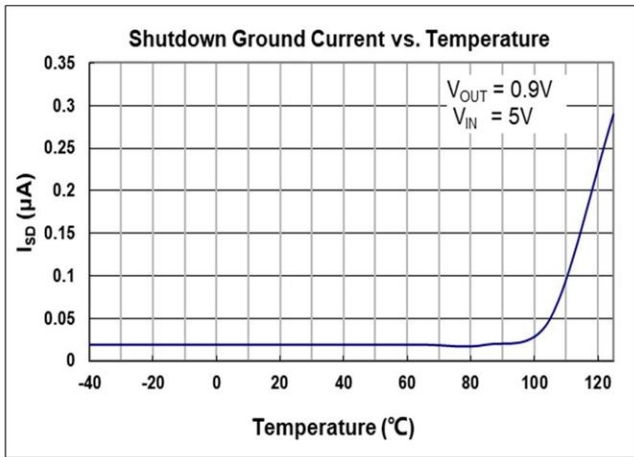

Current Limit Response

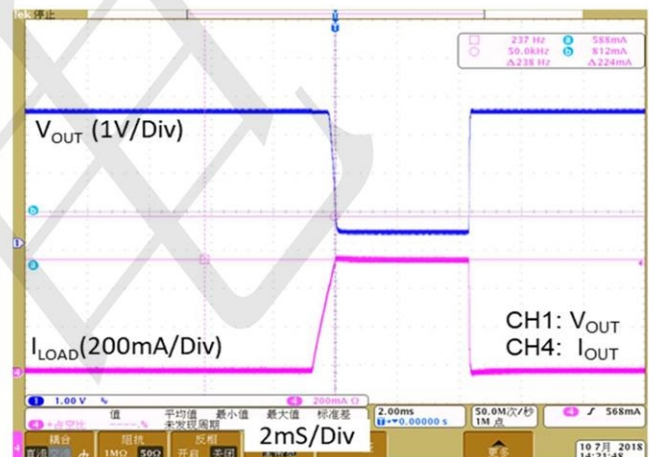

Load Transient Response I

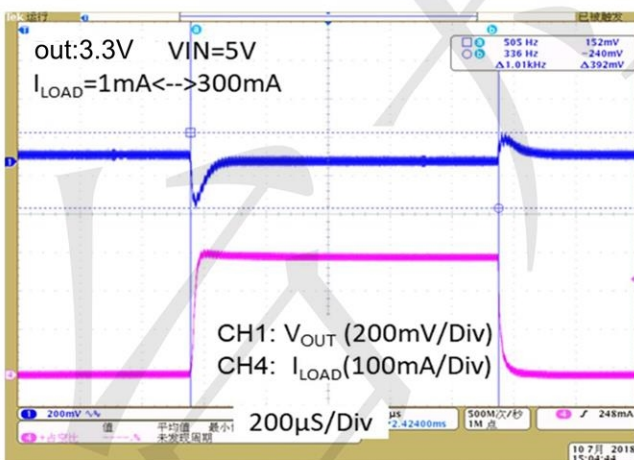

Load Transient Response II

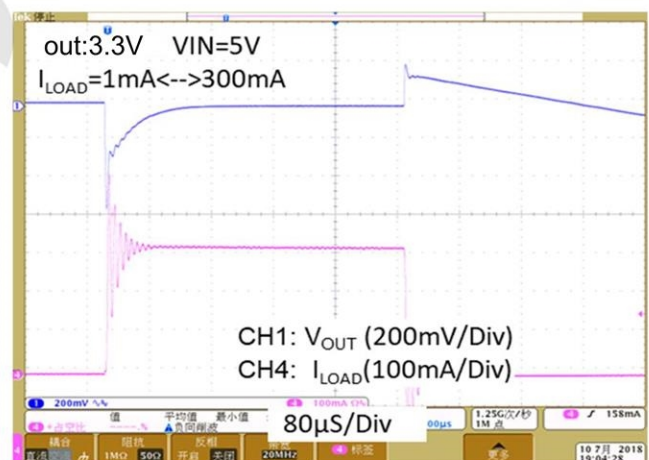

Line Transient Response

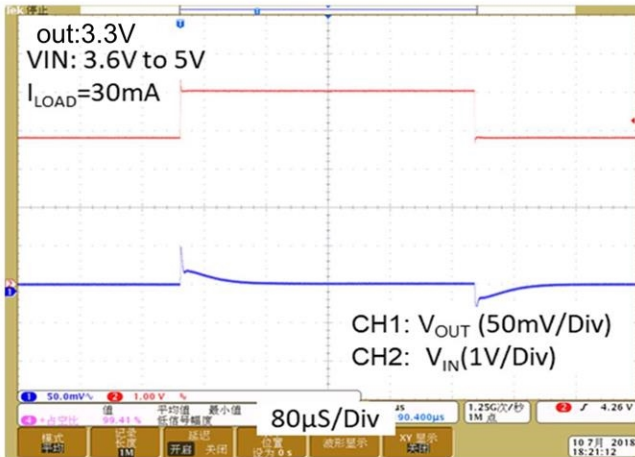

V_{OUT} Turn On/Off by EN

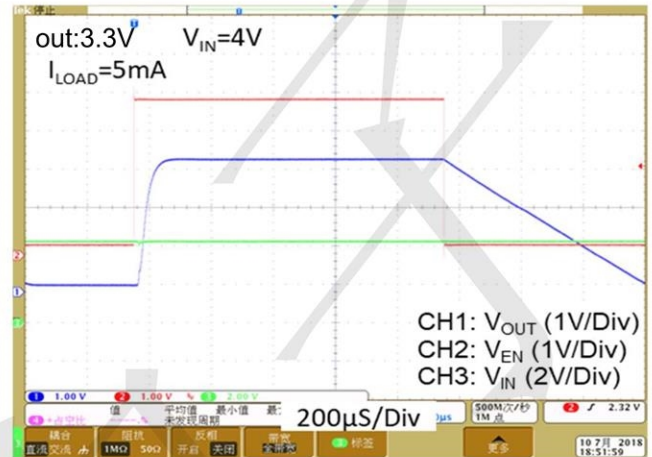



Package informantion

SOT89-3

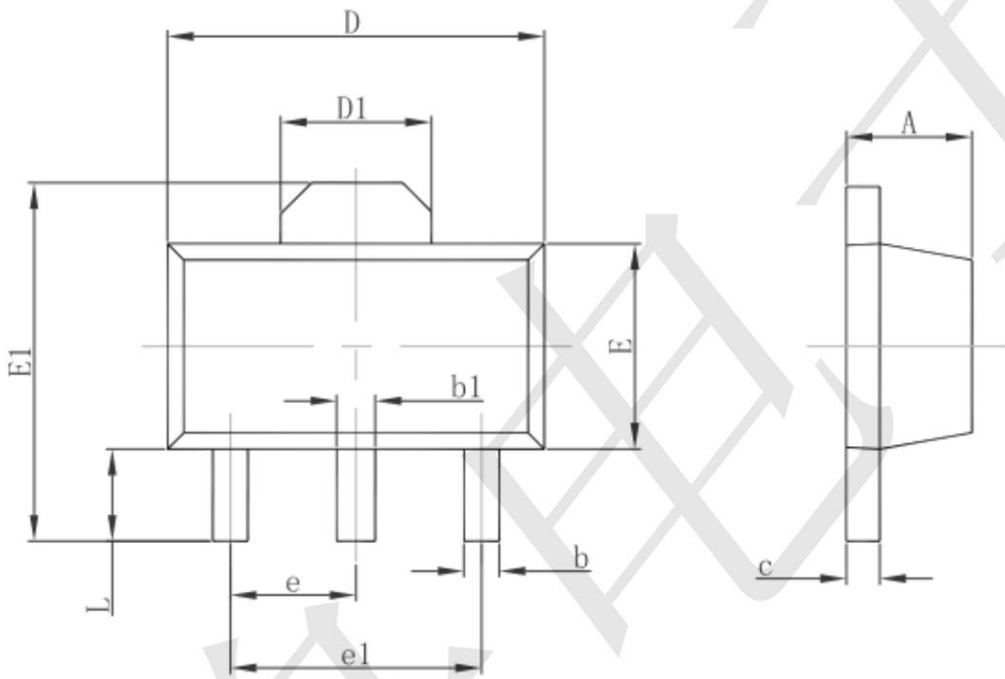

Symbol	Dimensions In Millimeters		Dimensions In Inches	
	Min.	Max.	Min.	Max.
A	1.400	1.600	0.055	0.063
b	0.320	0.520	0.013	0.020
b1	0.400	0.580	0.016	0.023
c	0.350	0.440	0.014	0.017
D	4.400	4.600	0.173	0.181
D1	1.550 REF.		0.061 REF.	
E	2.300	2.600	0.091	0.102
E1	3.940	4.250	0.155	0.167
e	1.500 TYP.		0.060 TYP.	
e1	3.000 TYP.		0.118 TYP.	
L	0.900	1.200	0.035	0.047



Package informantion

3-pin SOT23-5 Outline Dimensions

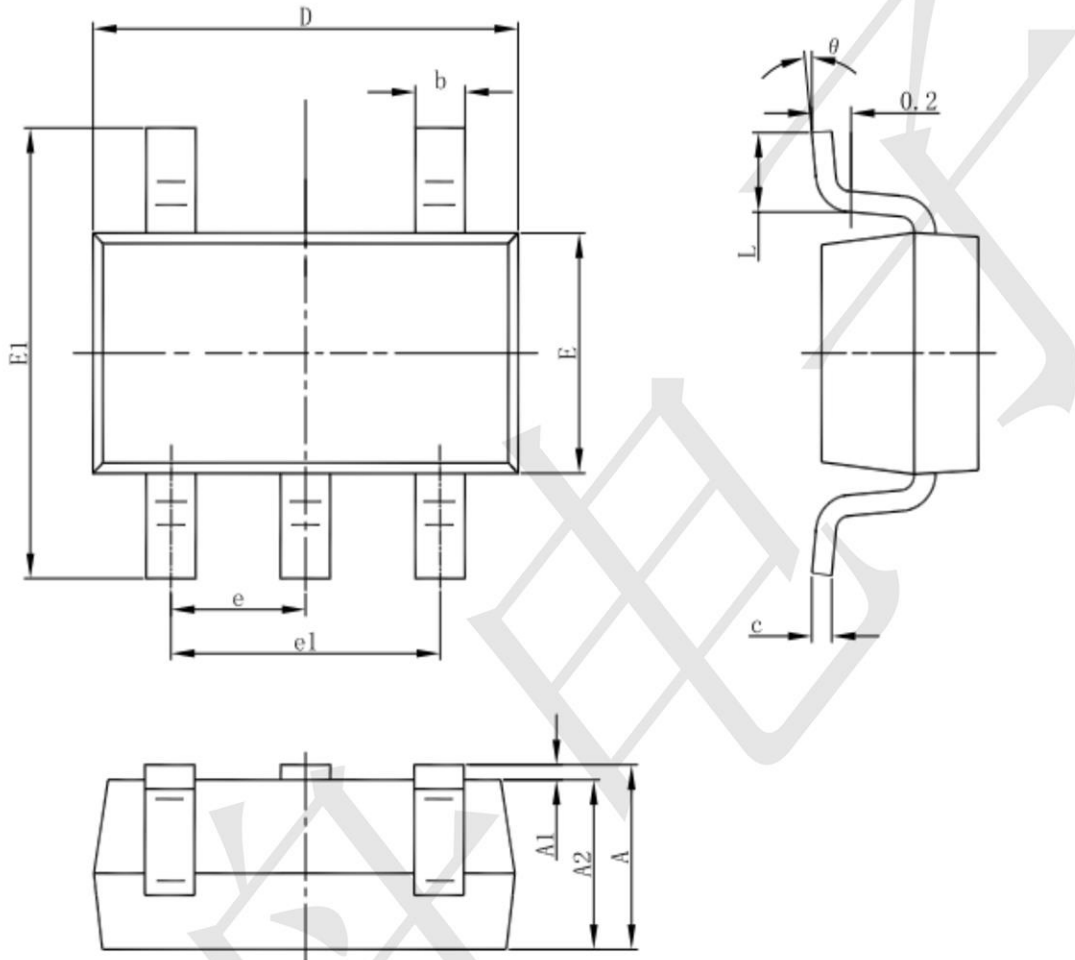

Symbol	Dimensions In Millimeters		Dimensions In Inches	
	Min	Max	Min	Max
A	1.050	1.250	0.041	0.049
A1	0.000	0.100	0.000	0.004
A2	1.050	1.150	0.041	0.045
b	0.300	0.500	0.012	0.020
c	0.100	0.200	0.004	0.008
D	2.820	3.020	0.111	0.119
E	1.500	1.700	0.059	0.067
E1	2.650	2.950	0.104	0.116
e	0.950(BSC)		0.037(BSC)	
e1	1.800	2.000	0.071	0.079
L	0.300	0.600	0.012	0.024
theta	0°	8°	0°	8°