

100V N-Channel Enhancement Mode MOSFET

Description

The AP8N10MI uses advanced trench technology to provide excellent $R_{DS(ON)}$, low gate charge and operation with gate voltages as low as 4.5V. This device is suitable for use as a Battery protection or in other Switching application.

General Features

$V_{DS} = 100V$ $I_D = 8A$

$R_{DS(ON)} < 100m\Omega @ V_{GS}=10V$ (Type: 80m Ω)

Application

Automotive lighting

Load switch

PSE

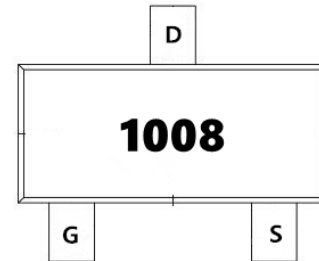
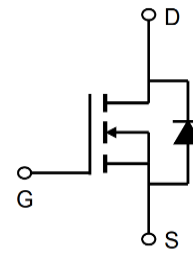

Top View

Bottom View

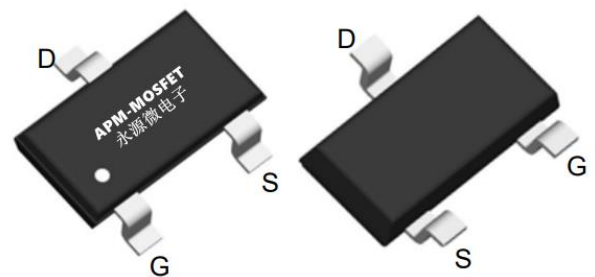

Package Marking and Ordering Information

Product ID	Pack	Marking	Qty(PCS)
AP8N10MI	SOT23-3L	1008	3000

Absolute Maximum Ratings (TC=25°C unless otherwise noted)

Symbol	Parameter	Rating	Units
V_{DS}	Drain-Source Voltage	100	V
V_{GS}	Gate-Source Voltage	± 20	V
$I_D @ T_C=25^\circ C$	Drain Current, $V_{GS} @ 10V$	8	A
$I_D @ T_C=100^\circ C$	Drain Current, $V_{GS} @ 10V$	6.5	A
IDM	Pulsed Drain Current ¹	24	A
$P_D @ T_C=25^\circ C$	Total Power Dissipation	30	W
$P_D @ T_A=25^\circ C$	Total Power Dissipation ³	2.7	W
TSTG	Storage Temperature Range	-55 to 150	°C
T_J	Operating Junction Temperature Range	-55 to 150	°C
$R_{\theta JA}$	Maximum Thermal Resistance, Junctionambient	100	°C/W
$R_{\theta JC}$	Maximum Thermal Resistance, Junction-case	5.1	°C/W

100V N-Channel Enhancement Mode MOSFET

Electrical Characteristics@T_j=25°C(unless otherwise specified)

Symbol	Parameter	Test Condition	Min.	Typ.	Max.	Units
V(BR)DSS	Drain-Source Breakdown Voltage	VGS=0V, ID=250μA	100	107	-	V
IDSS	Zero Gate Voltage Drain Current	VDS=100V, VGS=0V,	-	-	1.0	μA
IGSS	Gate to Body Leakage Current	VDS=0V, VGS=±20V	-	-	±100	nA
VGS(th)	Gate Threshold Voltage	VDS=VGS, ID=250μA	1.2	1.85	2.5	V
RDS(on)	Static Drain-Source on-Resistance note3	VGS=10V, ID=5A	-	80	100	mΩ
		VGS=4.5V, ID=3A	-	95	125	mΩ
g fs	Forward Transconductance	V DS =5V , I D =5A		14		S
RG	Gate Resistance	VDS = 0V, VGS = 0V,f =1MHz		3		Ω
Ciss	Input Capacitance	VDS=15V, VGS=0V, f=1.0MHz	-	1100	-	pF
Coss	Output Capacitance		-	55	-	pF
Crss	Reverse Transfer Capacitance		-	40	-	pF
Qg	Total Gate Charge	VDS=50V, ID=5A, VGS=10V	-	11.9	-	nC
Qgs	Gate-Source Charge		-	2.8	-	nC
Qgd	Gate-Drain("Miller") Charge		-	1.7	-	nC
td(on)	Turn-on Delay Time	VDS=30V, ID=5A, RG=1.8Ω, VGS=10V	-	3.8	-	ns
tr	Turn-on Rise Time		-	25.8	-	ns
td(off)	Turn-off Delay Time		-	16	-	ns
tf	Turn-off Fall Time		-	8.8	-	ns
IS	Continuous Source Current1,5	VG=VD=0V , Force Current	-	-	14.6	A
ISM	Pulsed Source Current2,5		-	-	25	A
VSD	Diode Forward Voltage2	VGS=0V, IS=10A	-	-	1.2	V

Note :

- 1、 The data tested by surface mounted on a 1 inch 2 FR-4 board with 2OZ copper.
- 2、 The data tested by pulsed , pulse width $\leq 300\mu s$, duty cycle $\leq 2\%$
- 3、 The power dissipation is limited by 150°C junction temperature
- 4、 The data is theoretically the same as I D and I DM , in real applications , should be limited by total power dissipation.

100V N-Channel Enhancement Mode MOSFET

Typical Characteristics

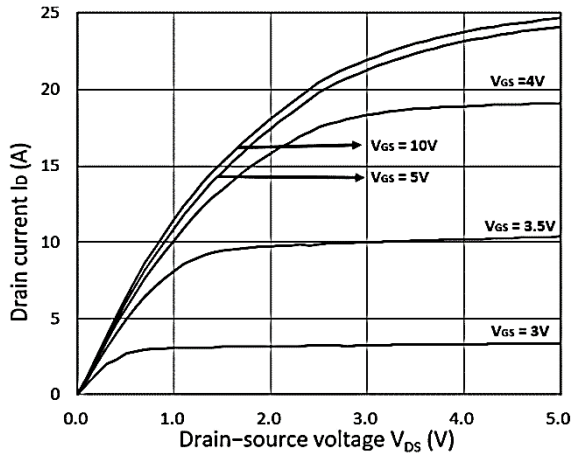

Figure 1. Output Characteristics

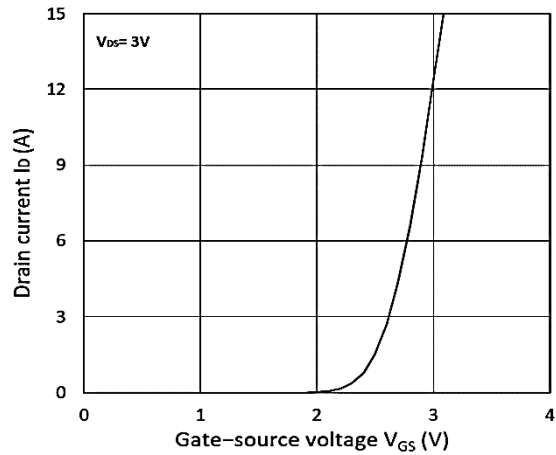

Figure 2. Transfer Characteristics

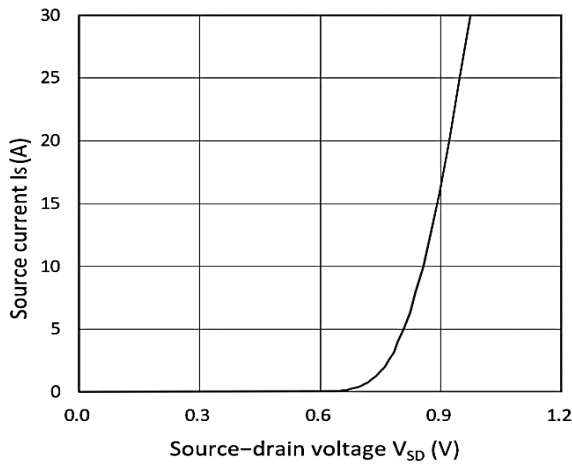

Figure 3. Forward Characteristics of Reverse

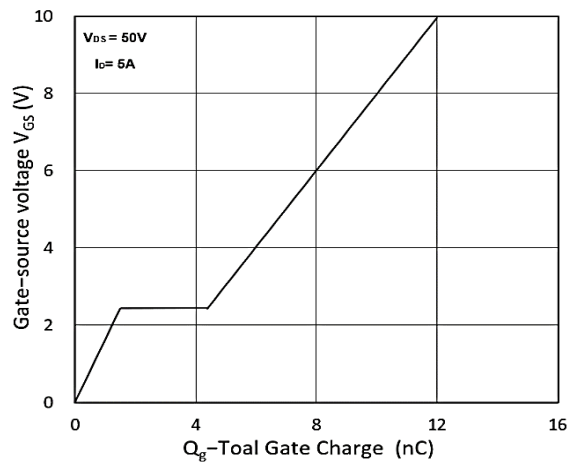

Figure 4. Gate Charge Characteristics

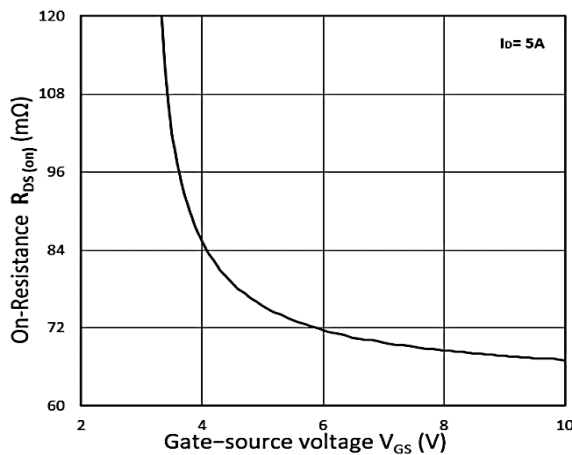

Figure 5. $R_{DS(on)}$ vs. V_{GS}

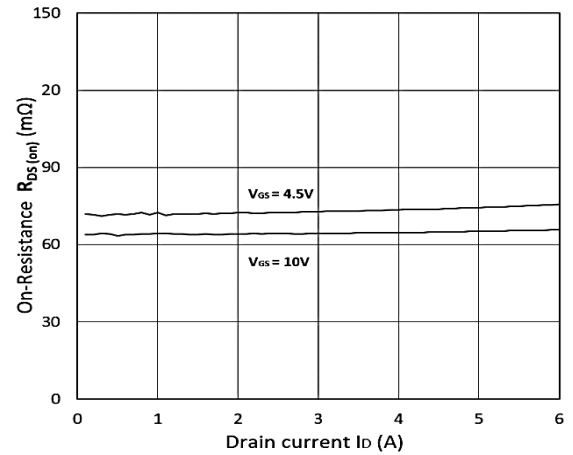

Figure 6. $R_{DS(on)}$ vs. I_D

100V N-Channel Enhancement Mode MOSFET

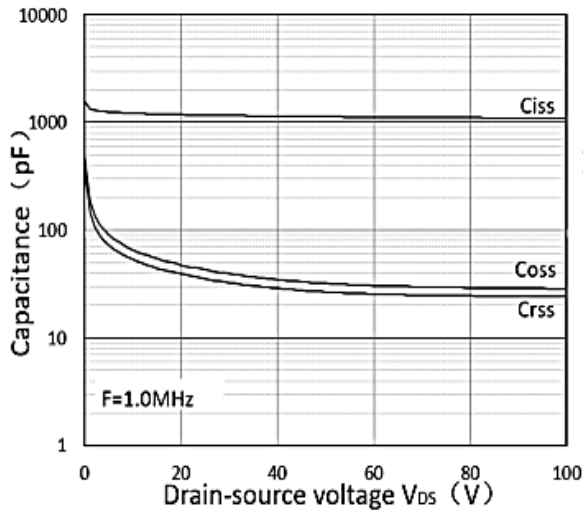

Figure 7. Capacitance Characteristics

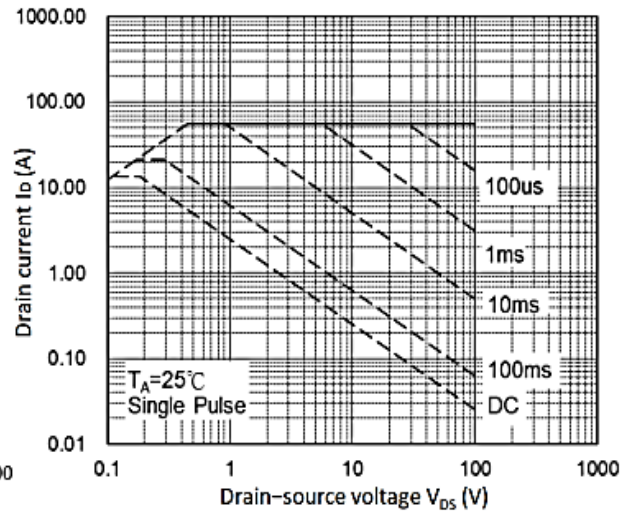

Figure 8. Safe Operating Area

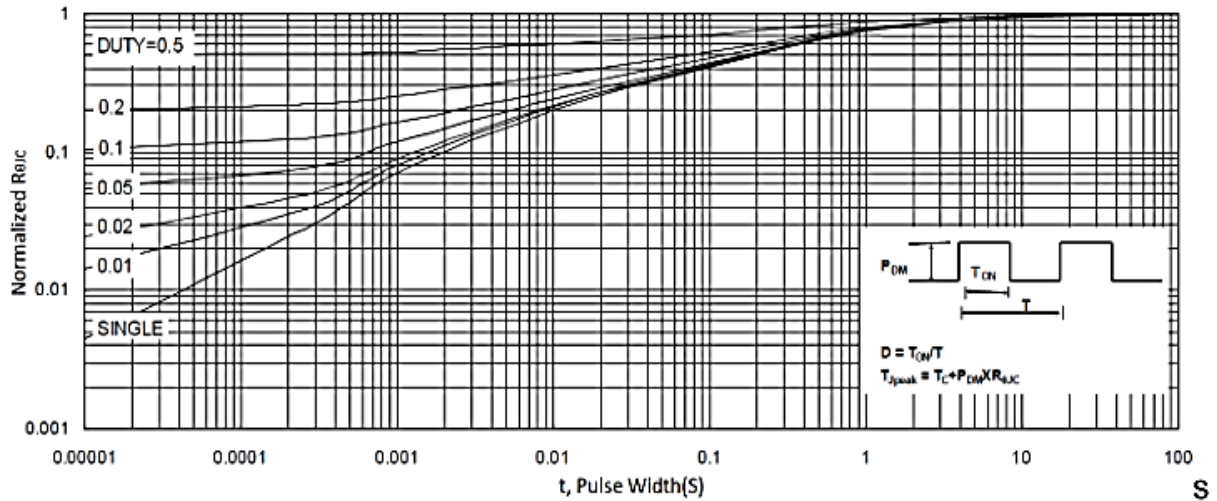

Figure 9. Normalized Maximum Transient Thermal Impedance

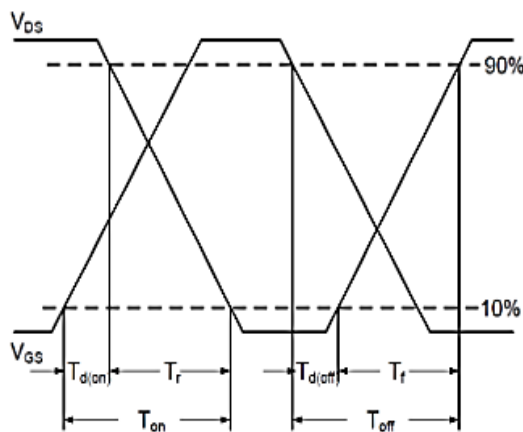

Figure 10. Switching Time Waveform

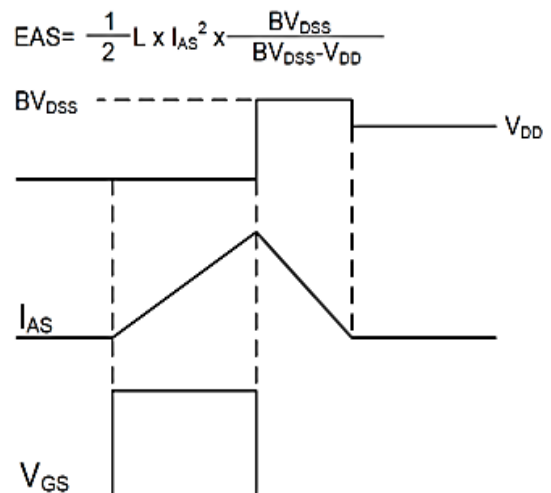
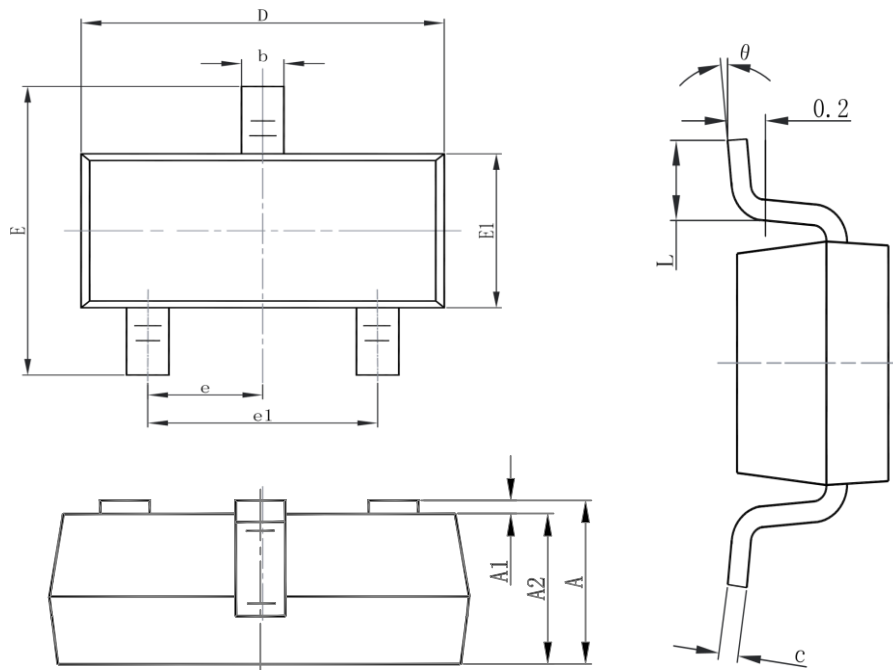

Figure 11. Unclamped Inductive Switching Waveform



100V N-Channel Enhancement Mode MOSFET

Package Mechanical Data-SOT23-3-SLS-Single



Symbol	Dimensions In Millimeters		Dimensions In Inches	
	Min.	Max.	Min.	Max.
A	1.050	1.250	0.041	0.049
A1	0.000	0.100	0.000	0.004
A2	1.050	1.150	0.041	0.045
b	0.300	0.500	0.012	0.020
c	0.100	0.200	0.004	0.008
D	2.820	3.020	0.111	0.119
E1	1.500	1.700	0.059	0.067
E	2.650	2.950	0.104	0.116
e	0.950(BSC)		0.037(BSC)	
e1	1.800	2.000	0.071	0.079
L	0.300	0.600	0.012	0.024
θ	0°	8°	0°	8°

100V N-Channel Enhancement Mode MOSFET

Attention

1, Any and all APM Microelectronics products described or contained herein do not have specifications that can handle applications that require extremely high levels of reliability, such as life support systems, aircraft's control systems, or other applications whose failure can be reasonably expected to result in serious physical and/or material damage. Consult with your APM Microelectronics representative nearest you before using any APM Microelectronics products described or contained herein in such applications.

2, APM Microelectronics assumes no responsibility for equipment failures that result from using products at values that exceed, even momentarily, rated values (such as maximum ratings, operating condition ranges, or other parameters) listed in products specifications of any and all APM Microelectronics products described or contained herein.

3, Specifications of any and all APM Microelectronics products described or contained here stipulate the performance, characteristics, and functions of the described products in the independent state, and are not guarantees of the performance, characteristics, and functions of the described products as mounted in the customer's products or equipment. To verify symptoms and states that cannot be evaluated in an independent device, the customer should always evaluate and test devices mounted in the customer's products or equipment.

4, APM Microelectronics Semiconductor CO., LTD. strives to supply high quality high reliability products. However, any and all semiconductor products fail with some probability. It is possible that these probabilistic failures could give rise to accidents or events that could endanger human lives that could give rise to smoke or fire, or that could cause damage to other property. When designing equipment, adopt safety measures so that these kinds of accidents or events cannot occur. Such measures include but are not limited to protective circuits and error prevention circuits for safe design, redundant design, and structural design.

5, In the event that any or all APM Microelectronics products (including technical data, services) described or contained herein are controlled under any of applicable local export control laws and regulations, such products must not be exported without obtaining the export license from the authorities concerned in accordance with the above law.

6, No part of this publication may be reproduced or transmitted in any form or by any means, electronic or mechanical, including photocopying and recording, or any information storage or retrieval system, or otherwise, without the prior written permission of APM Microelectronics Semiconductor CO., LTD.

7, Information (including circuit diagrams and circuit parameters) herein is for example only; it is not guaranteed for volume production. APM Microelectronics believes information herein is accurate and reliable, but no guarantees are made or implied regarding its use or any infringements of intellectual property rights or other rights of third parties.

8, Any and all information described or contained herein are subject to change without notice due to product/technology improvement, etc. When designing equipment, refer to the "Delivery Specification" for the APM Microelectronics product that you intend to use.

100V N-Channel Enhancement Mode MOSFET

Edition	Date	Change
Rve1.0	2020/1/31	Initial release

Copyright Attribution“APM-Microelectronice”

