

1. GENERAL:
  - a. APPLICATION SPECIFICATION SEE: AS-34791-020
  - b. PRODUCT SPECIFICATION SEE: PS-34791-020
  - c. PACKAGING SPECIFICATION PER MOLEX DRAWING: SEE CHART
  - d. PARTS MUST BE IN COMPLIANCE TO MOLEX CHEMICAL SUBSTANCES FOR PRODUCTS AND PACKAGING SPECIFICATION: QEH5-699000-301
  - e. DATA MUST BE SUBMITTED UNDER THE MOLEX PART NUMBER TO IMDS (COMPANY ID#13255)
  - f. FLAMMABILITY REQUIREMENT: PER ISO3795 OR GM3191
    1. BURN RATE 100 mm/MIN MAXIMUM
    2. MATERIAL MUST BE SELF EXTINGUISHING
  - g. VISUAL DEFECTS SHALL MEET COSMETIC STANDARD PS-45499-002 (Class B)
  - h. FOR TERMINAL USAGE, REFER TO MOLEX SALES DRAWING SD-560023-002
2. DESIGN - MATERIALS: SEE PIN TABLE
3. DESIGN - GEOMETRY:
  - a. THIS IS A 100% CAD GENERATED PART. THE CAD MATHEMATICAL DATA IS THE MASTER FOR THIS PART. FOR DIMENSIONAL OR ANY INFORMATION NOT SHOWN ON THIS DRAWING, ANALYZE THE CAD MODEL.
  - b. GEOMETRIC DIMENSIONS AND TOLERANCES PER ASME Y14.5M - 2009
  - c. GENERAL TOLERANCES:
    - LINEAR: PER DIN 16901 CODE B FOR PRECISION ENGINEERING (SEE TABLE)
    - ANGULAR: ±3°
  - d. EDGES AND UNDIMENSIONED DETAILS PER ISO13715
  - e. CORNERS SHOWN AS SHARP TO BE R 0.2 MAX
  - f. LETTERING SHALL BE 0.15 MAX RAISED IN 0.15 MAX RECESS PAD AND NOT PROTRUDE THE SURFACE. THIS INCLUDES RECYCLING CODE, PLANT AND CAVITY ID, VENDOR ID, CIRCUIT ID, AND PART SERIES NUMBER.
  - g. DIMENSION APPLIES ONLY TO RECEPTACLES WITH LOCK BRIDGE OPTION.

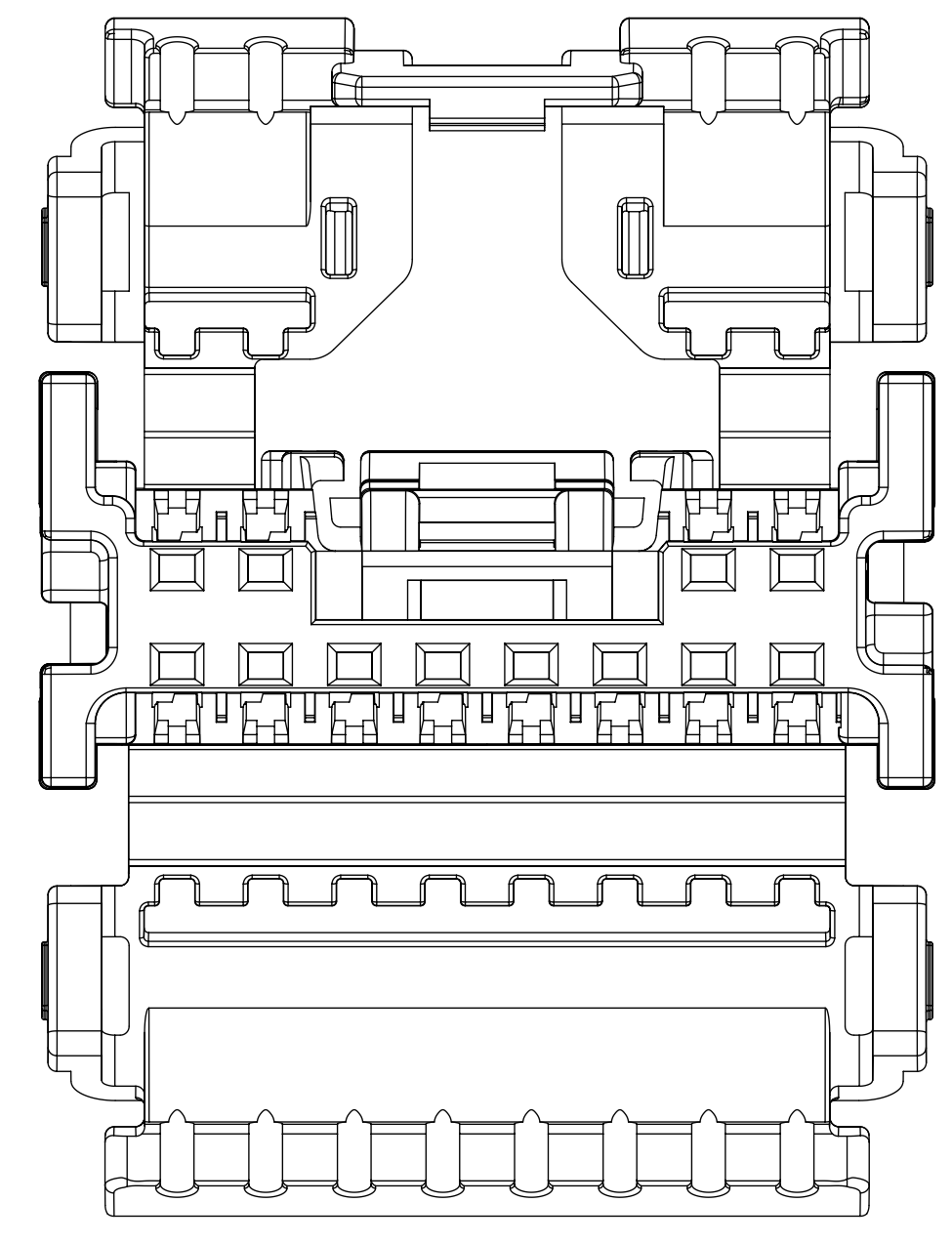

12 CIRCUIT RECEPTACLE WITHOUT LOCK BRIDGE  
POLARIZATION OPTION A  
USCAR COMPATIBLE

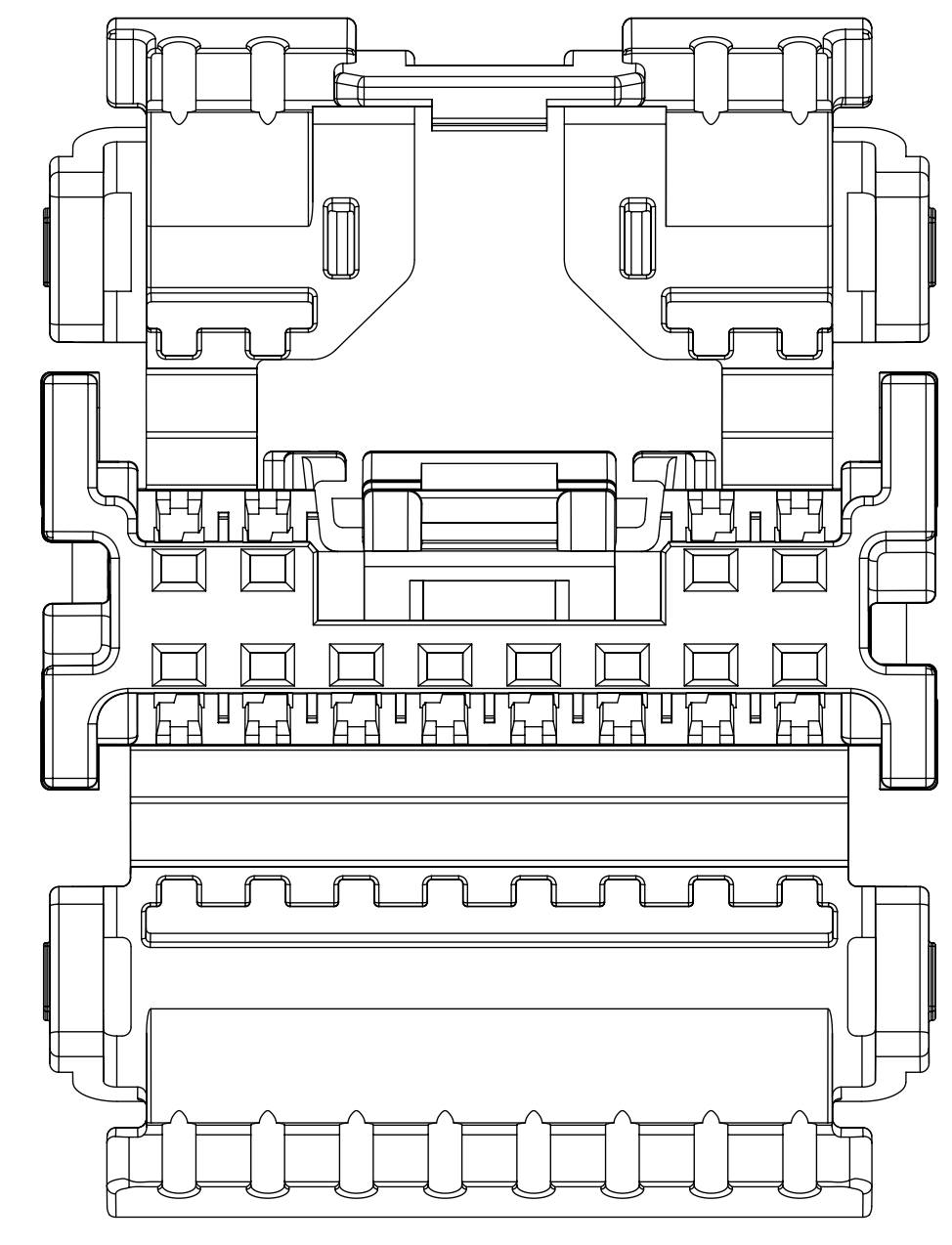

12 CIRCUIT RECEPTACLE WITHOUT LOCK BRIDGE  
POLARIZATION OPTION B  
USCAR COMPATIBLE

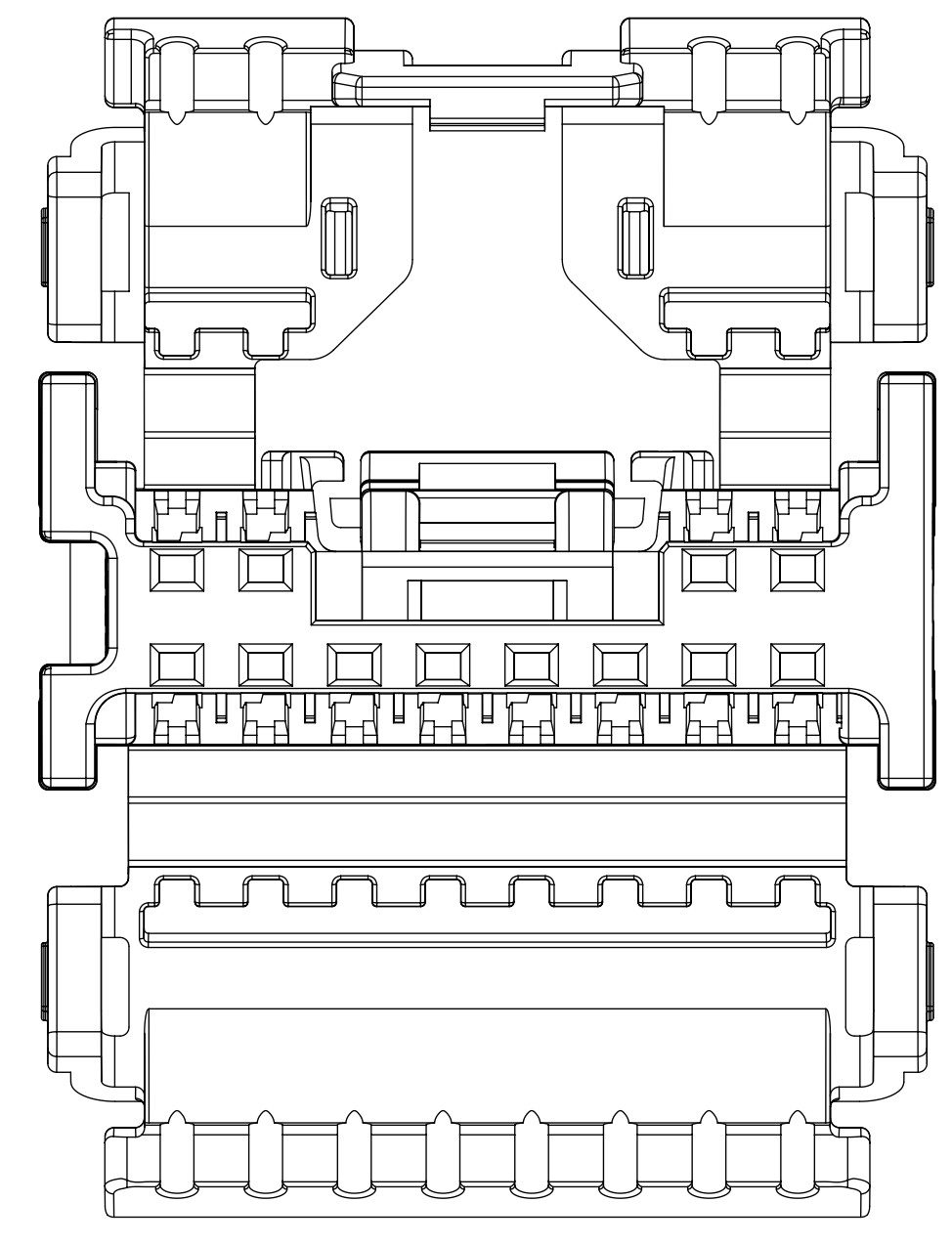

12 CIRCUIT RECEPTACLE WITHOUT LOCK BRIDGE  
POLARIZATION OPTION C  
USCAR COMPATIBLE

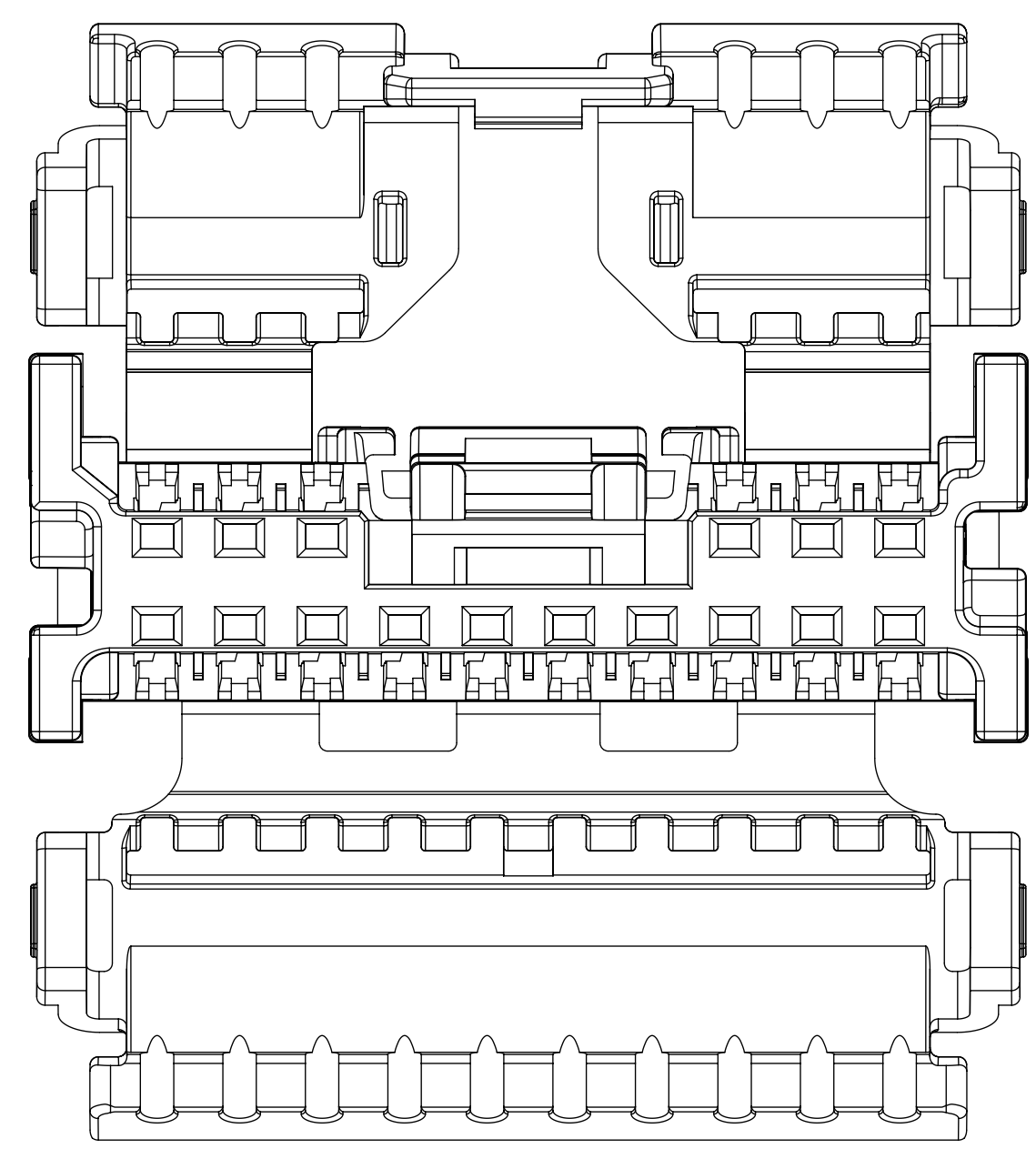

16 CIRCUIT RECEPTACLE WITHOUT LOCK BRIDGE  
POLARIZATION OPTION A

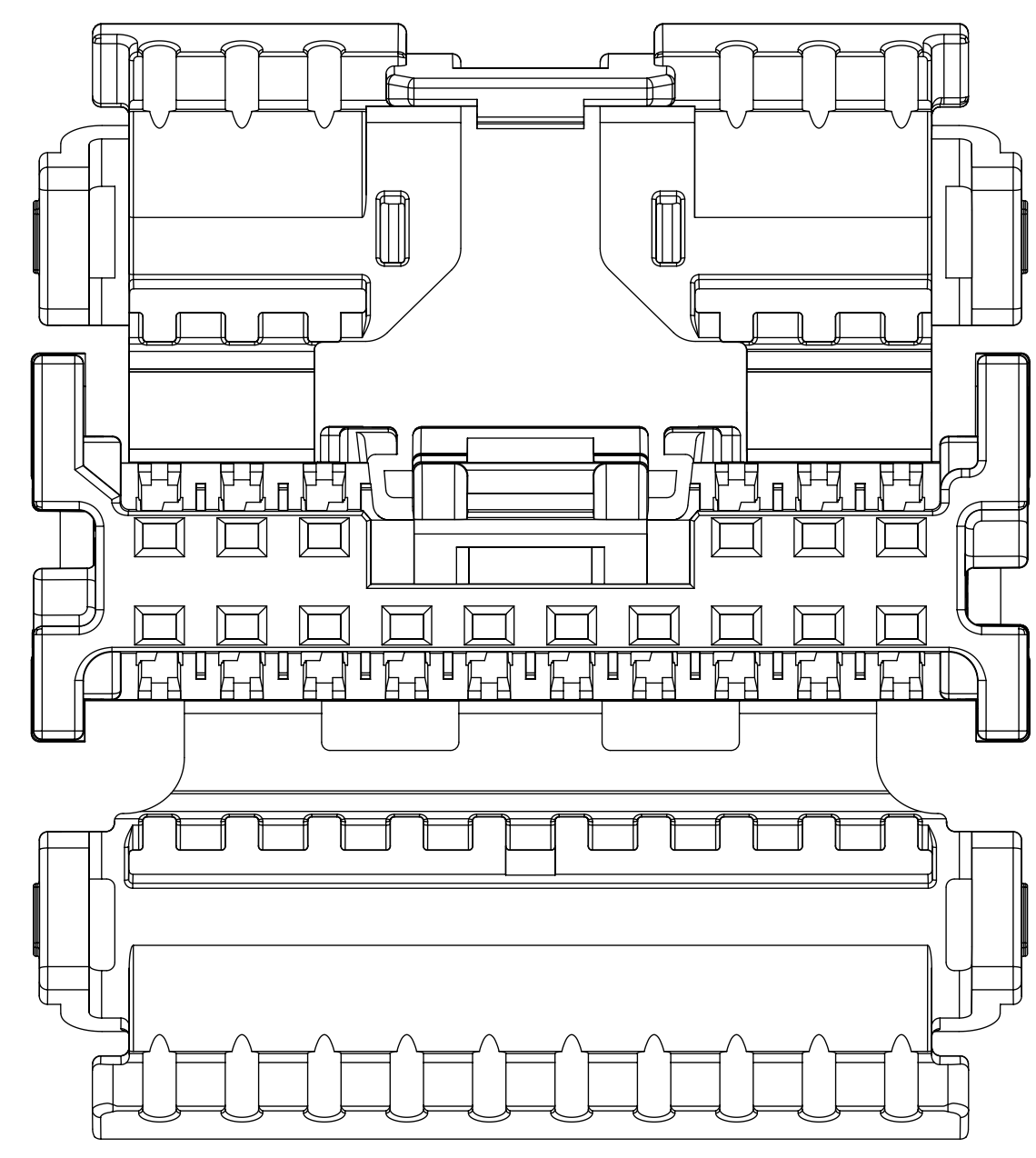

16 CIRCUIT RECEPTACLE WITHOUT LOCK BRIDGE  
POLARIZATION OPTION B

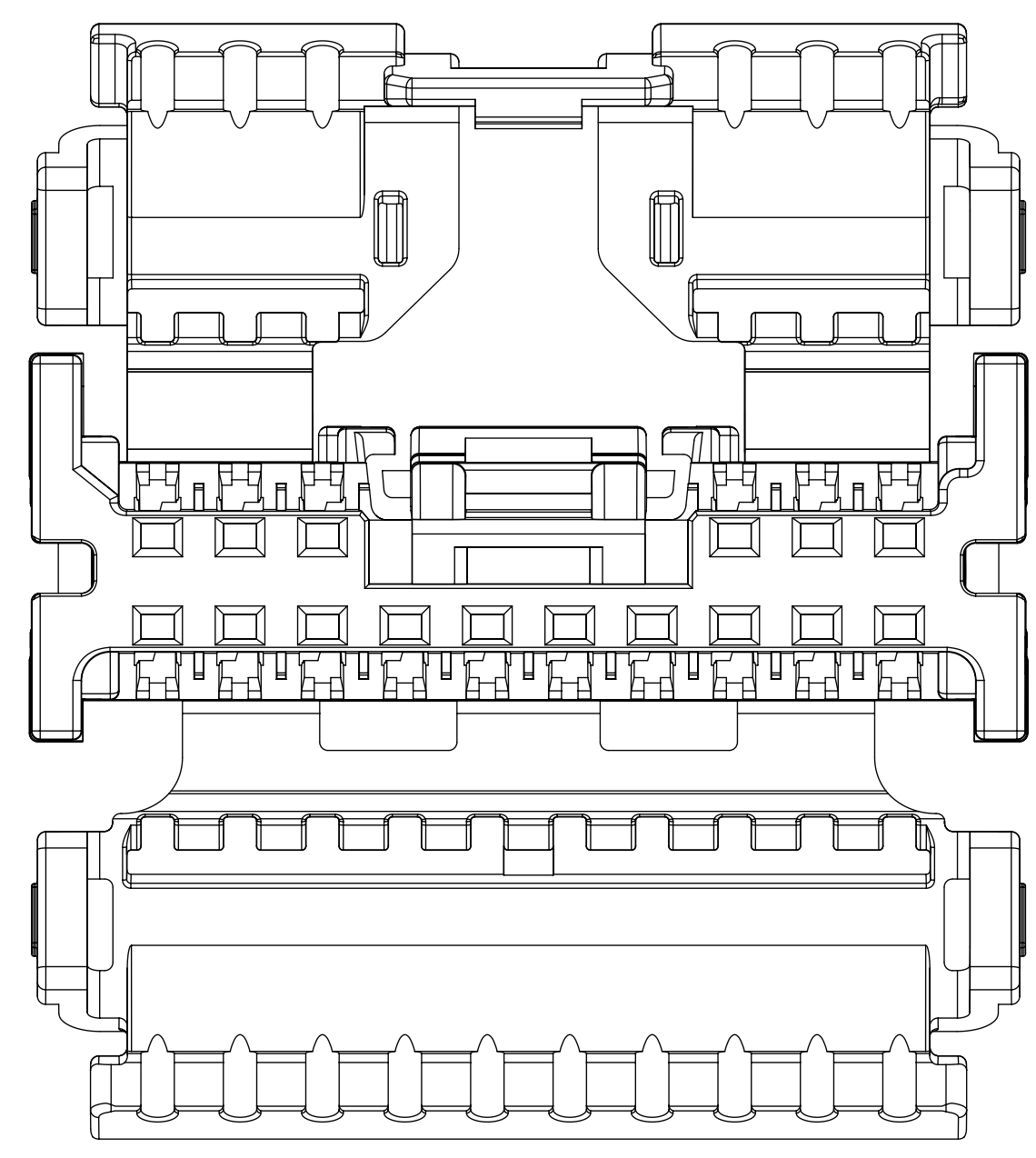

16 CIRCUIT RECEPTACLE WITHOUT LOCK BRIDGE  
POLARIZATION OPTION C

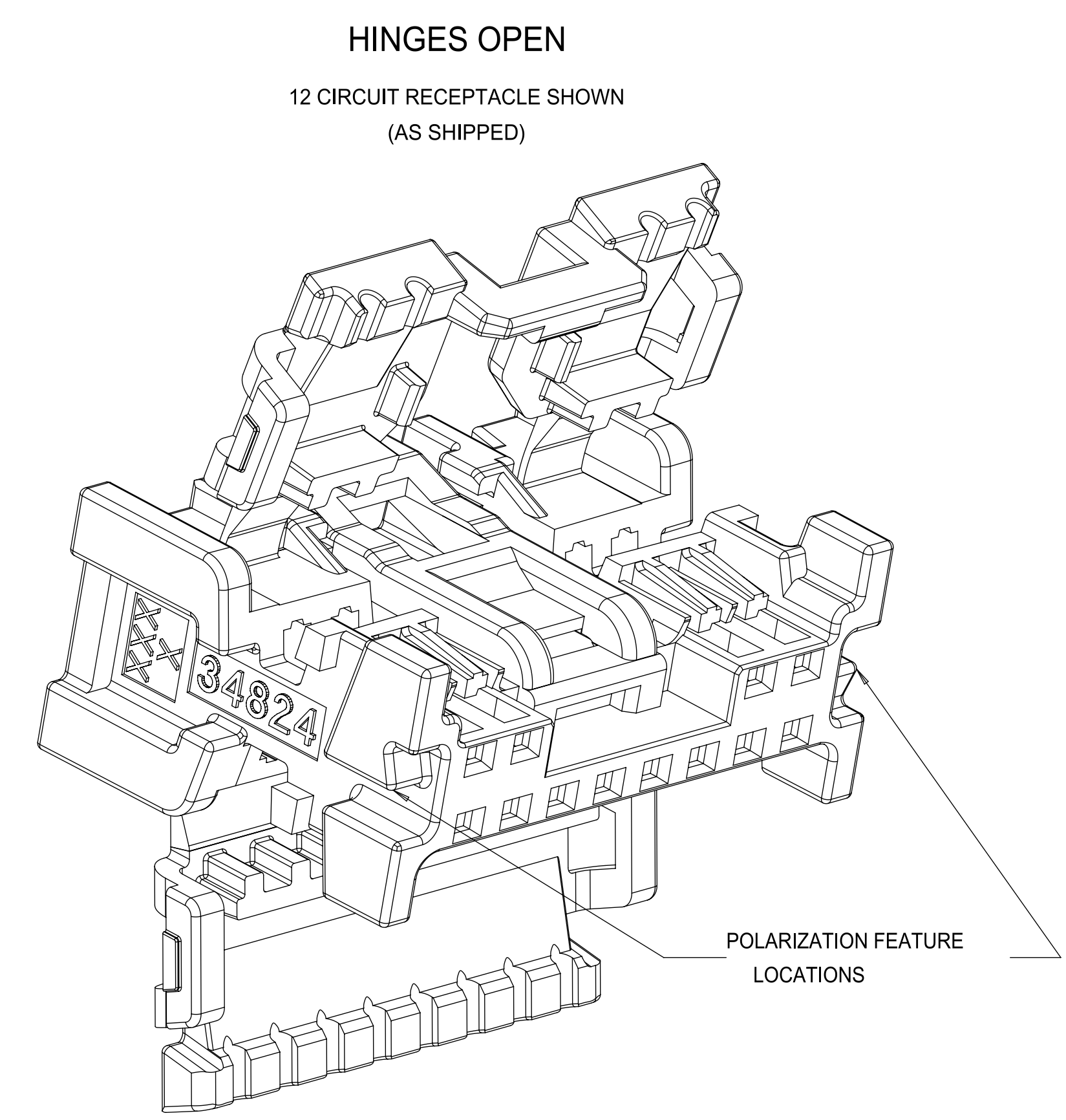

HINGES OPEN  
12 CIRCUIT RECEPTACLE SHOWN  
(AS SHIPPED)

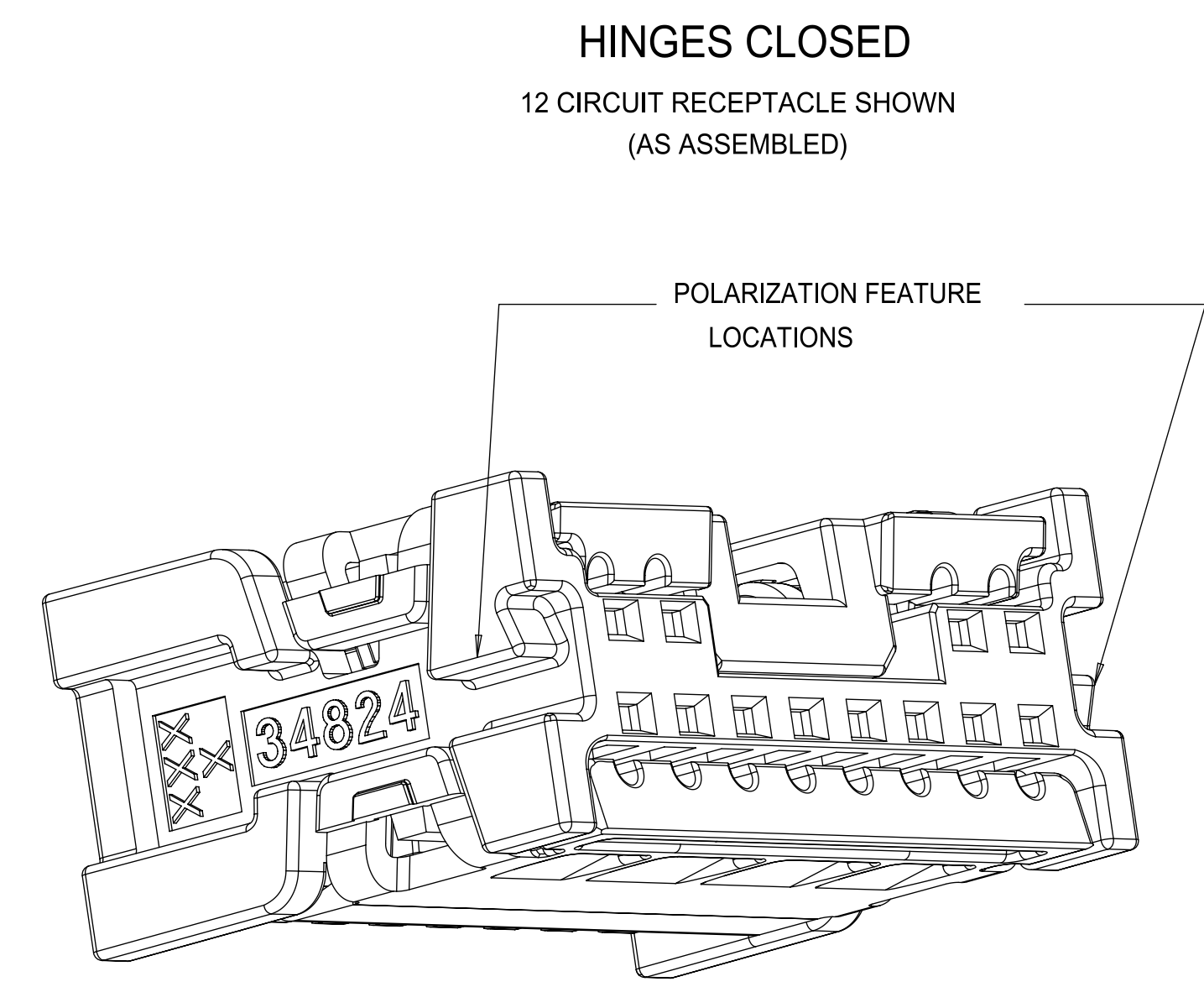

HINGES CLOSED  
12 CIRCUIT RECEPTACLE SHOWN  
(AS ASSEMBLED)

SCALE 7:1

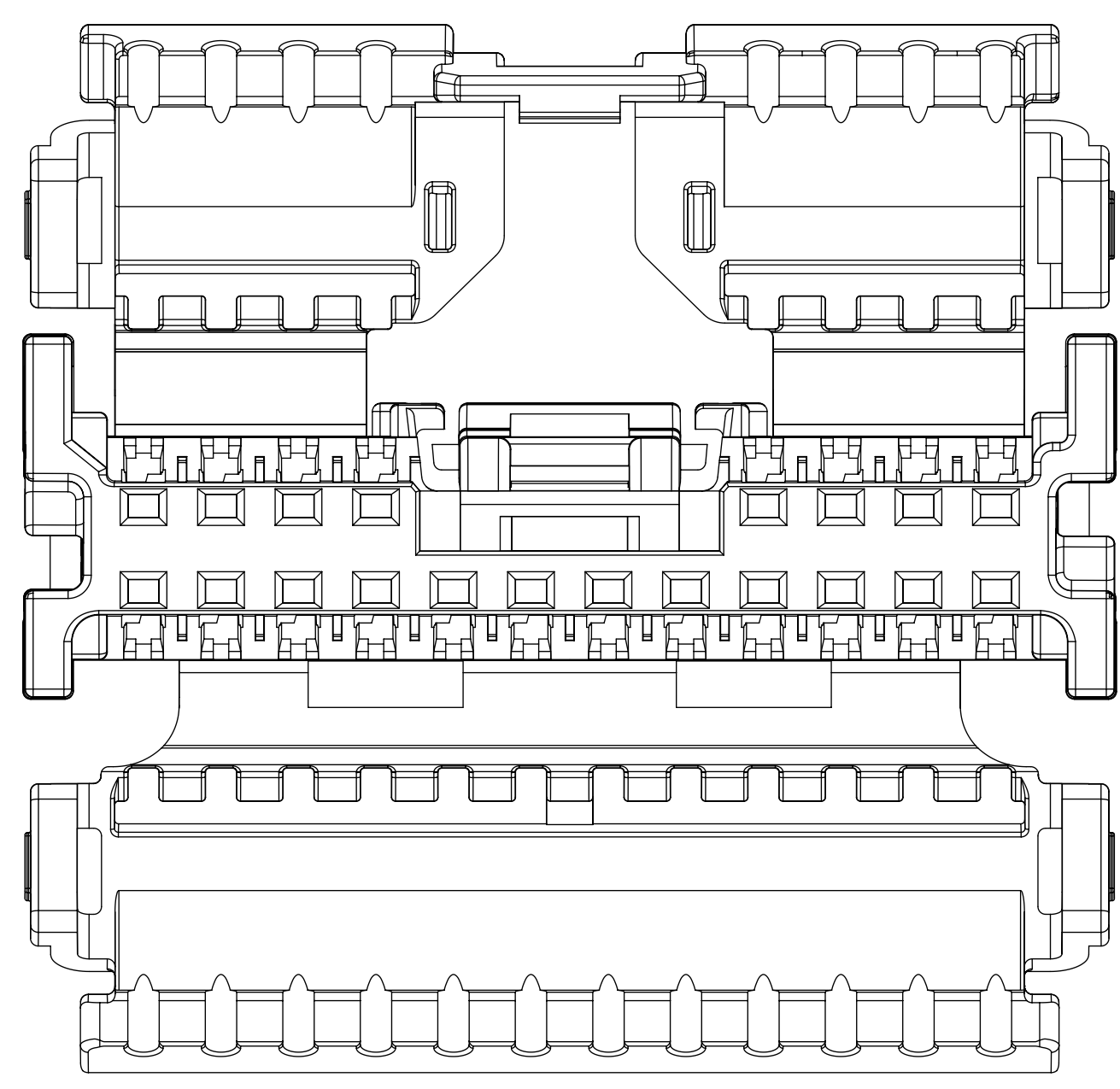

20 CIRCUIT RECEPTACLE WITHOUT LOCK BRIDGE  
POLARIZATION OPTION A

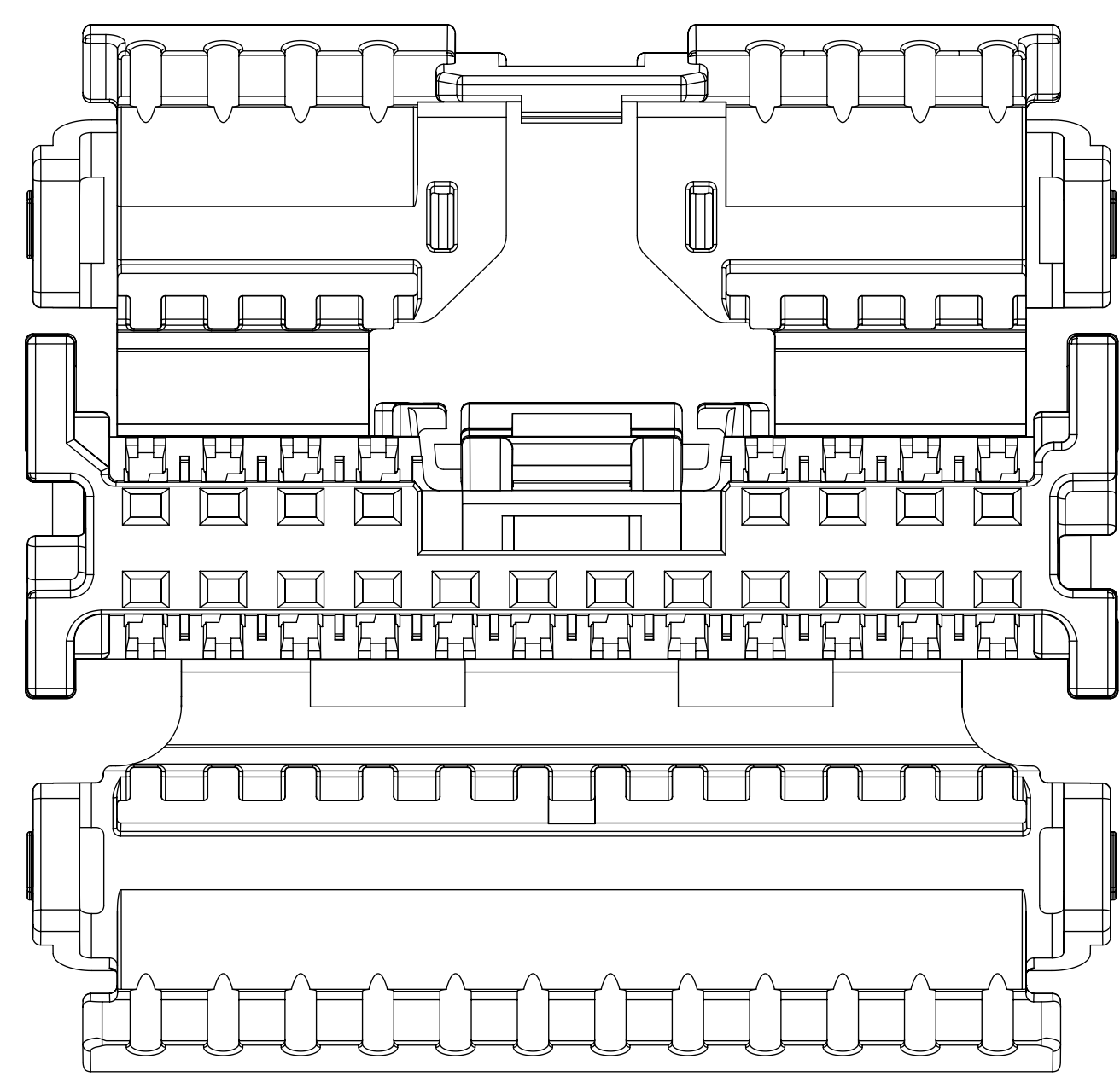

20 CIRCUIT RECEPTACLE WITHOUT LOCK BRIDGE  
POLARIZATION OPTION B

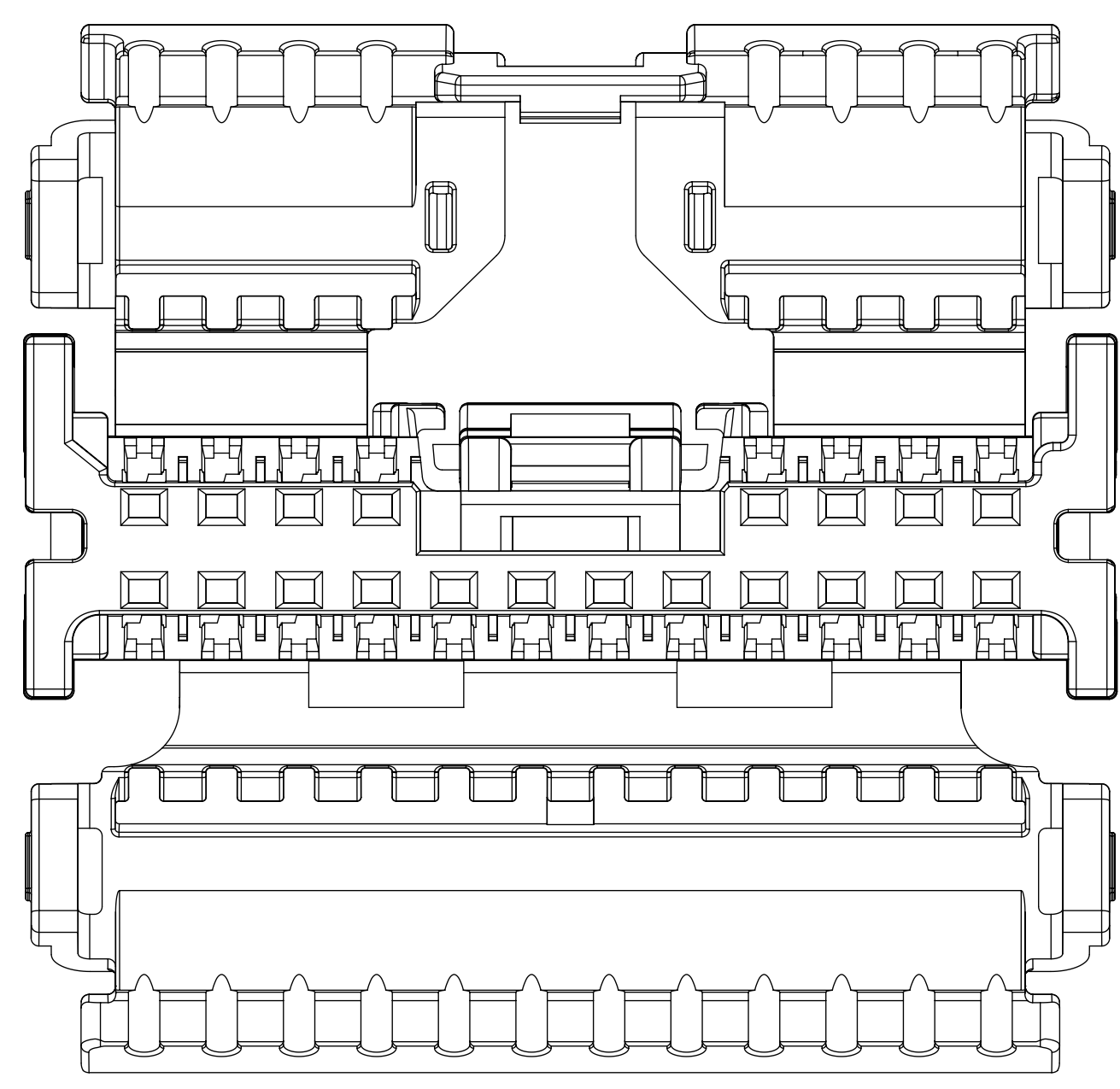

20 CIRCUIT RECEPTACLE WITHOUT LOCK BRIDGE  
POLARIZATION OPTION C

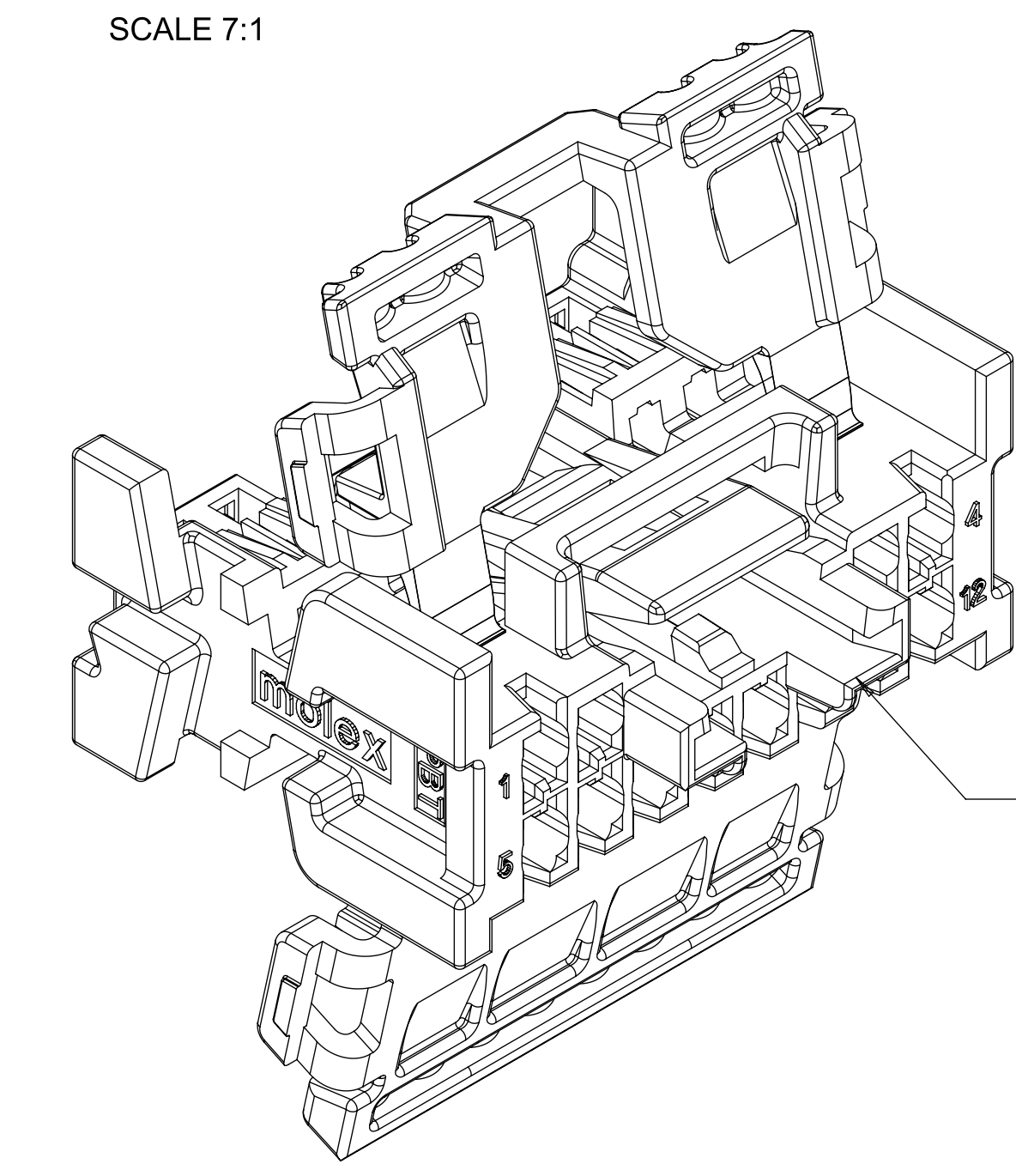

SCALE 7:1

MINI50 WITH BRIDGE OPTION  
COMES WITH CPA TRAY  
\*REFER TO SD-34824-003 FOR  
CPA-RECEPTACLE ASSEMBLIES

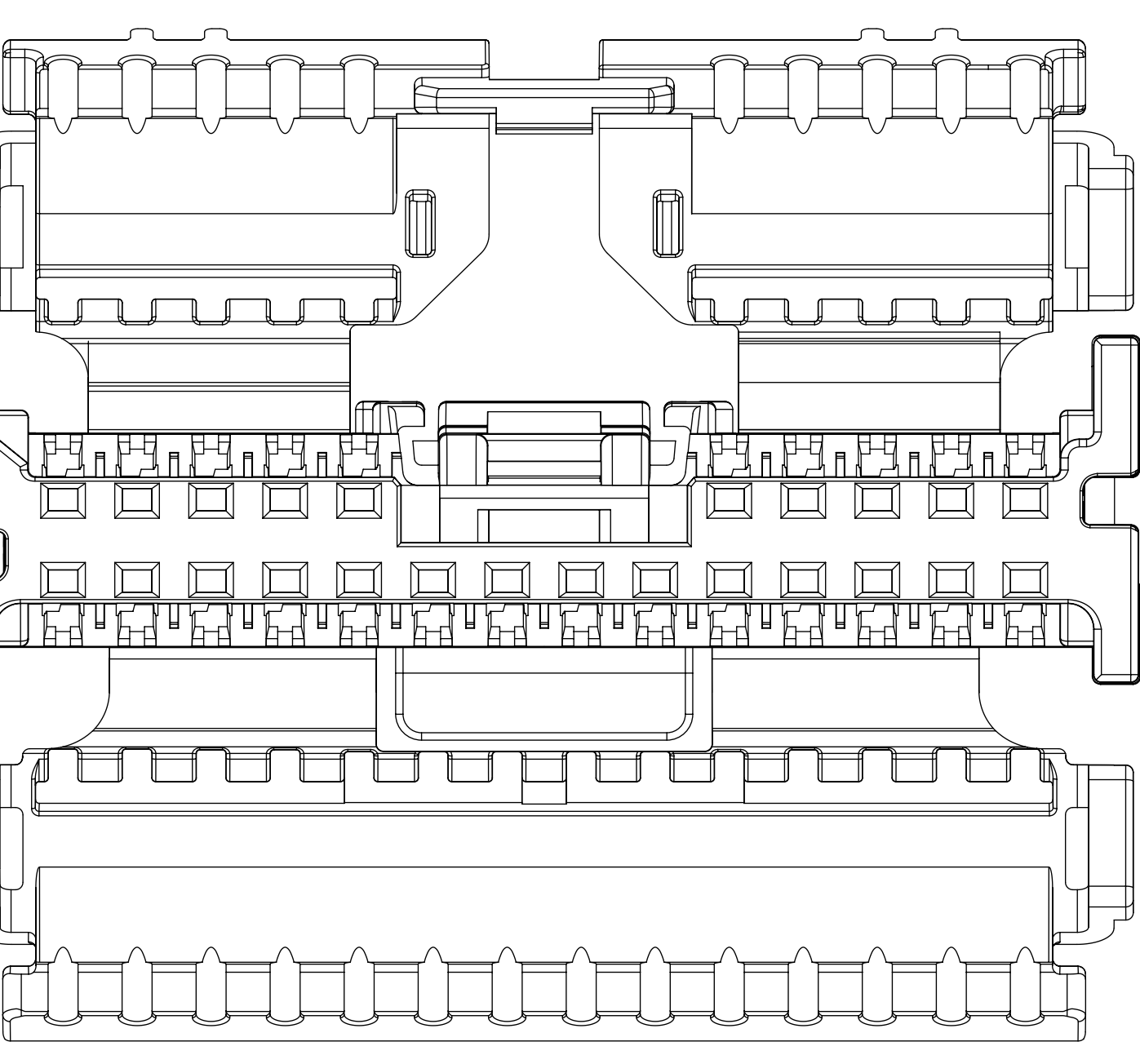

24 CIRCUIT RECEPTACLE WITHOUT LOCK BRIDGE  
POLARIZATION OPTION A

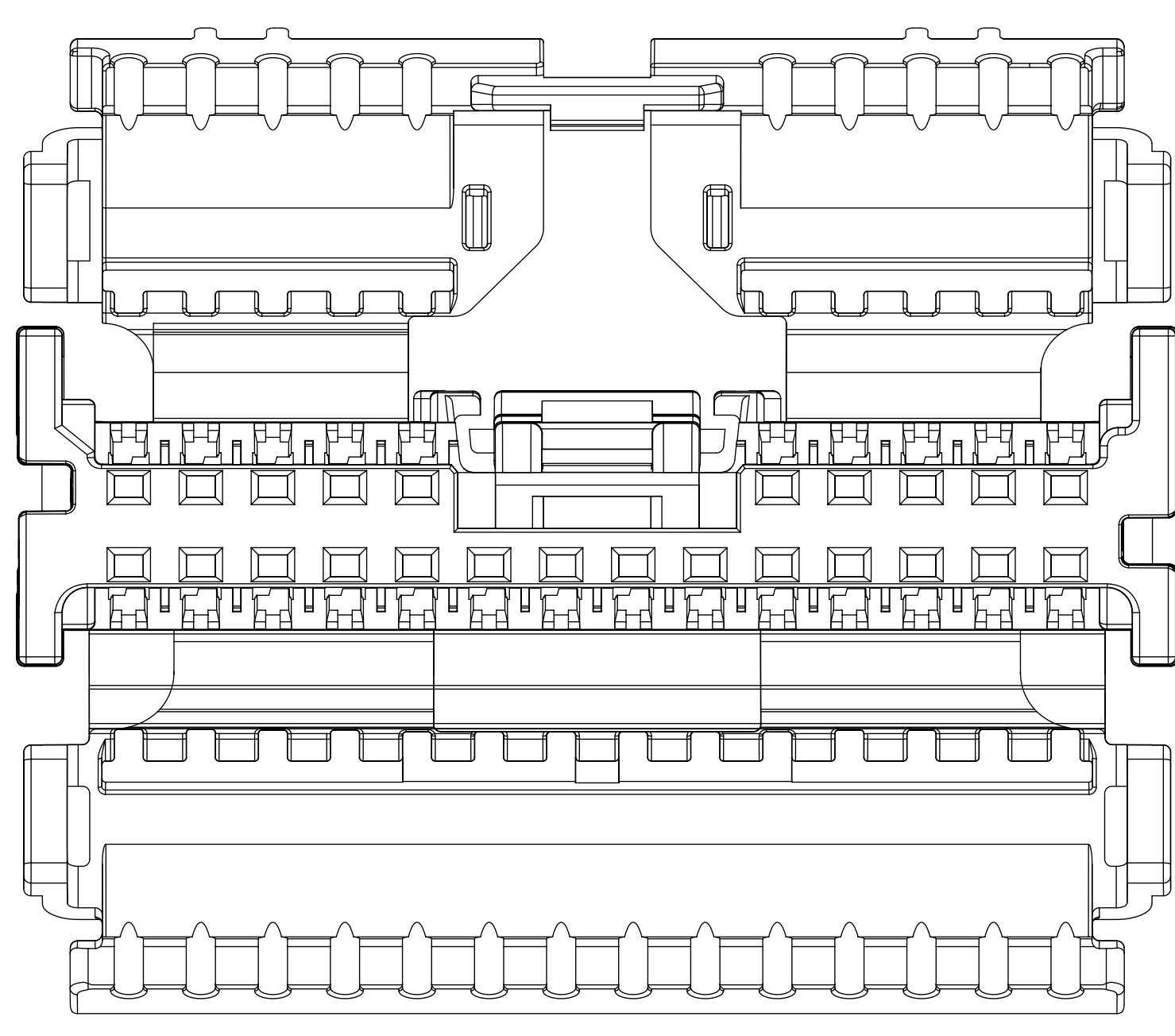

24 CIRCUIT RECEPTACLE WITHOUT LOCK BRIDGE  
POLARIZATION OPTION B

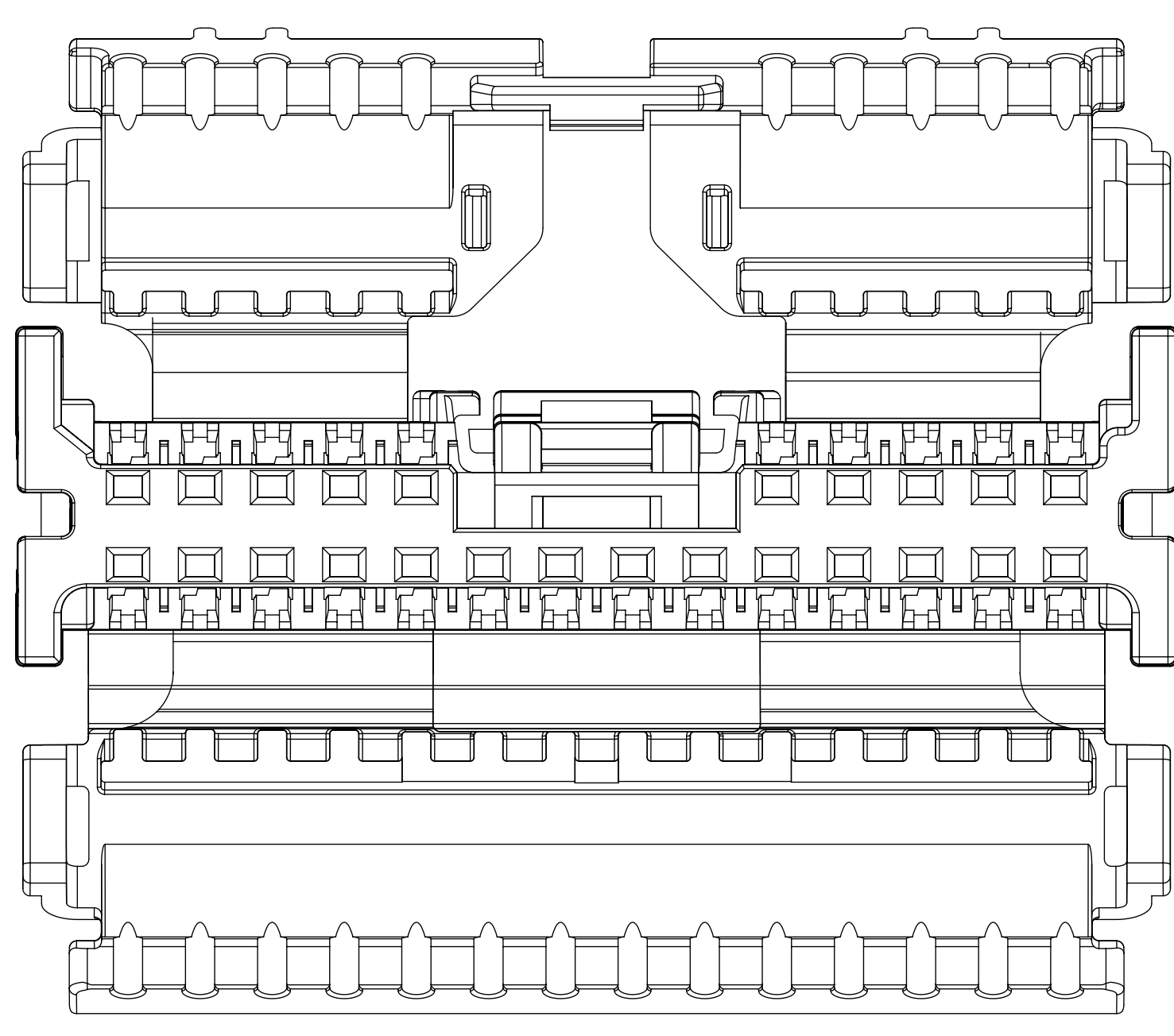

24 CIRCUIT RECEPTACLE WITHOUT LOCK BRIDGE  
POLARIZATION OPTION C

QUALITY SYMBOLS	THIS DRAWING CONTAINS INFORMATION THAT IS PROPRIETARY TO MOLEX ELECTRONIC TECHNOLOGIES, LLC AND SHOULD NOT BE USED WITHOUT WRITTEN PERMISSION
∇ = 0	EC NO: 614746 DRWN: SRUSS CHK'D: JDUNAJ REV APPR: JDUNAJ L5
∇ = 0	
∇ = 0	
∇ = 0	
∇ = 0	
∇ = 0	
∇ = 0	
∇ = 0	
∇ = 0	
∇ = 0	

GENERAL TOLERANCES (UNLESS SPECIFIED)	DIMENSION UNITS	SCALE
ANGULAR TOL ±	MM ONLY	6:1
4 PLACES ±	TCUCU	2011/03/10
3 PLACES ±	TMACHUGA	2011/03/11
2 PLACES ± 0.1	SMARCEAU	2012/05/21
1 PLACE ± 0.2		
0 PLACES ±		
DRAFT WHERE APPLICABLE MUST REMAIN WITHIN DIMENSIONS	DRAWING SIZE	THIRD ANGLE PROJECTION
	E	

INSPECTION BALLOON NUMBER	PER DRAWING REVISION: L	
LAST BALLOON USED: 17	L5	VERTICAL PITCH DIMENSION ADDED
ADDED BALLOON NUMBERS:	L4	UPDATED P/N TABLE TO SHOW MATERIAL
REMOVED BALLOON NUMBERS:	L	UPDATED 24 CKT DESCRIPTION
	REV	

**molex**

MINI50 DUAL ROW  
RECEPTACLE SALES DRAWING

PRODUCT CUSTOMER DRAWING

SERIES	MATERIAL NUMBER	CUSTOMER
34824	SEE TABLE	GENERAL MARKET
DOCUMENT NUMBER	DOC TYPE	DOC PART SHEET NUMBER
SD-34824-002	PSD	001 1 OF 4

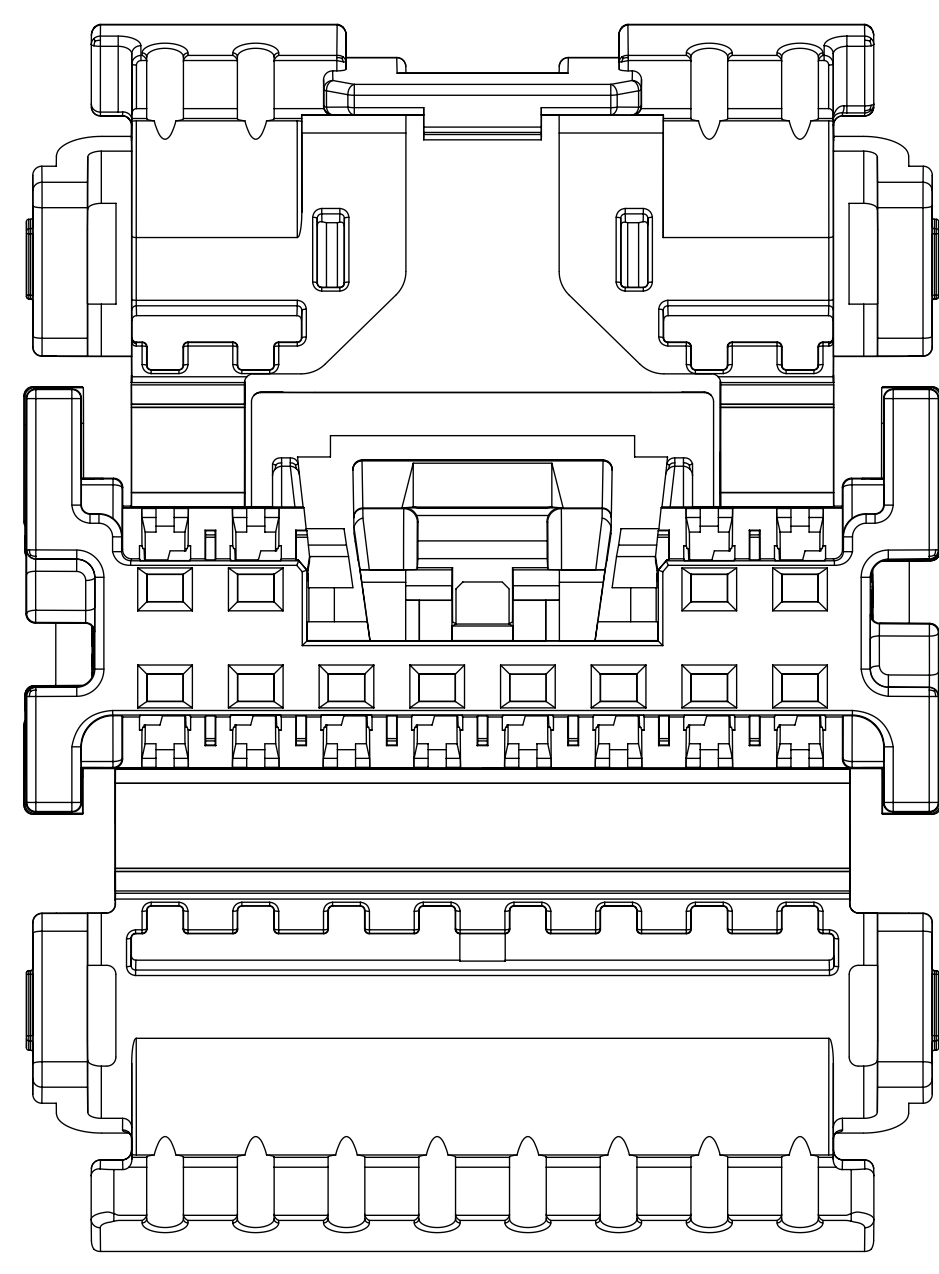

12 CIRCUIT RECEPTACLE WITH LOCK BRIDGE  
POLARIZATION OPTION A  
USCAR COMPATIBLE

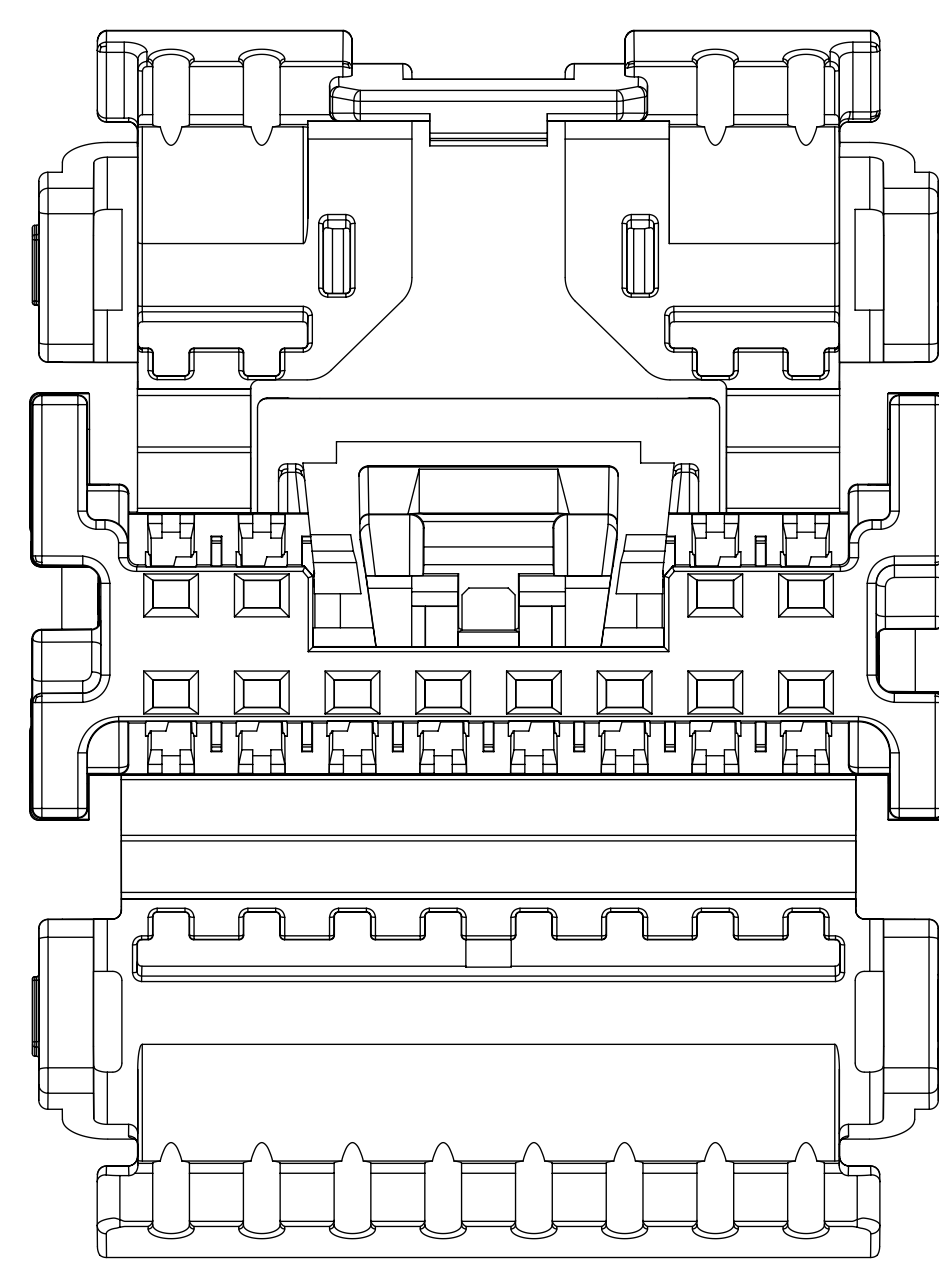

12 CIRCUIT RECEPTACLE WITH LOCK BRIDGE  
POLARIZATION OPTION B  
USCAR COMPATIBLE

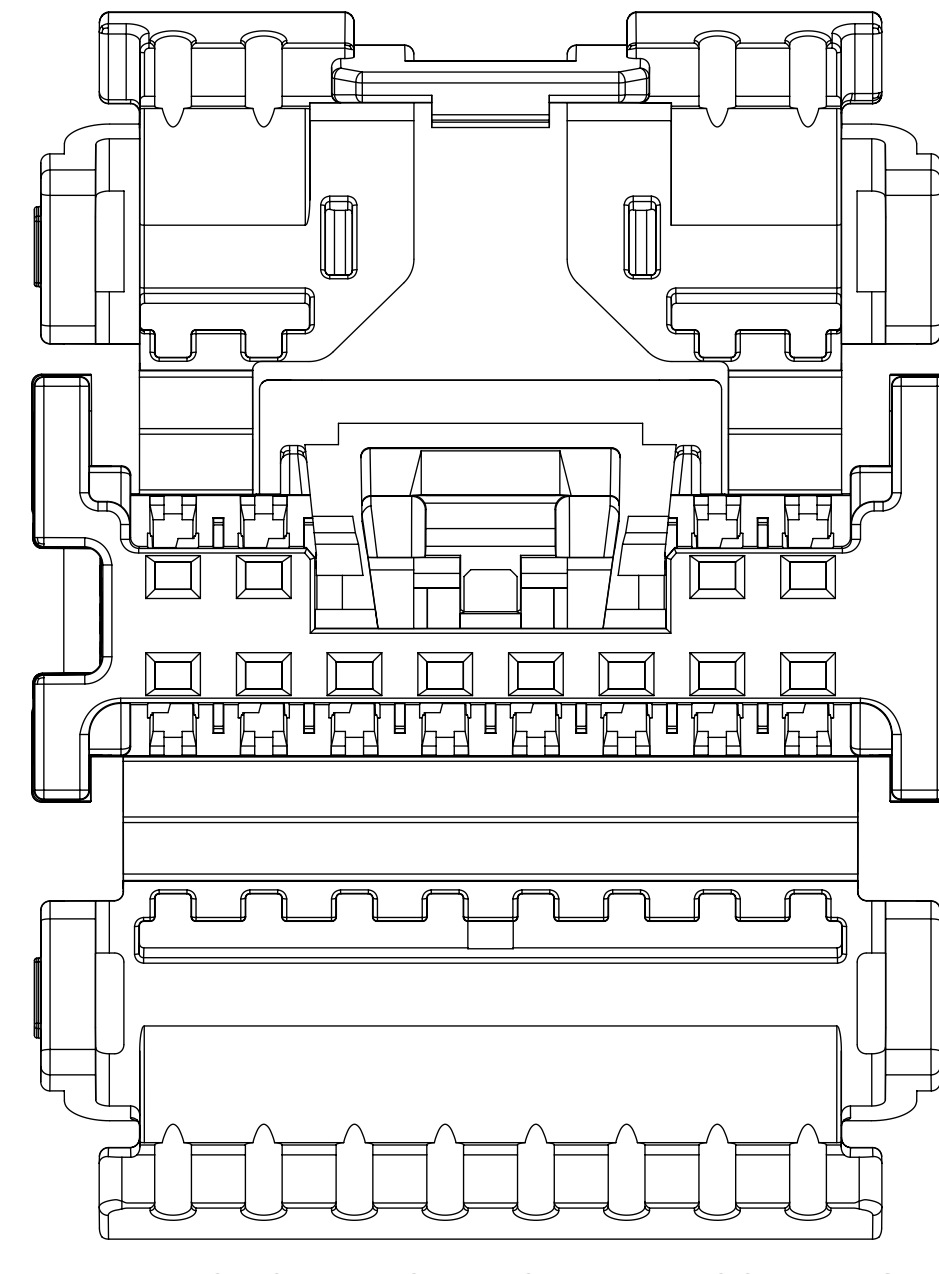

12 CIRCUIT RECEPTACLE WITH LOCK BRIDGE  
POLARIZATION OPTION C  
USCAR COMPATIBLE

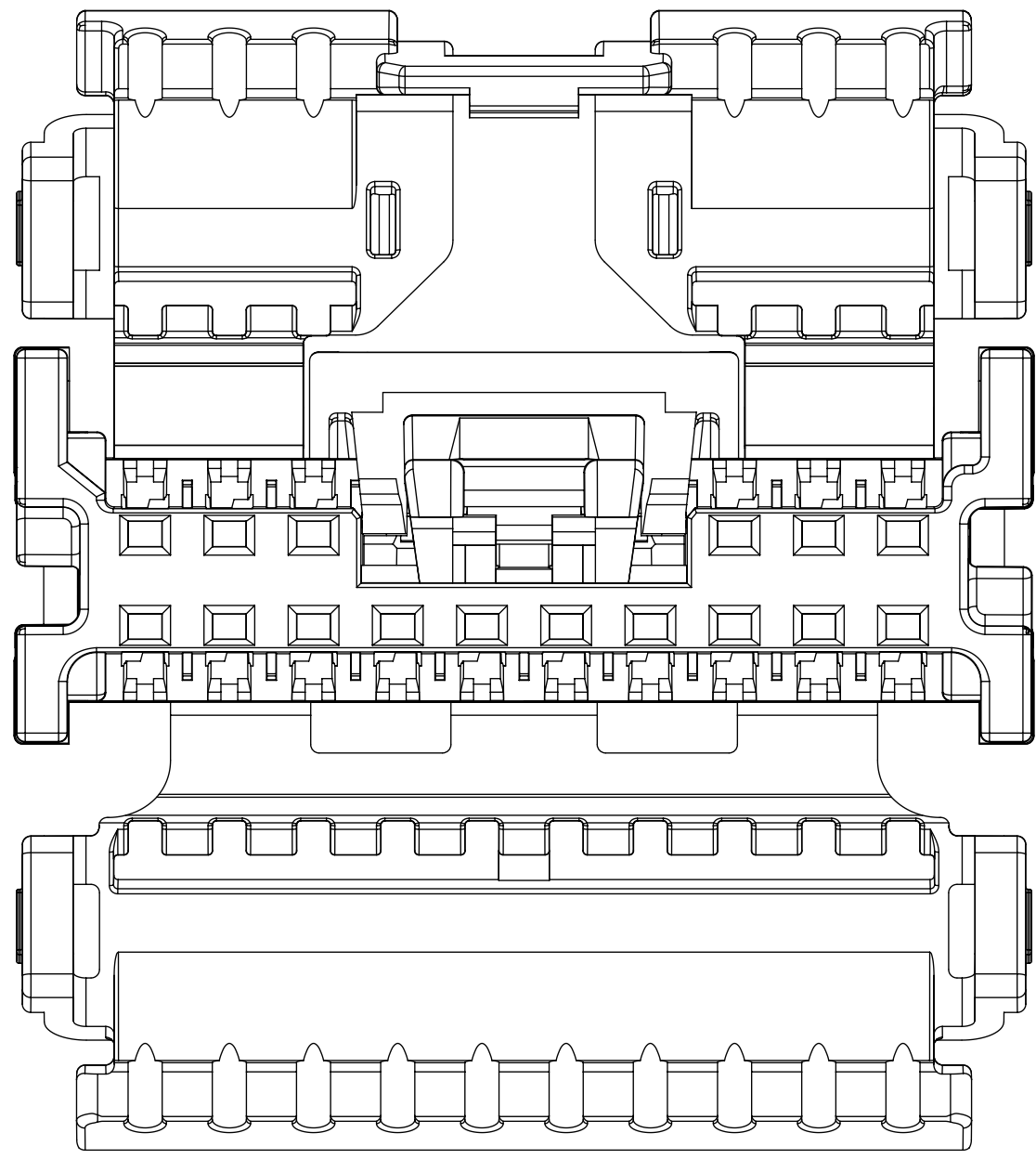

16 CIRCUIT RECEPTACLE WITH LOCK BRIDGE  
POLARIZATION OPTION A

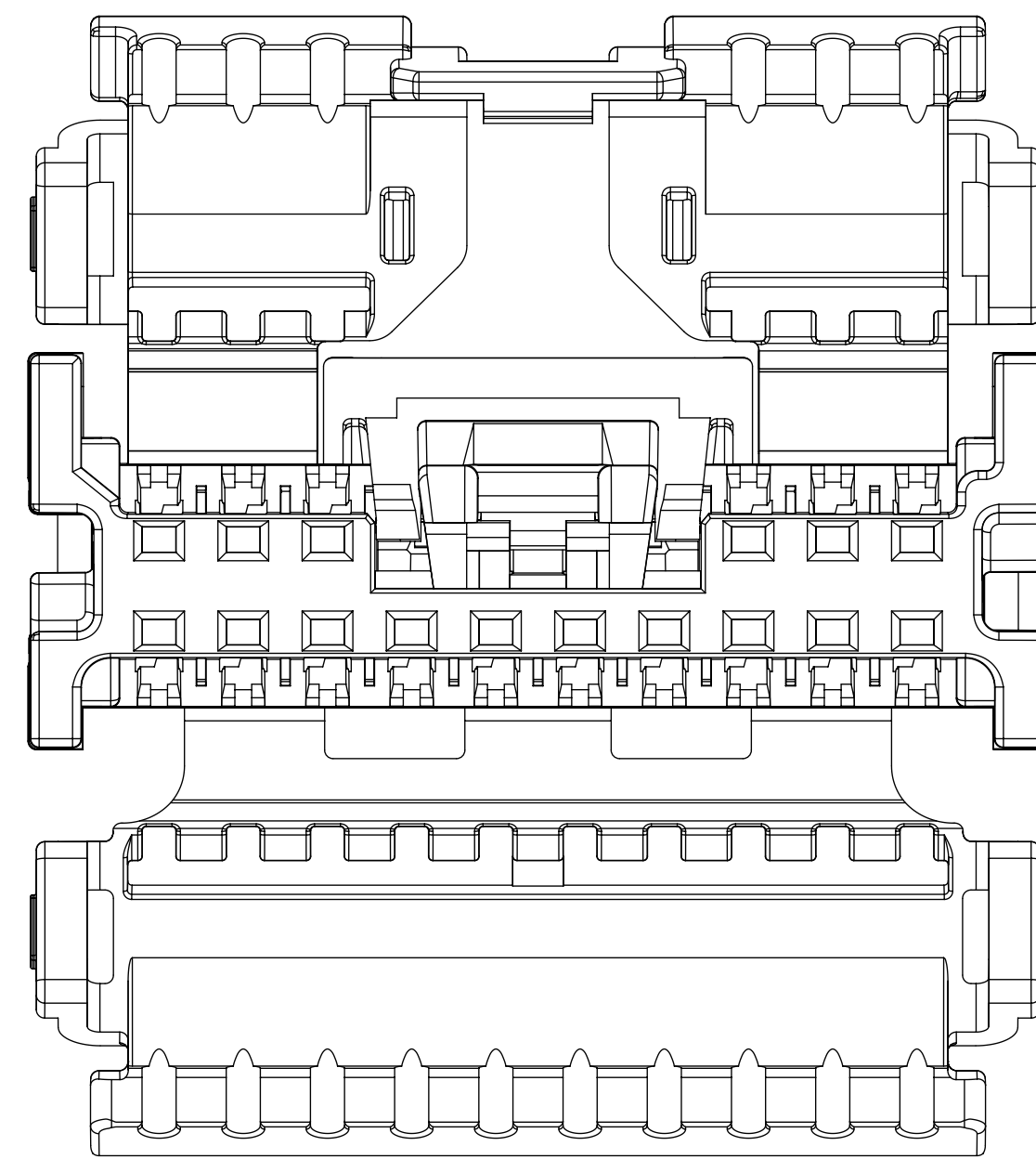

16 CIRCUIT RECEPTACLE WITH LOCK BRIDGE  
POLARIZATION OPTION B

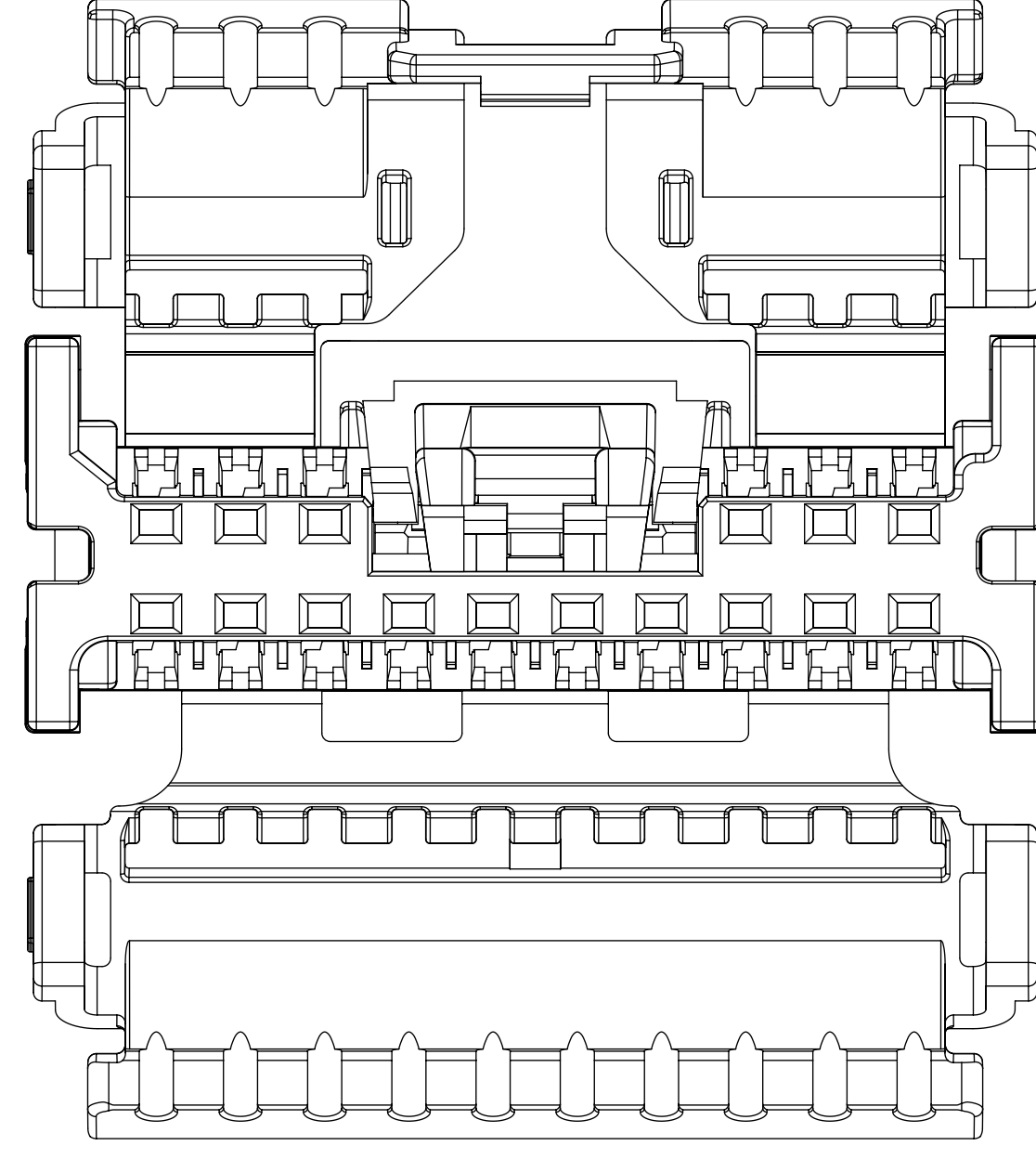

16 CIRCUIT RECEPTACLE WITH LOCK BRIDGE  
POLARIZATION OPTION C

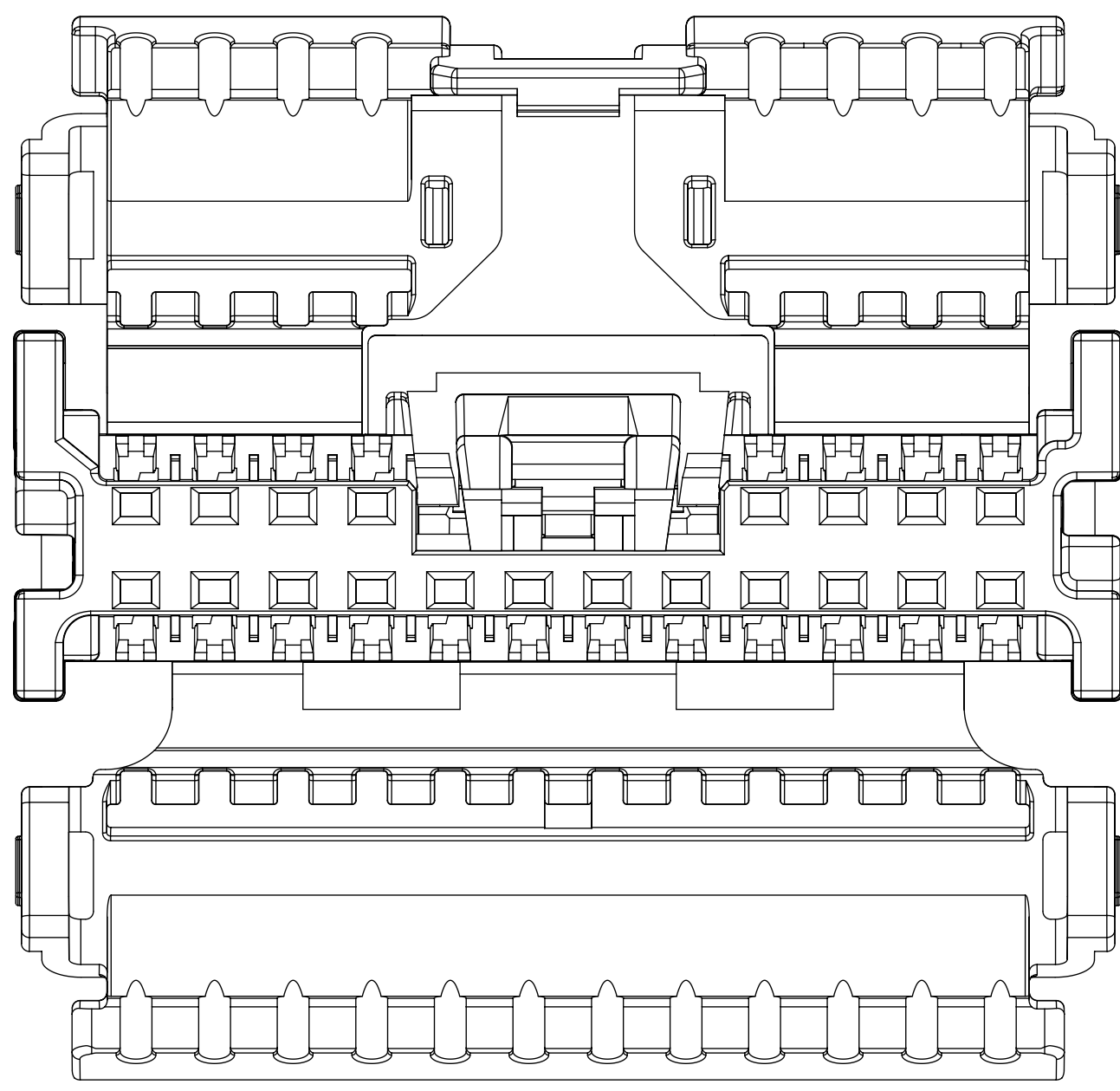

20 CIRCUIT RECEPTACLE WITH LOCK BRIDGE  
POLARIZATION OPTION A

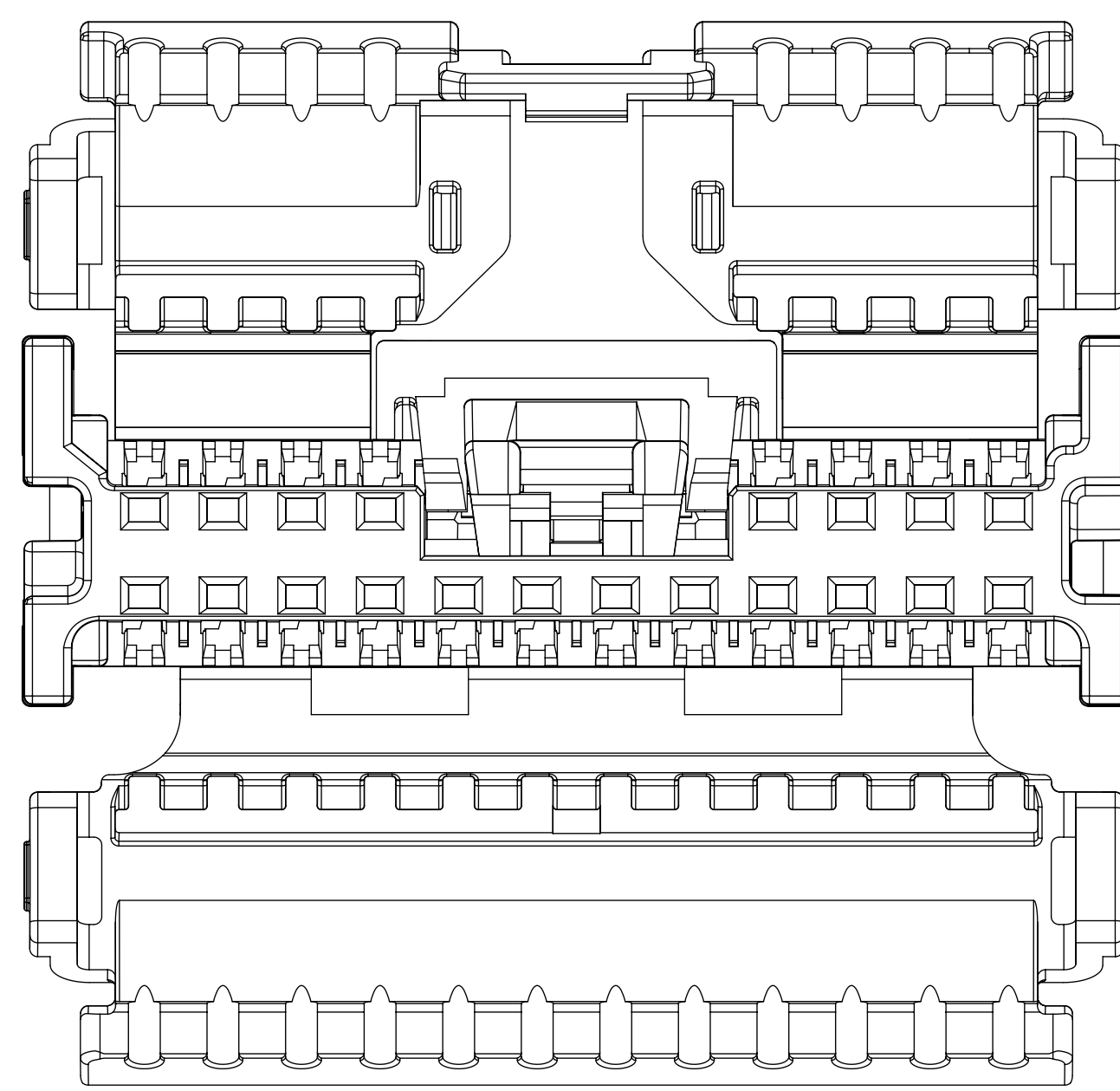

20 CIRCUIT RECEPTACLE WITH LOCK BRIDGE  
POLARIZATION OPTION B

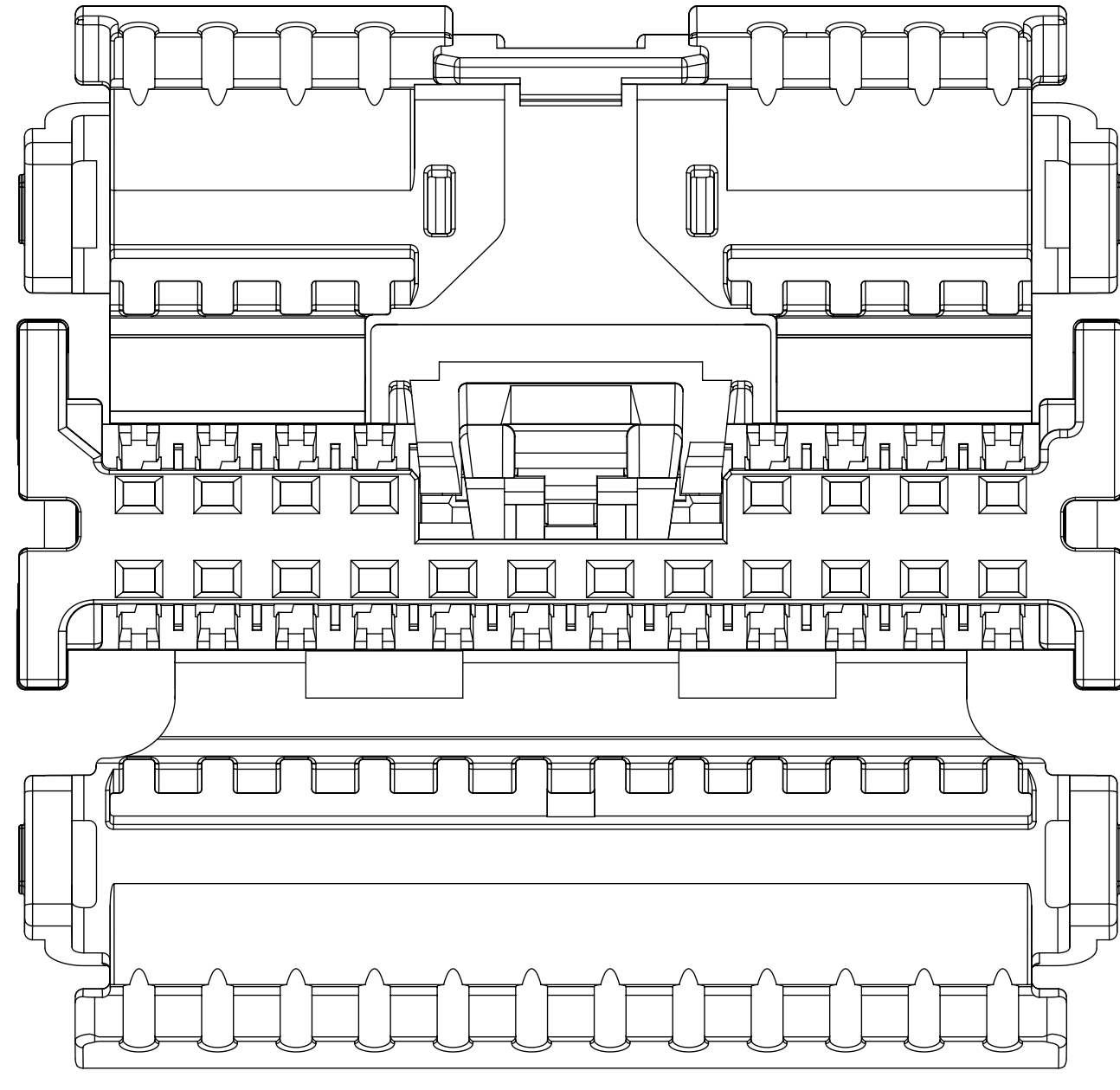

20 CIRCUIT RECEPTACLE WITH LOCK BRIDGE  
POLARIZATION OPTION C

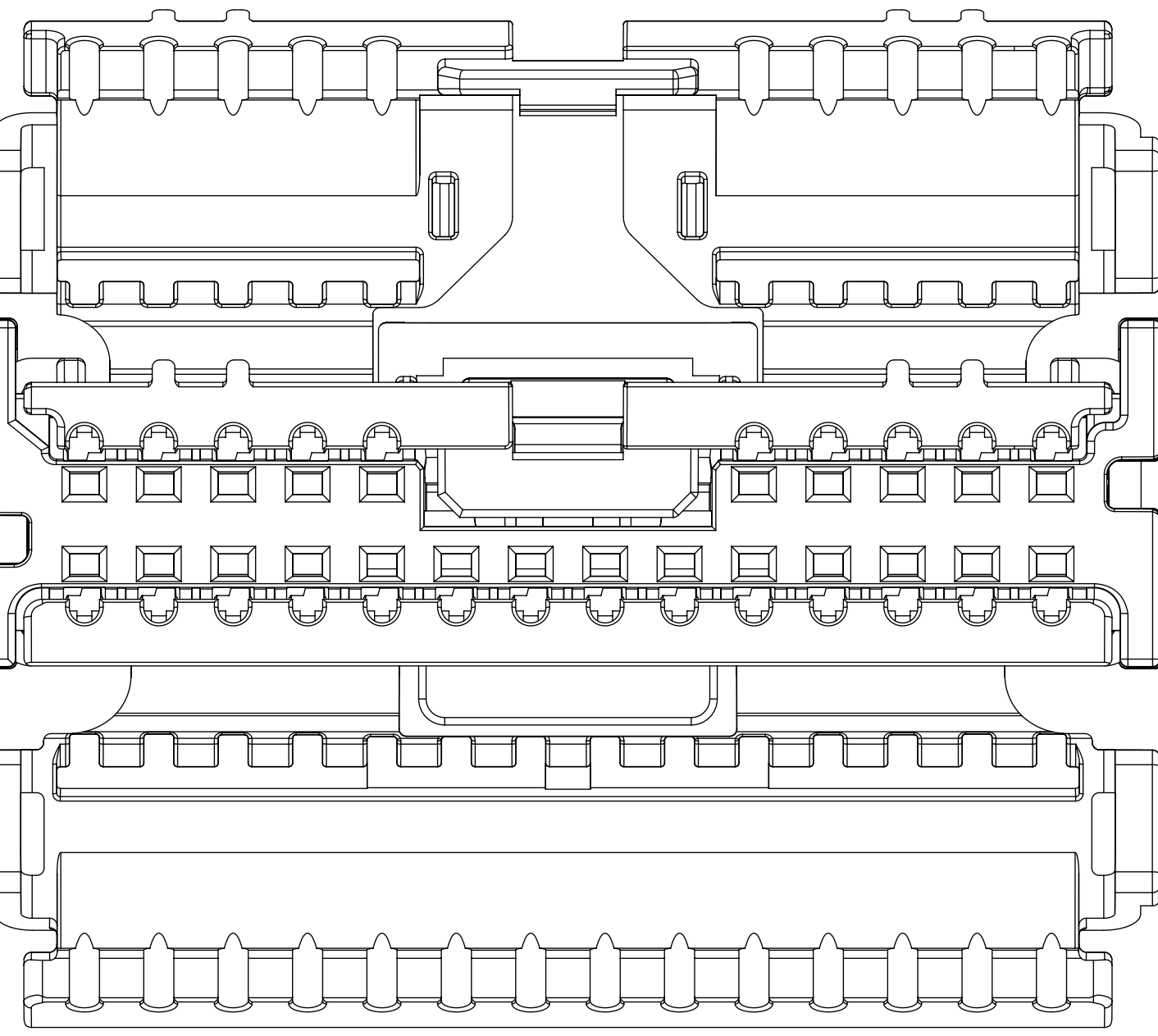

24 CIRCUIT RECEPTACLE WITH LOCK BRIDGE  
POLARIZATION OPTION A

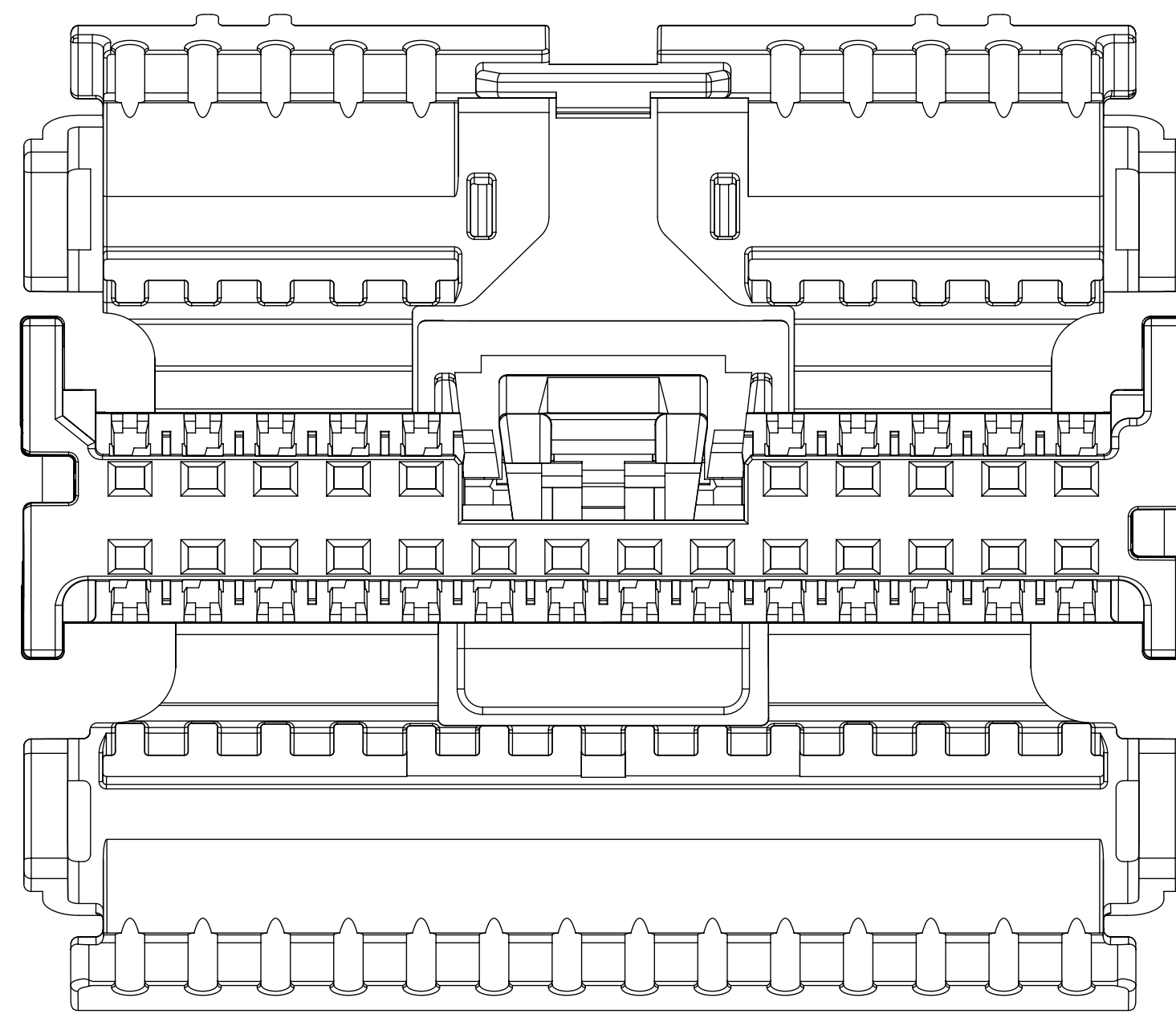

24 CIRCUIT RECEPTACLE WITH LOCK BRIDGE  
POLARIZATION OPTION B

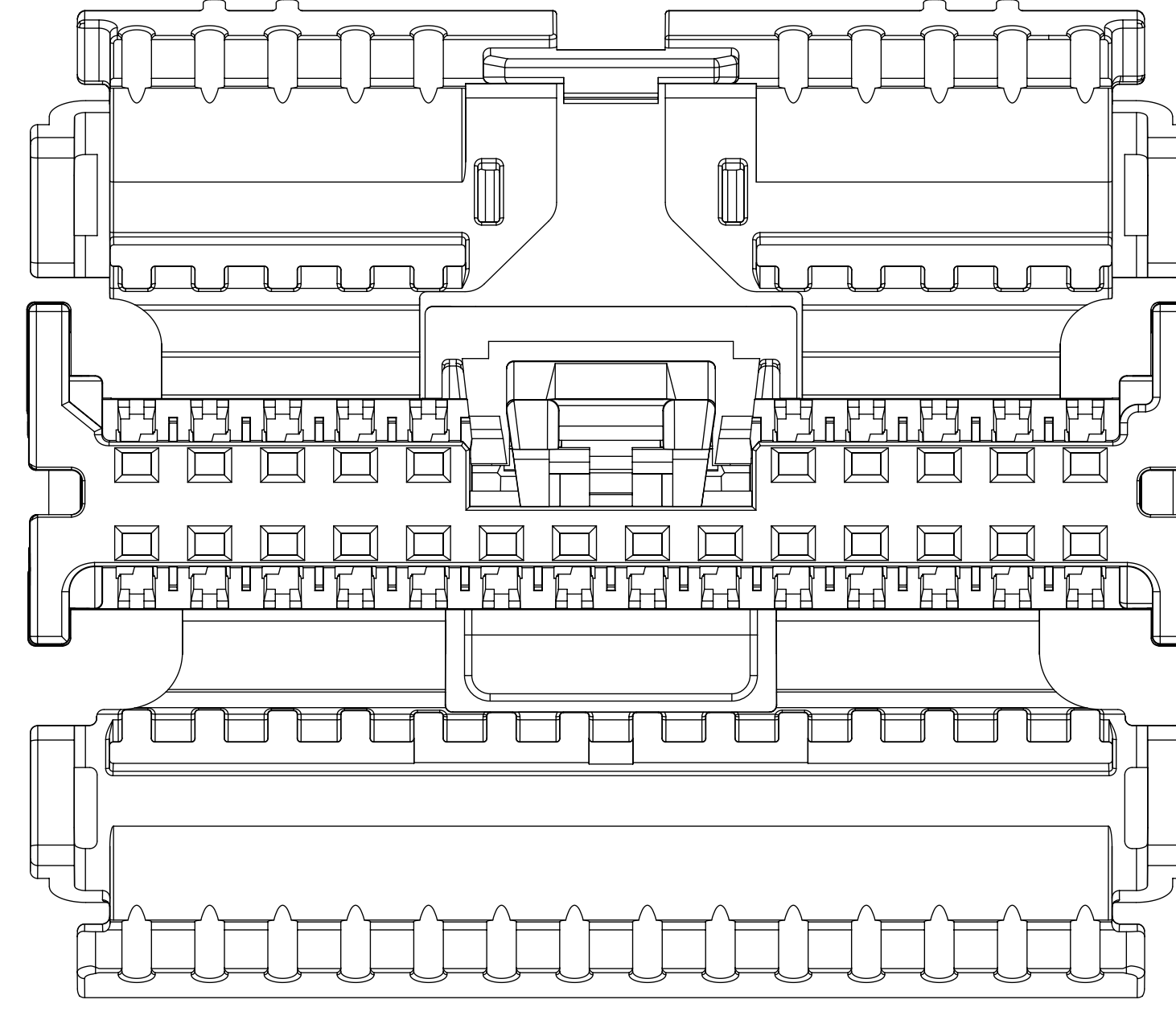

24 CIRCUIT RECEPTACLE WITH LOCK BRIDGE  
POLARIZATION OPTION C

<b>QUALITY SYMBOLS</b> 	THIS DRAWING CONTAINS INFORMATION THAT IS PROPRIETARY TO MOLEX ELECTRONIC TECHNOLOGIES, LLC AND SHOULD NOT BE USED WITHOUT WRITTEN PERMISSION										
	2019/03/27	GENERAL TOLERANCES (UNLESS SPECIFIED)		DIMENSION UNITS	SCALE						
	2019/03/29	ANGULAR TOL ± °		MM ONLY	6:1						
	2019/03/29	4 PLACES ±	TCUCU		DATE	2011/03/10					
		3 PLACES ±	TMACHUGA		DATE	2011/03/11					
		2 PLACES ± 0.1	SMARCEAU		DATE	2012/05/21					
		1 PLACE ± 0.2	DRAWING SIZE		THIRD ANGLE PROJECTION	E					
		0 PLACES ±	DRAFT WHERE APPLICABLE MUST REMAIN WITHIN DIMENSIONS								
	EC NO: 614746	DRWN: SRUSS	CHKD: JDUNAJ	APPR: JDUNAJ	SERIES		MATERIAL NUMBER	CUSTOMER			
	L5			34824		SEE TABLE		GENERAL MARKET			
RELEASE STATUS   P1		RELEASE DATE	2019/03/29	20:37:18	DOCUMENT NUMBER		DOC TYPE	DOC PART	SHEET NUMBER		
					SD-34824-002		PSD	001	2 OF 4		



(NON-BRIDGED OPTION SHOWN BELOW)

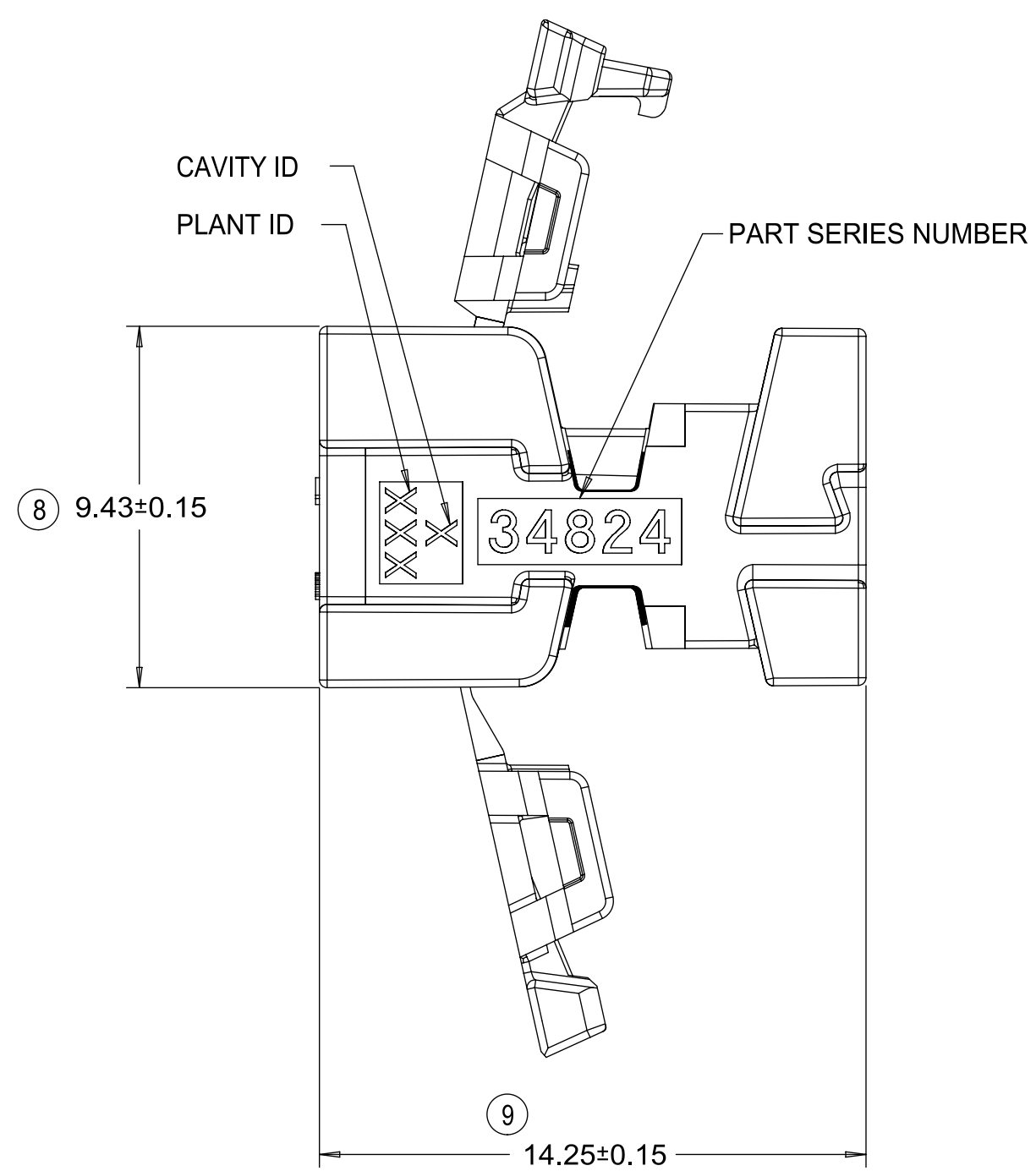

\*NOTE: DIM 9 & DIM 12 TOLERANCE IS +0.30/-0.15 FOR THE FOLLOWING P/NS:  
 34824-0164/5/6; 34824-1164/5/6  
 34824-0204/5/6; 34824-1204/5/6  
 34824-0244/5/6; 34824-1244/5/6

(BRIDGED OPTION SHOWN BELOW)

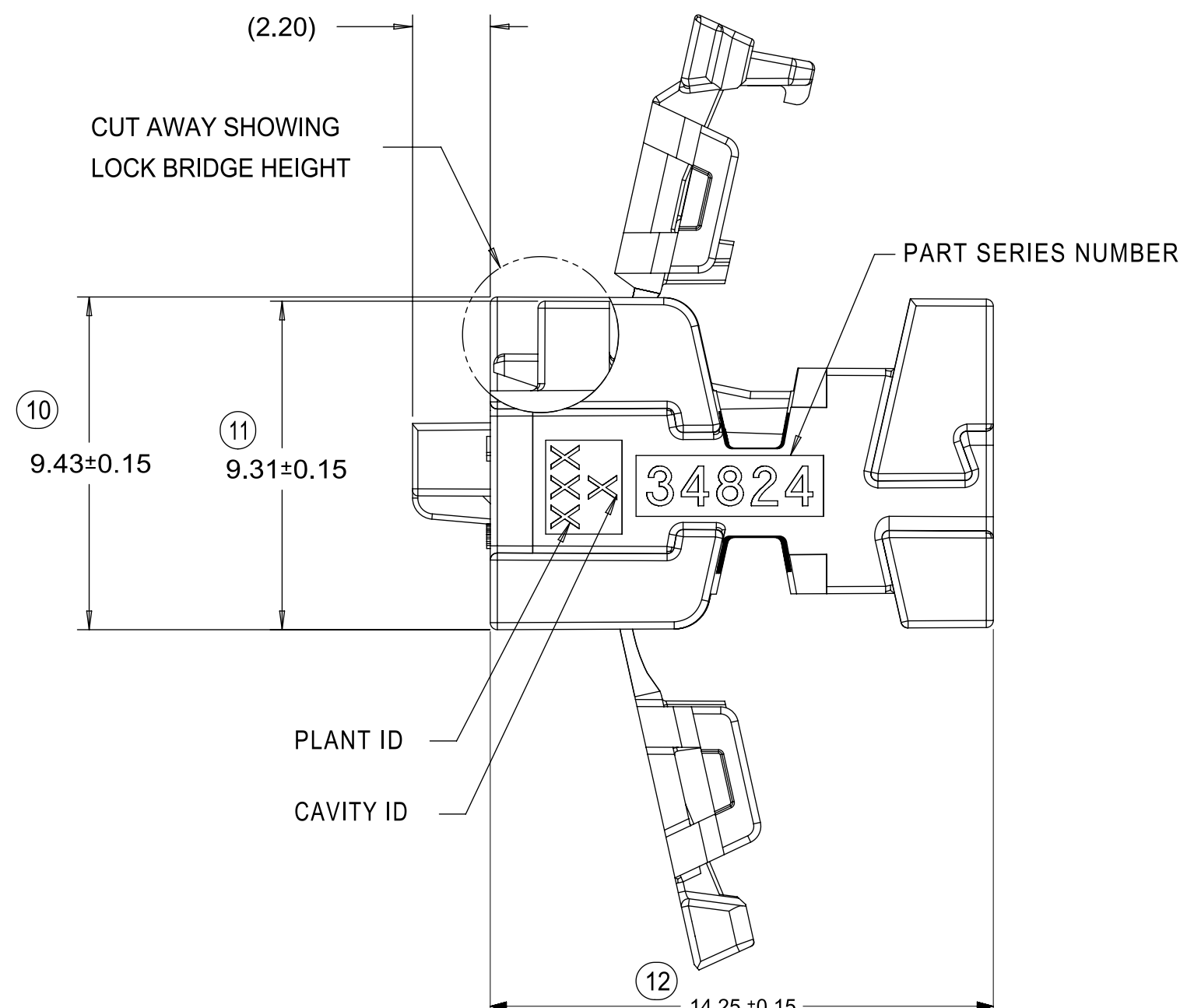

\*NOTE: DIM 9 & DIM 12 TOLERANCE IS +0.30/-0.15 FOR THE FOLLOWING P/NS:  
 34824-0164/5/6; 34824-1164/5/6  
 34824-0204/5/6; 34824-1204/5/6  
 34824-0244/5/6; 34824-1244/5/6

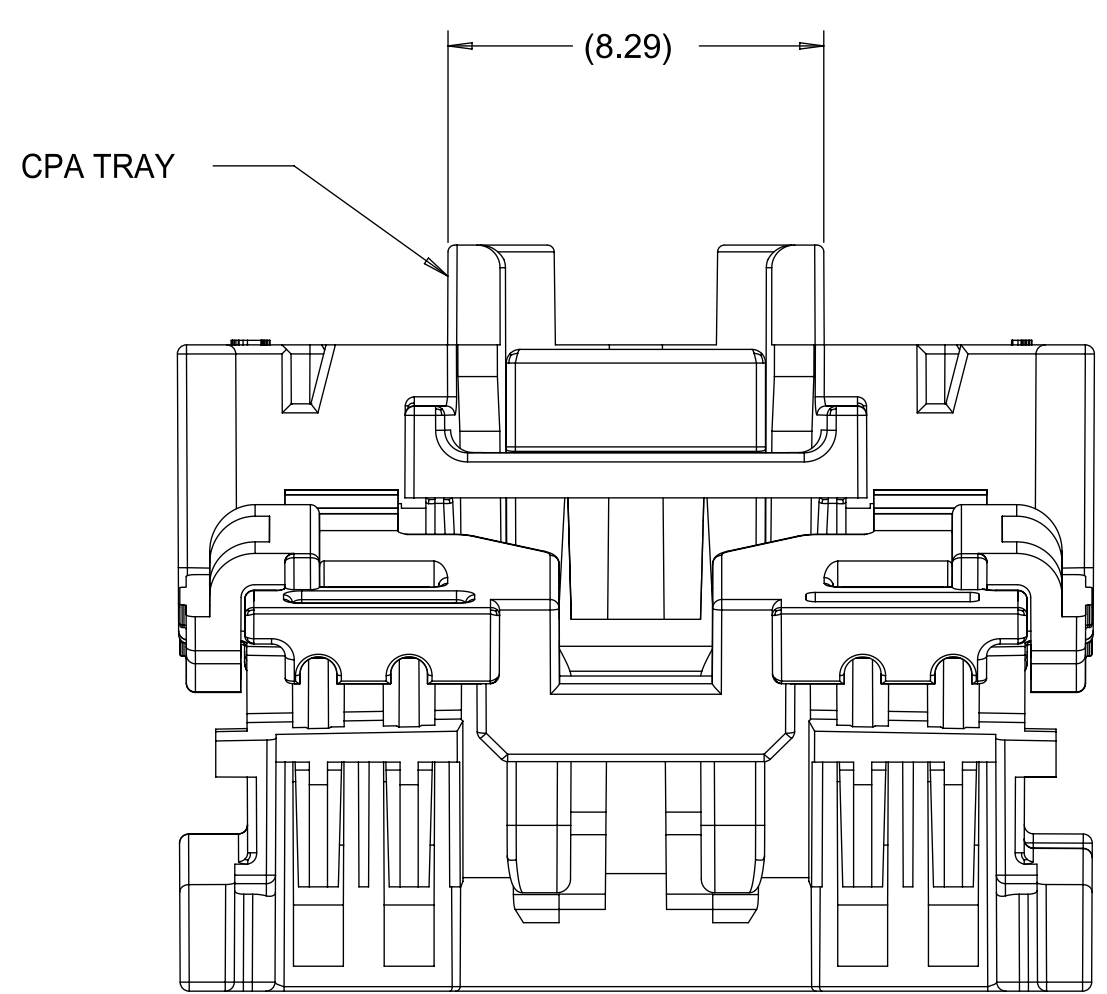

(BRIDGED OPTION SHOWN)

### 12 CIRCUIT USCAR COMPATIBLE RECEPTACLE

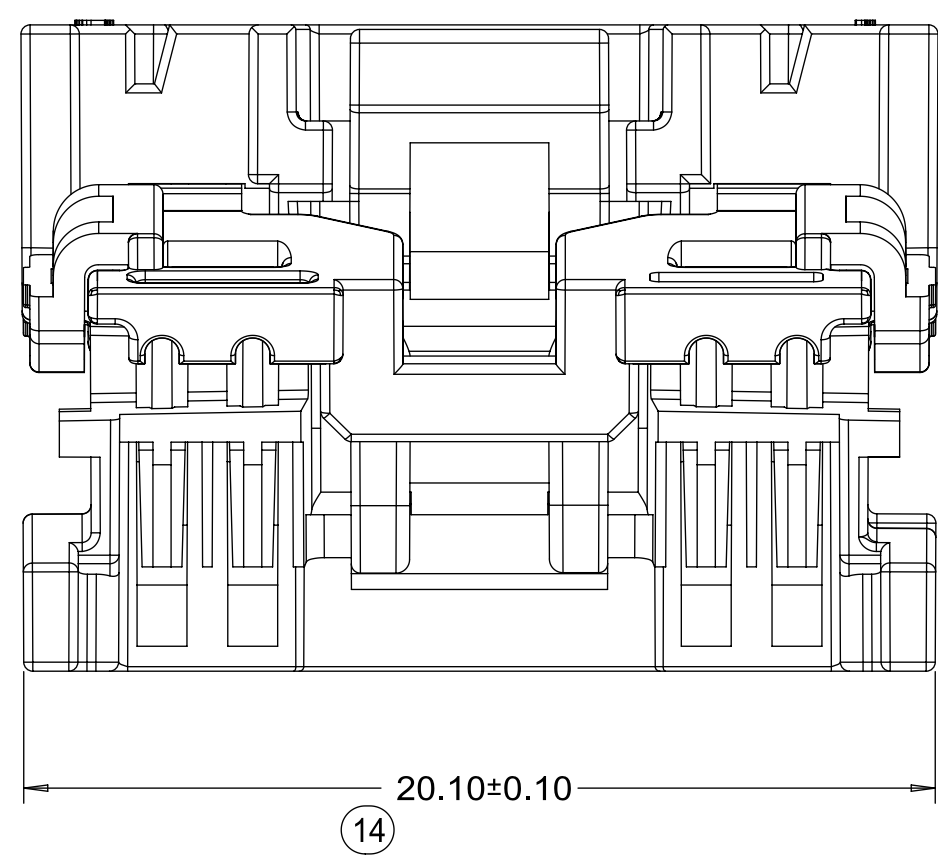

### 16 CIRCUIT RECEPTACLE

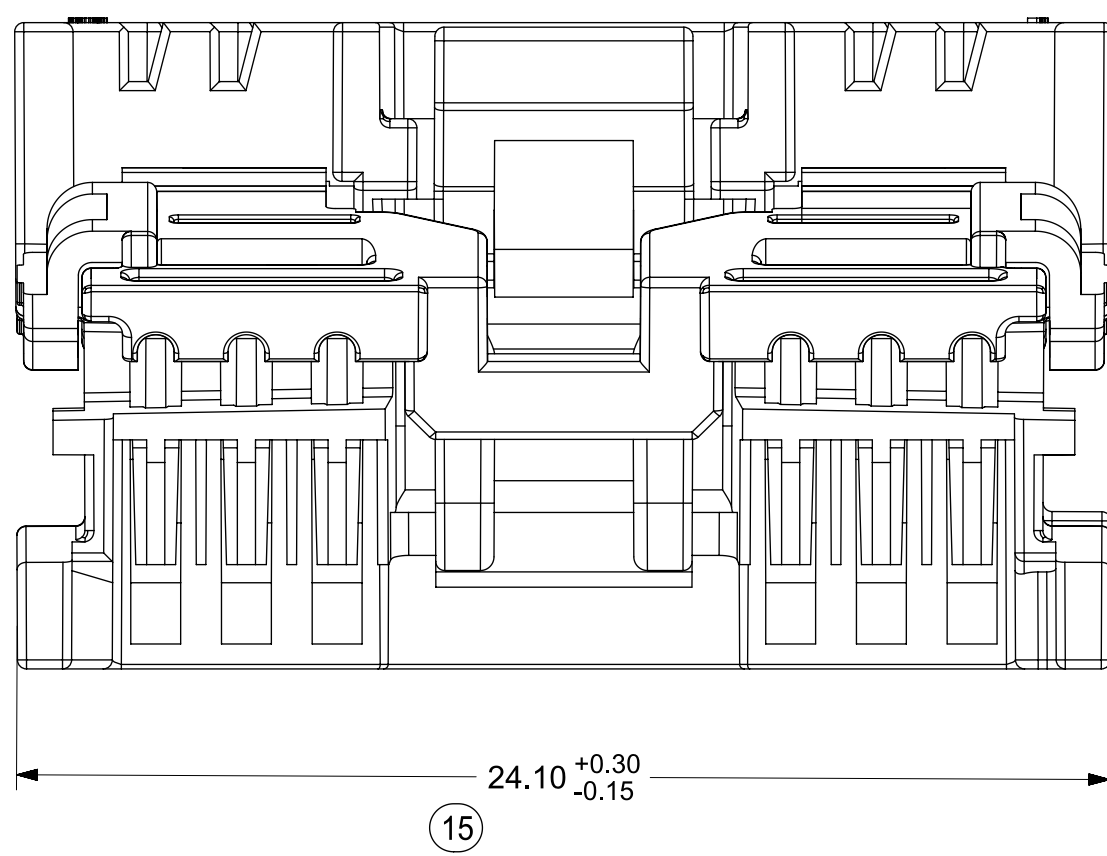

### 20 CIRCUIT RECEPTACLE

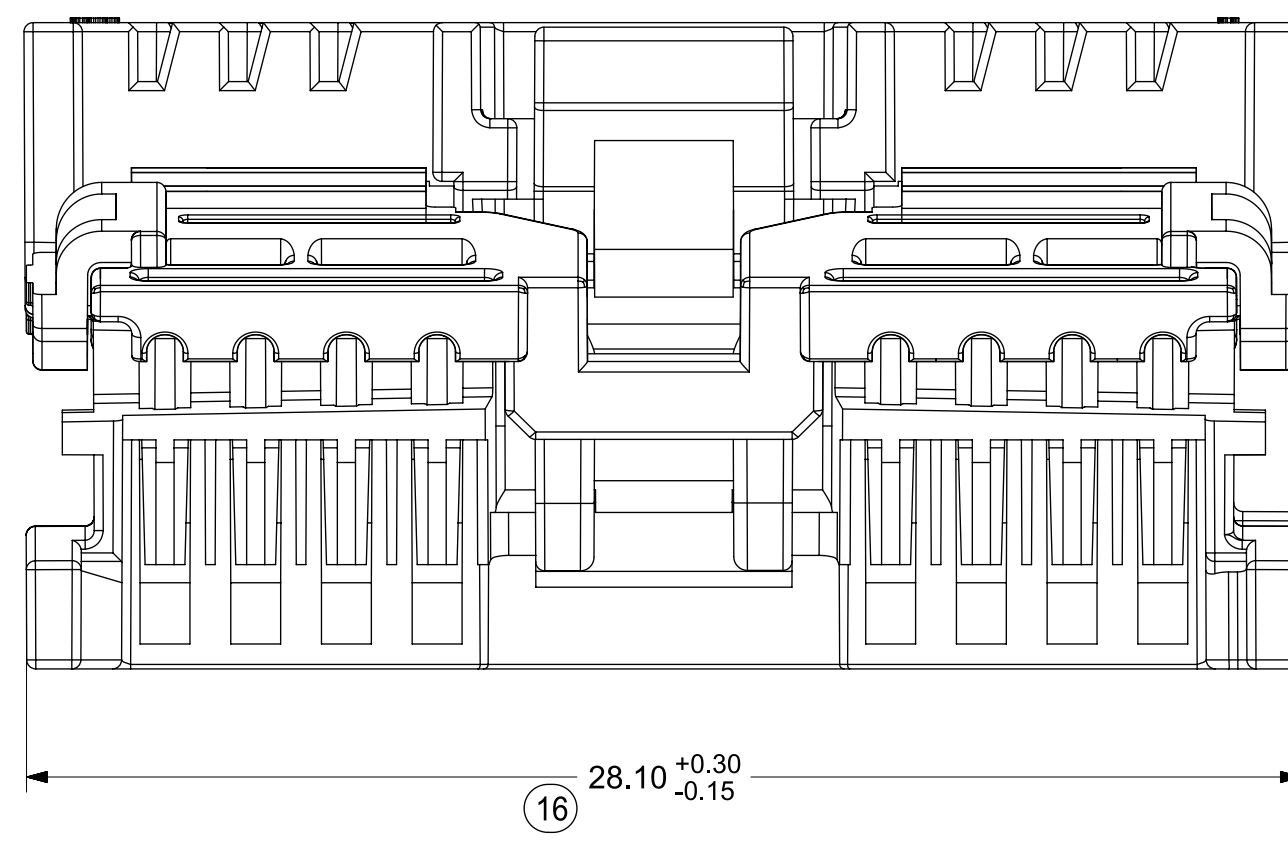

### 24 CIRCUIT RECEPTACLE

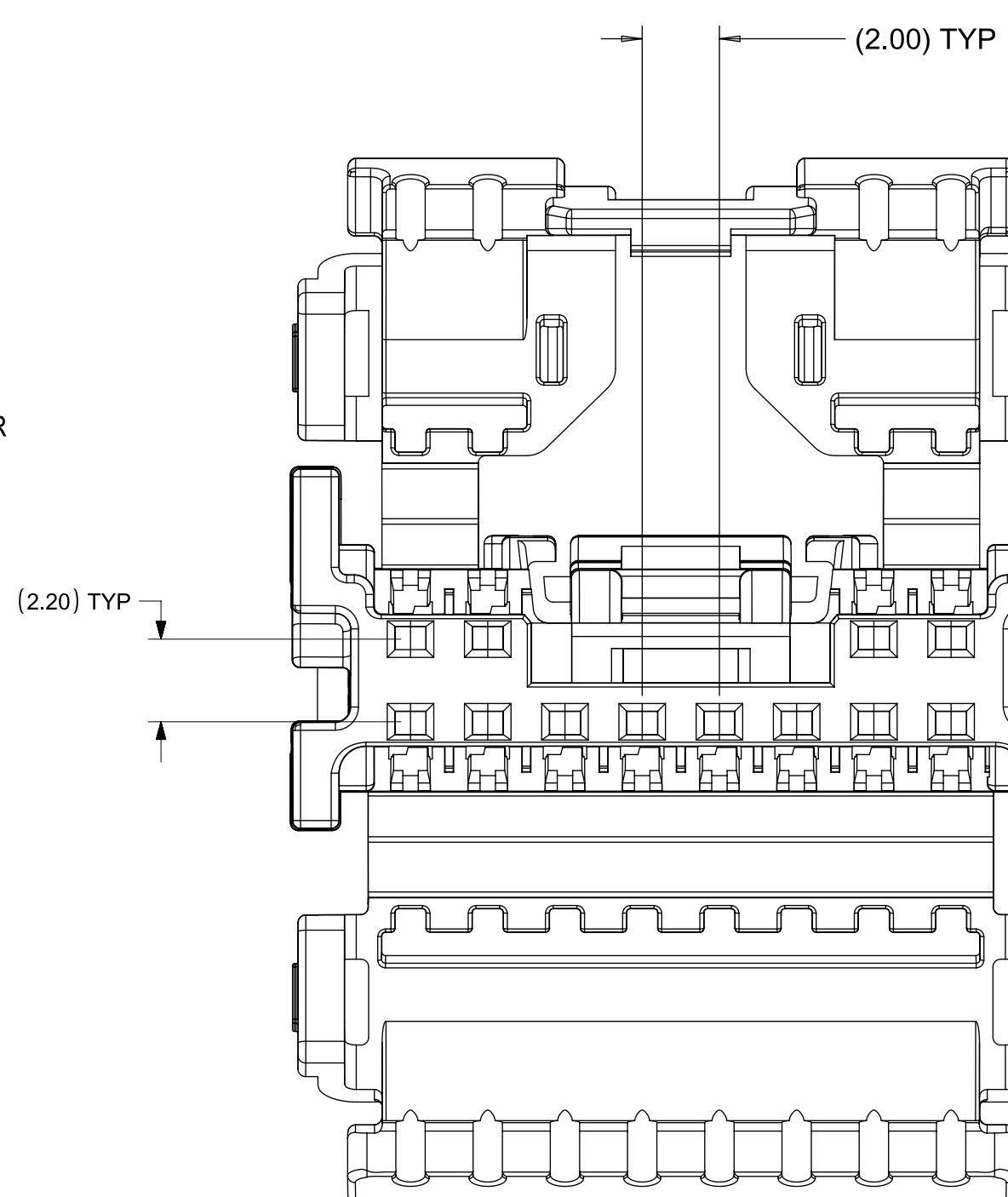
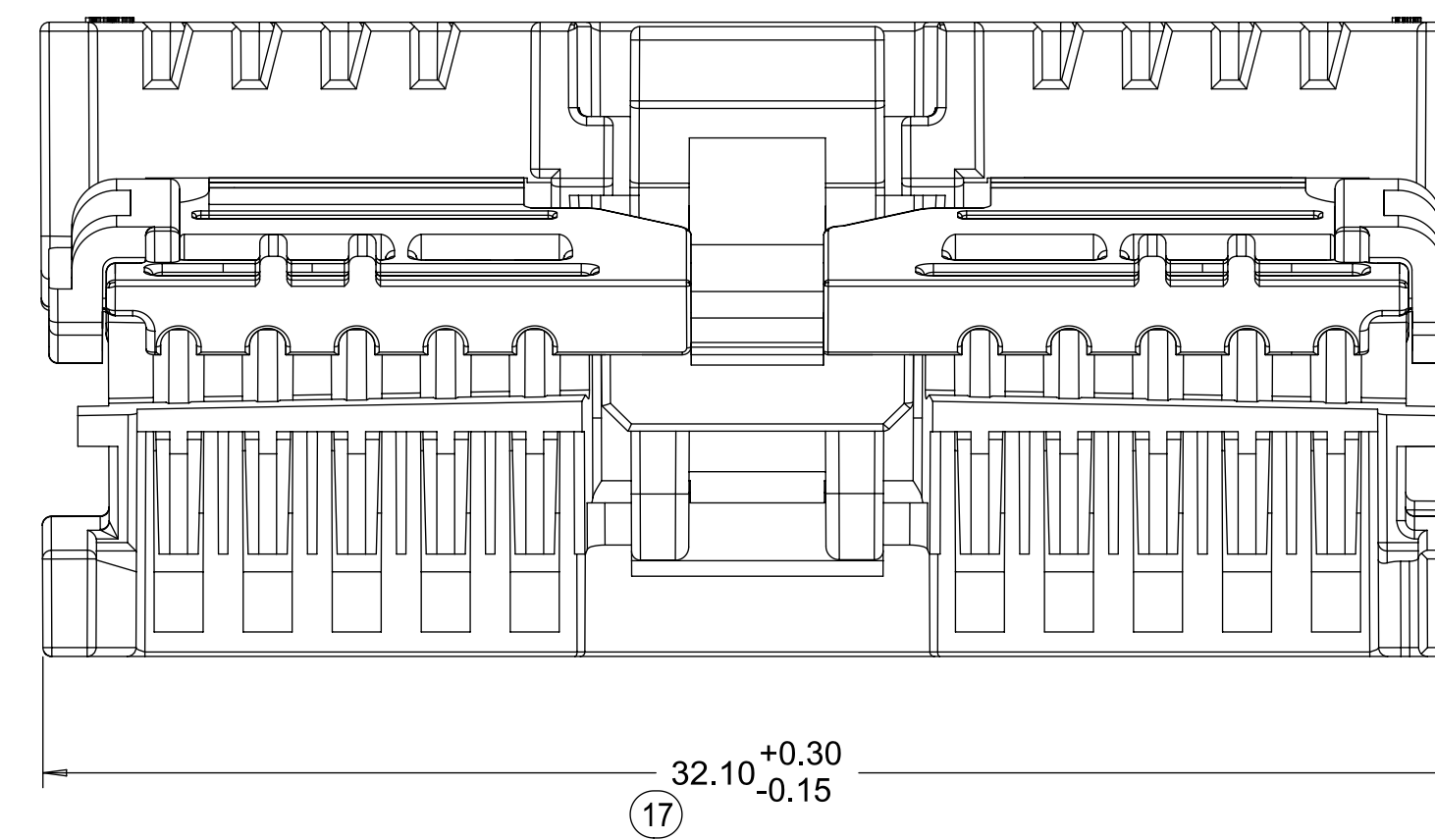

HINGES CLOSED (BRIDGED/NON-BRIDGED)

PASS THRU DIAMETER  $\varnothing 24.18$   
 1 mm ADDITIONAL CLEARANCE ADDED TO TIGHTEST FIT CIRCLE

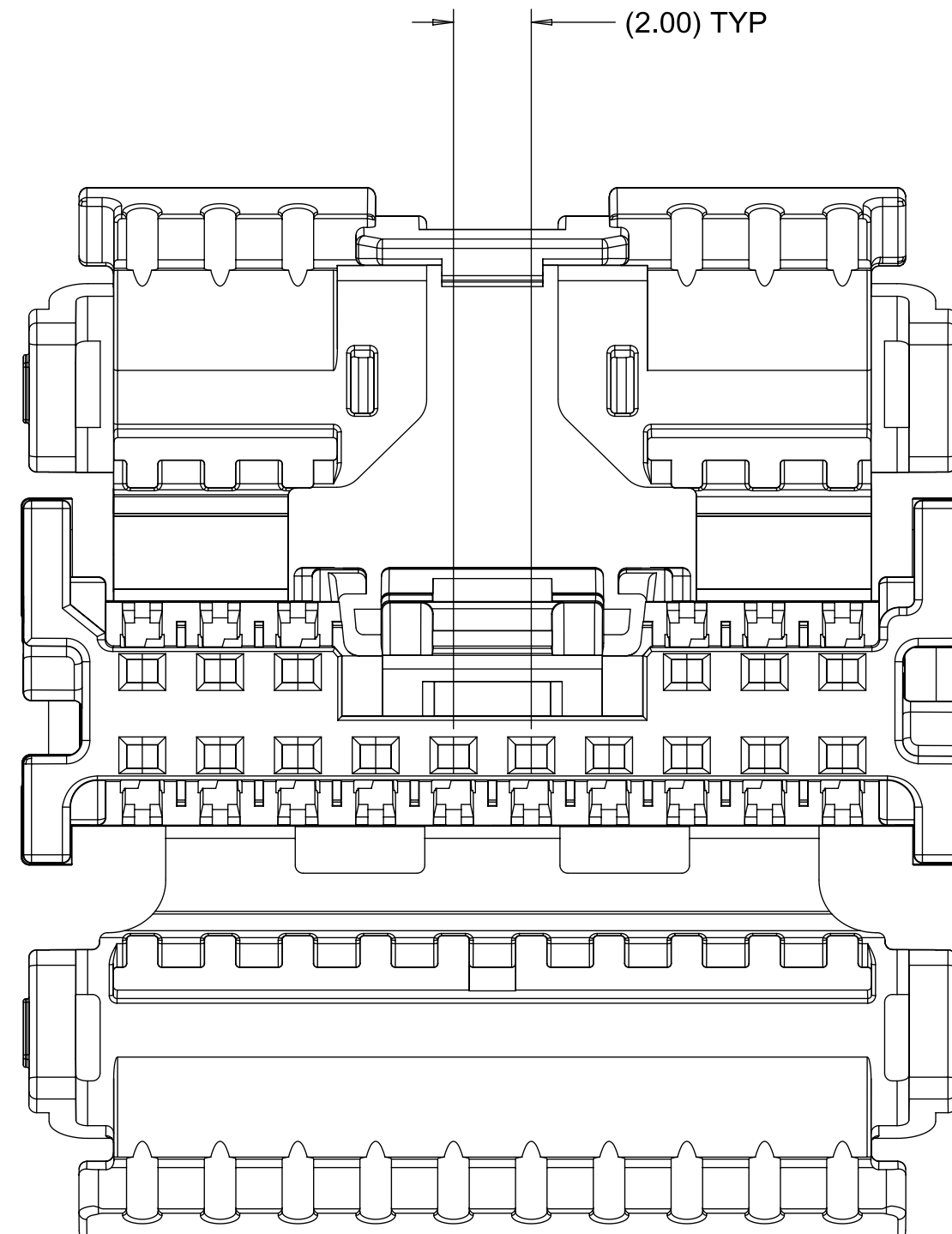

HINGES CLOSED (BRIDGED/NON-BRIDGED)

PASS THRU DIAMETER  $\varnothing 27.88$   
 1 mm ADDITIONAL CLEARANCE ADDED TO TIGHTEST FIT CIRCLE

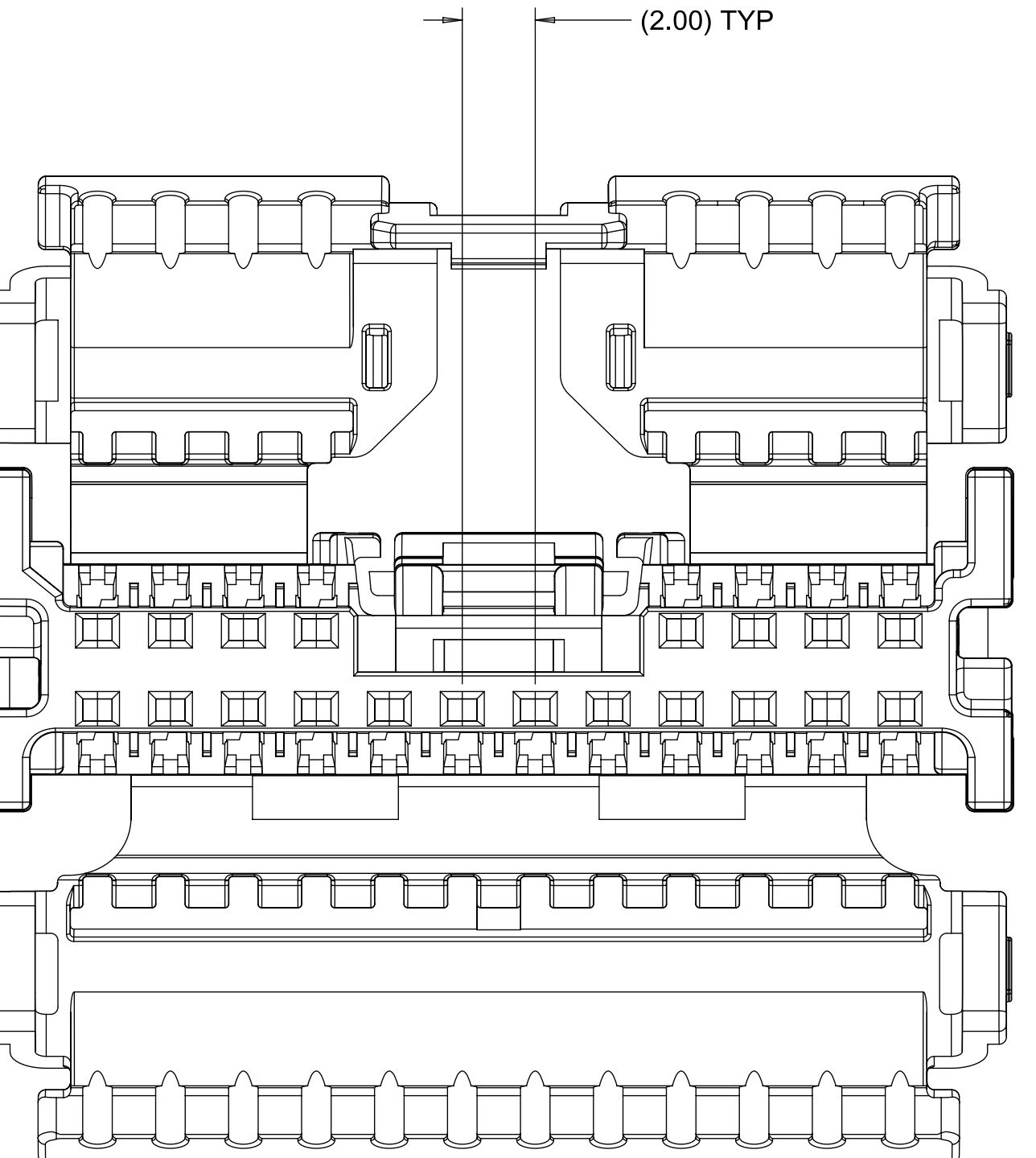

HINGES CLOSED (BRIDGED/NON-BRIDGED)

PASS THRU DIAMETER  $\varnothing 31.64$   
 1 mm ADDITIONAL CLEARANCE ADDED TO TIGHTEST FIT CIRCLE

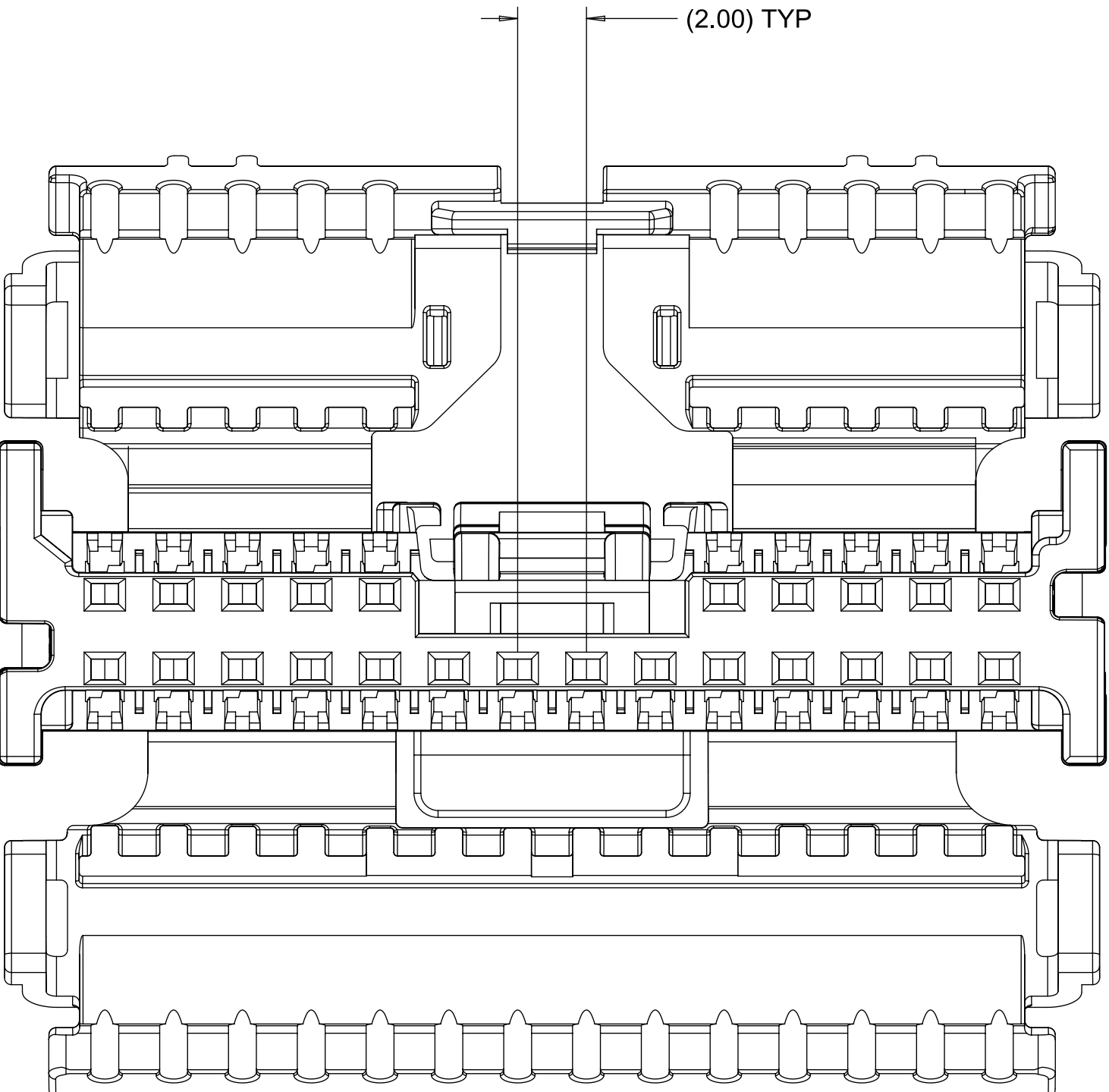

HINGES CLOSED (BRIDGED/NON-BRIDGED)

PASS THRU DIAMETER  $\varnothing 35.48$   
 1 mm ADDITIONAL CLEARANCE ADDED TO TIGHTEST FIT CIRCLE

12 CKT RECEPTACLE SHOWN BELOW 16, 20, AND 24 CKT RECEPTACLE HAS SIMILAR CIRCUIT ID LOCATION

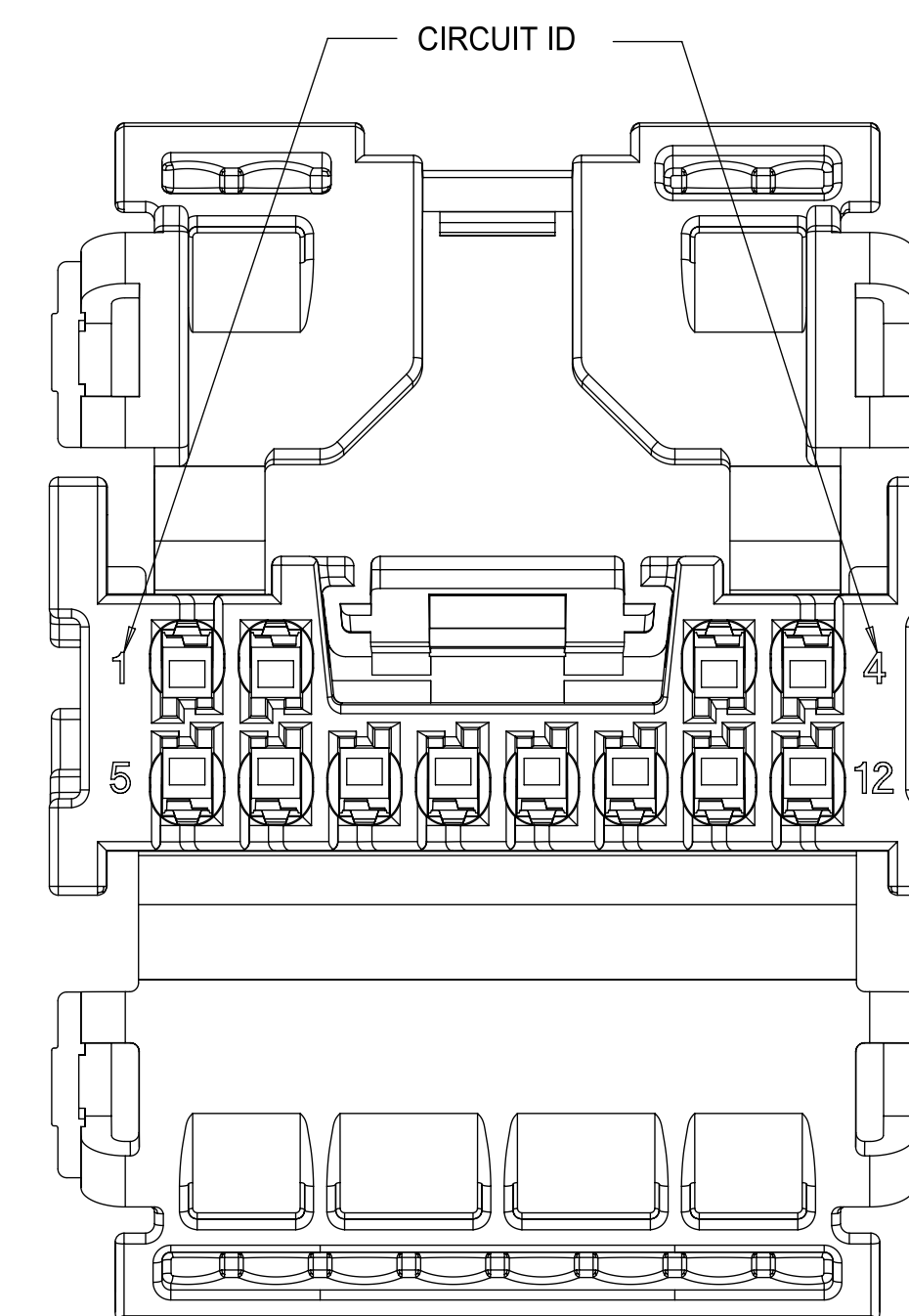

HINGES CLOSED

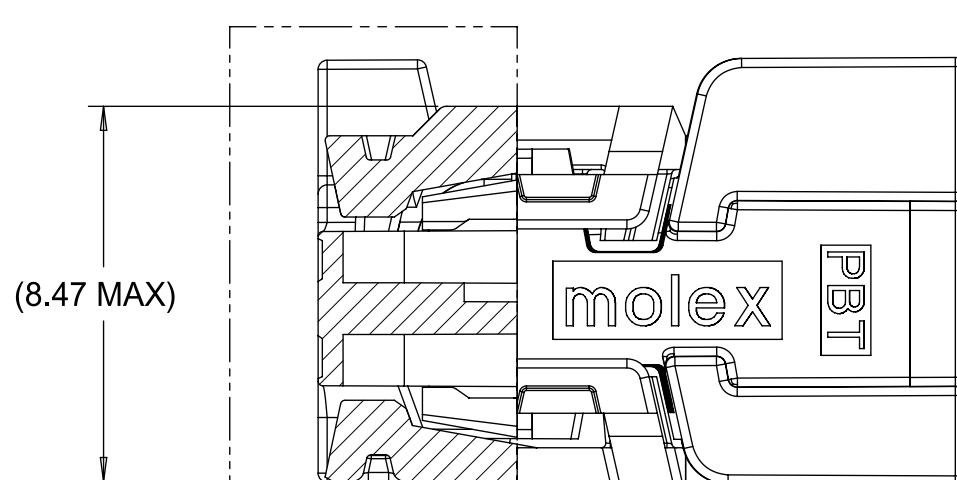
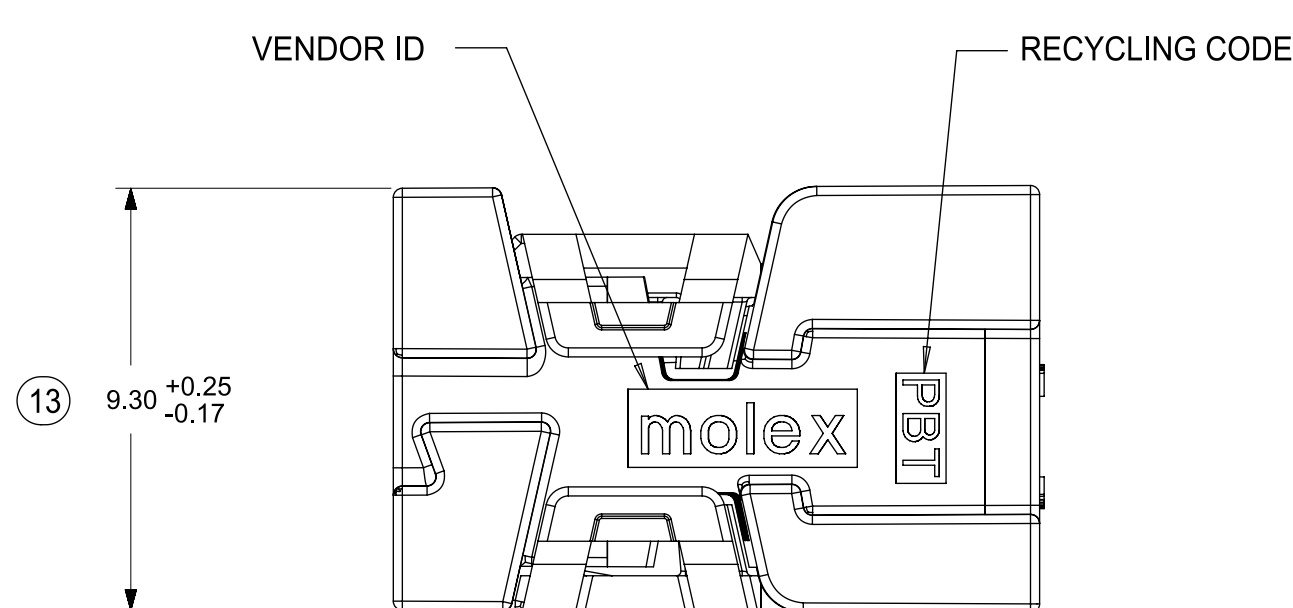

CUTAWAY SHOWING MAXIMUM POINTS ASSEMBLE HINGES

<b>QUALITY SYMBOLS</b> A = 0 E = 0 F = 0 G = 0 H = 0 I = 0 J = 0 K = 0 L = 0 M = 0 N = 0 O = 0 P = 0 Q = 0 R = 0 S = 0 T = 0 U = 0 V = 0 W = 0 X = 0 Y = 0 Z = 0	THIS DRAWING CONTAINS INFORMATION THAT IS PROPRIETARY TO MOLEX ELECTRONIC TECHNOLOGIES, LLC AND SHOULD NOT BE USED WITHOUT WRITTEN PERMISSION			
	2019/03/27	2019/03/29	2019/03/29	GENERAL TOLERANCES (UNLESS SPECIFIED)
	DIMENSION UNITS		SCALE	
	MM ONLY		6:1	
	DRWN BY		DATE	
	TCUCU		2011/03/10	
	CHK'D BY		DATE	
	TMACHUGA		2011/03/11	
	APPR BY		DATE	
	SMARCEAU		2012/05/21	
DRAWING SIZE		THIRD ANGLE PROJECTION		
E				
EC NO: 614746	DRWN: SRUSS	CHKD: JDUNAJ	APPR: JDUNAJ	
L5				
SERIES		MATERIAL NUMBER		
34824		SEE TABLE		
CUSTOMER		GENERAL MARKET		
DOCUMENT NUMBER		DOC TYPE		
SD-34824-002		PSD		
DOC PART		SHEET NUMBER		
001		3 OF 4		

# molex®

## MINI50 DUAL ROW RECEPTACLE SALES DRAWING

### PRODUCT CUSTOMER DRAWING

MINI50 RECEPTACLE ASSEMBLIES

PBT RECEPTACLES

MATERIAL NUMBER BULK PACKAGING PK-31301-538	LOCK BRIDGE OPTION	CONFIGURATION	CIRCUIT	POL	COLOR	MATING COMPONENT					
						SURFACE MOUNT TECHNOLOGY (SMT) HEADER		VERTICAL THRU HOLE HEADER		RIGHT ANGLE THRU HOLE HEADER	
						TAPE AND REEL PACKAGING PK-31301-786	TUBE PACKAGING PK-31301-688	TRAY PACKAGING PK-31301-440	TUBE PACKAGING PK-31301-688	TRAY PACKAGING PK-31301-440	TUBE PACKAGING PK-31301-688
34824-0124	NO	USCAR COMPATIBLE	12	A	BLACK	34897-8120	34897-9120	34825-0124	34825-9124	34826-0124	34826-9124
34824-0125	NO	USCAR COMPATIBLE	12	B	GRAY	34897-8121	34897-9121	34825-0125	34825-9125	34826-0125	34826-9125
34824-0126	NO	USCAR COMPATIBLE	12	C	DARK GRAY	34897-8122	34897-9122	34825-0126	34825-9126	34826-0126	34826-9126
34824-1124	YES	USCAR COMPATIBLE	12	A	BLACK	34897-8120	34897-9120	34825-0124	34825-9124	34826-0124	34826-9124
34824-1125	YES	USCAR COMPATIBLE	12	B	GRAY	34897-8121	34897-9121	34825-0125	34825-9125	34826-0125	34826-9125
34824-1126	YES	USCAR COMPATIBLE	12	C	DARK GRAY	34897-8122	34897-9122	34825-0126	34825-9126	34826-0126	34826-9126
34824-0160	NO	USCAR COMPATIBLE	16	A	BLACK	34897-8160	34897-9160	34825-0160	34825-9160	34826-0160	34826-9160
34824-0161	NO	USCAR COMPATIBLE	16	B	GRAY	34897-8161	34897-9161	34825-0161	34825-9161	34826-0161	34826-9161
34824-0162	NO	USCAR COMPATIBLE	16	C	DARK GRAY	34897-8162	34897-9162	34825-0162	34825-9162	34826-0162	34826-9162
34824-1160	YES	USCAR COMPATIBLE	16	A	BLACK	34897-8160	34897-9160	34825-0160	34825-9160	34826-0160	34826-9160
34824-1161	YES	USCAR COMPATIBLE	16	B	GRAY	34897-8161	34897-9161	34825-0161	34825-9161	34826-0161	34826-9161
34824-1162	YES	USCAR COMPATIBLE	16	C	DARK GRAY	34897-8162	34897-9162	34825-0162	34825-9162	34826-0162	34826-9162
34824-0200	NO	USCAR COMPATIBLE	20	A	BLACK	34897-8200	34897-9200	34825-0200	34825-9200	34826-0200	34826-9200
34824-0201	NO	USCAR COMPATIBLE	20	B	GRAY	34897-8201	34897-9201	34825-0201	34825-9201	34826-0201	34826-9201
34824-0202	NO	USCAR COMPATIBLE	20	C	DARK GRAY	34897-8202	34897-9202	34825-0202	34825-9202	34826-0202	34826-9202
34824-1200	YES	USCAR COMPATIBLE	20	A	BLACK	34897-8200	34897-9200	34825-0200	34825-9200	34826-0200	34826-9200
34824-1201	YES	USCAR COMPATIBLE	20	B	GRAY	34897-8201	34897-9201	34825-0201	34825-9201	34826-0201	34826-9201
34824-1202	YES	USCAR COMPATIBLE	20	C	DARK GRAY	34897-8202	34897-9202	34825-0202	34825-9202	34826-0202	34826-9202
34824-0240	NO	USCAR COMPATIBLE	24	A	BLACK	34897-8240	34897-9240	34825-0240	34825-9240	34826-0240	34826-9240
34824-0241	NO	USCAR COMPATIBLE	24	B	GRAY	34897-8241	34897-9241	34825-0241	34825-9241	34826-0241	34826-9241
34824-0242	NO	USCAR COMPATIBLE	24	C	DARK GRAY	34897-8242	34897-9242	34825-0242	34825-9242	34826-0242	34826-9242
34824-1240	YES	USCAR COMPATIBLE	24	A	BLACK	34897-8240	34897-9240	34825-0240	34825-9240	34826-0240	34826-9240
34824-1241	YES	USCAR COMPATIBLE	24	B	GRAY	34897-8241	34897-9241	34825-0241	34825-9241	34826-0241	34826-9241
34824-1242	YES	USCAR COMPATIBLE	24	C	DARK GRAY	34897-8242	34897-9242	34825-0242	34825-9242	34826-0242	34826-9242

ECOPAXX RECEPTACLES

MATERIAL NUMBER BULK PACKAGING PK-31301-538	LOCK BRIDGE OPTION	CONFIGURATION	CIRCUIT	POL	COLOR	MATING COMPONENT					
						SURFACE MOUNT TECHNOLOGY (SMT) HEADER		VERTICAL THRU HOLE HEADER		RIGHT ANGLE THRU HOLE HEADER	
						TAPE AND REEL PACKAGING PK-31301-786	TUBE PACKAGING PK-31301-688	TRAY PACKAGING PK-31301-440	TUBE PACKAGING PK-31301-688	TRAY PACKAGING PK-31301-440	TUBE PACKAGING PK-31301-688
34824-0164	NO	USCAR COMPATIBLE	16	A	BLACK	34897-8160	34897-9160	34825-0160	34825-9160	34826-0160	34826-9160
34824-0165	NO	USCAR COMPATIBLE	16	B	GRAY	34897-8161	34897-9161	34825-0161	34825-9161	34826-0161	34826-9161
34824-0166	NO	USCAR COMPATIBLE	16	C	DARK GRAY	34897-8162	34897-9162	34825-0162	34825-9162	34826-0162	34826-9162
34824-1164	YES	USCAR COMPATIBLE	16	A	BLACK	34897-8160	34897-9160	34825-0160	34825-9160	34826-0160	34826-9160
34824-1165	YES	USCAR COMPATIBLE	16	B	GRAY	34897-8161	34897-9161	34825-0161	34825-9161	34826-0161	34826-9161
34824-1166	YES	USCAR COMPATIBLE	16	C	DARK GRAY	34897-8162	34897-9162	34825-0162	34825-9162	34826-0162	34826-9162
34824-0204	NO	USCAR COMPATIBLE	20	A	BLACK	34897-8200	34897-9200	34825-0200	34825-9200	34826-0200	34826-9200
34824-0205	NO	USCAR COMPATIBLE	20	B	GRAY	34897-8201	34897-9201	34825-0201	34825-9201	34826-0201	34826-9201
34824-0206	NO	USCAR COMPATIBLE	20	C	DARK GRAY	34897-8202	34897-9202	34825-0202	34825-9202	34826-0202	34826-9202
34824-1204	YES	USCAR COMPATIBLE	20	A	BLACK	34897-8200	34897-9200	34825-0200	34825-9200	34826-0200	34826-9200
34824-1205	YES	USCAR COMPATIBLE	20	B	GRAY	34897-8201	34897-9201	34825-0201	34825-9201	34826-0201	34826-9201
34824-1206	YES	USCAR COMPATIBLE	20	C	DARK GRAY	34897-8202	34897-9202	34825-0202	34825-9202	34826-0202	34826-9202
34824-0244	NO	USCAR COMPATIBLE	24	A	BLACK	34897-8240	34897-9240	34825-0240	34825-9240	34826-0240	34826-9240
34824-0245	NO	USCAR COMPATIBLE	24	B	GRAY	34897-8241	34897-9241	34825-0241	34825-9241	34826-0241	34826-9241
34824-0246	NO	USCAR COMPATIBLE	24	C	DARK GRAY	34897-8242	34897-9242	34825-0242	34825-9242	34826-0242	34826-9242
34824-1244	YES	USCAR COMPATIBLE	24	A	BLACK	34897-8240	34897-9240	34825-0240	34825-9240	34826-0240	34826-9240
34824-1245	YES	USCAR COMPATIBLE	24	B	GRAY	34897-8241	34897-9241	34825-0241	34825-9241	34826-0241	34826-9241
34824-1246	YES	USCAR COMPATIBLE	24	C	DARK GRAY	34897-8242	34897-9242	34825-0242	34825-9242	34826-0242	34826-9242

CTX50 UNSEALED RECEPTACLE TERMINALS

PART NUMBER		MATERIAL	WIRE GAGE (mm <sup>2</sup> )	GRIP
D-WIND (LEFT PAYOFF)	B-WIND (RIGHT PAYOFF)			
560023-0448	560023-0450	COPPER ALLOY	0.35	LARGE
560023-0421	560023-0423	COPPER ALLOY	0.22	MEDIUM
560023-0422	560023-0424	COPPER ALLOY	0.13	SMALL

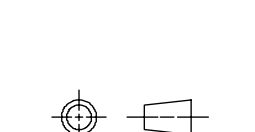
QUALITY SYMBOLS A = 0 E = 0 E = 0 E = 0 E = 0 E = 0 E = 0 E = 0 E = 0 E = 0 E = 0 E = 0	THIS DRAWING CONTAINS INFORMATION THAT IS PROPRIETARY TO MOLEX ELECTRONIC TECHNOLOGIES, LLC AND SHOULD NOT BE USED WITHOUT WRITTEN PERMISSION												
	2019/03/27 DRWN: SRUSS 2019/03/29 CHKD: JDUNAJ 2019/03/29 REV APPR: JDUNAJ	GENERAL TOLERANCES (UNLESS SPECIFIED)			DIMENSION UNITS		SCALE		  MINI50 DUAL ROW RECEPTACLE SALES DRAWING  PRODUCT CUSTOMER DRAWING  SERIES: 34824 MATERIAL NUMBER: SEE TABLE CUSTOMER: GENERAL MARKET  DOCUMENT NUMBER: SD-34824-002 DOC TYPE: PSD DOC PART: 001 SHEET NUMBER: 4 OF 4				
		MM ONLY			1:1								
	DRWN BY		DATE		TCUCU		2011/03/10						
	CHK'D BY		DATE		TMACHUGA		2011/03/11						
	APPR BY		DATE		SMARCEAU		2012/05/21						
	DRAWING SIZE		THIRD ANGLE PROJECTION		E								
	DRAFT WHERE APPLICABLE MUST REMAIN WITHIN DIMENSIONS												
	L5												