

MSKSEMI

SEMICONDUCTOR



ESD



TVS



TSS



MOV



GDT



PLED

Product data sheet

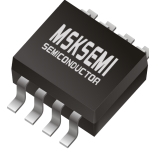

SOP-8

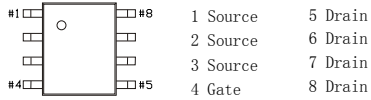

■ Features

- $V_{DS} (V) = -30V$
- $I_D = -15 A (V_{GS} = -10V)$
- $R_{DS(ON)} < 7.5m\Omega (V_{GS} = -10V)$
- $R_{DS(ON)} < 12m\Omega (V_{GS} = -4.5V)$

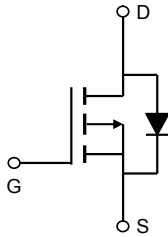

Absolute Maximum Ratings $T_a = 25^\circ C$

Parameter	Symbol	Rating	Unit	
Drain-Source Voltage	V_{DS}	-30	V	
Gate-Source Voltage	V_{GS}	± 20		
Continuous Drain Current	I_D	$T_A = 25^\circ C$	-15	A
		$T_A = 70^\circ C$	-12.8	
Pulsed Drain Current	I_{DM}	-80		
Avalanche Current	I_{AS}, I_{AR}	30		
Avalanche energy	$L = 0.1mH$	E_{AS}, E_{AR}	135	mJ
Power Dissipation	P_D	$T_A = 25^\circ C$	3.1	W
		$T_A = 70^\circ C$	2	
Thermal Resistance.Junction- to-Ambient	R_{thJA}	$t \leq 10s$	40	$^\circ C/W$
		Steady-State	75	
Thermal Resistance.Junction- to-Lead	R_{thJL}	24		
Junction Temperature	T_J	150	$^\circ C$	
Junction Storage Temperature Range	T_{stg}	-55 to 150		

Electrical Characteristics Ta = 25°C

Parameter	Symbol	Test Conditions	Min	Typ	Max	Unit	
Drain-Source Breakdown Voltage	V _{DSS}	I _D =-250 μ A, V _{GS} =0V	-30			V	
Zero Gate Voltage Drain Current	I _{DSS}	V _{DS} =-30V, V _{GS} =0V			-5	μA	
		V _{DS} =-30V, V _{GS} =0V, T _J =55°C			-25		
Gate-Body leakage current	I _{GSS}	V _{DS} =0V, V _{GS} =±20V			±100	nA	
Gate Threshold Voltage	V _{GS(th)}	V _{DS} =V _{GS} I _D =-250 μ A	-1.4		-2.7	V	
Static Drain-Source On-Resistance	R _{DS(on)}	V _{GS} =-10V, I _D =-15A			7.5	mΩ	
		V _{GS} =-10V, I _D =-15A T _J =125°C			11.5		
		V _{GS} =-4.5V, I _D =-10A			12		
On state drain current	I _{D(ON)}	V _{GS} =-10V, V _{DS} =-5V	-80			A	
Forward Transconductance	g _{FS}	V _{DS} =-5V, I _D =-15A	35	50		S	
Input Capacitance	C _{iss}	V _{GS} =0V, V _{DS} =-15V, f=1MHz		5270	6400	pF	
Output Capacitance	C _{oss}			945			
Reverse Transfer Capacitance	C _{rss}			745			
Gate resistance	R _g	V _{GS} =0V, V _{DS} =0V, f=1MHz		2	3	Ω	
Total Gate Charge (10V)	Q _g	V _{GS} =-10V, V _{DS} =-15V, I _D =-15A		100	120	nC	
Total Gate Charge (4.5V)				51.5			
Gate Source Charge			Q _{gs}		14.5		
Gate Drain Charge			Q _{gd}		23		
Turn-On DelayTime	t _{d(on)}	V _{GS} =-10V, V _{DS} =-15V, R _L =1Ω, R _{GEN} =3Ω		14		ns	
Turn-On Rise Time	t _r			16.5			
Turn-Off DelayTime	t _{d(off)}			76.5			
Turn-Off Fall Time	t _f			37.5			
Body Diode Reverse Recovery Time	t _{rr}	I _F =-15A, d _i /d _t =100A/us		36.7	45	nC	
Body Diode Reverse Recovery Charge	Q _{rr}			28			
Maximum Body-Diode Continuous Current	I _s				-5	A	
Diode Forward Voltage	V _{SD}	I _s =-1A, V _{GS} =0V			-1	V	

Note : The static characteristics in Figures 1 to 6 are obtained using <300 μs pulses, duty cycle 0.5% max.

Typical Characteristics

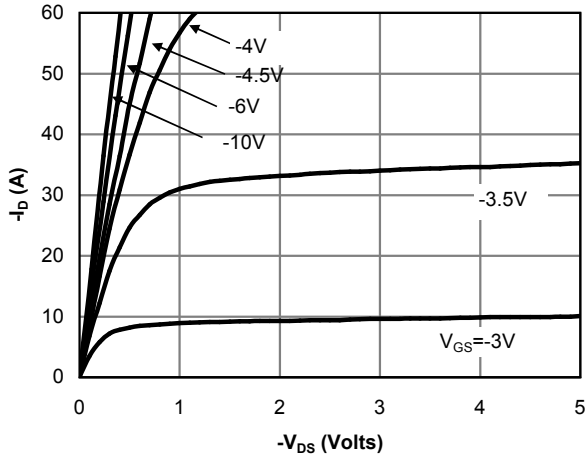

Fig 1: On-Region Characteristics (Note E)

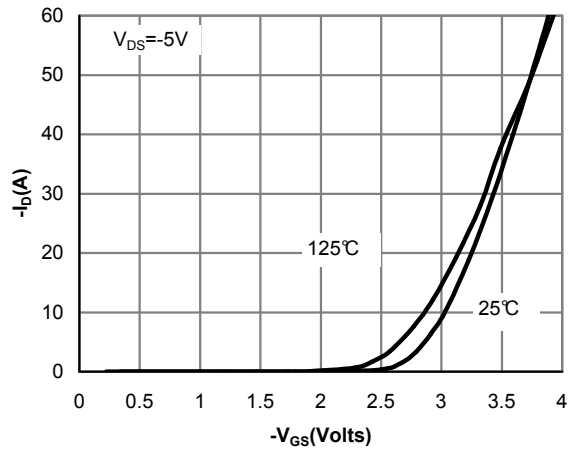

Figure 2: Transfer Characteristics (Note E)

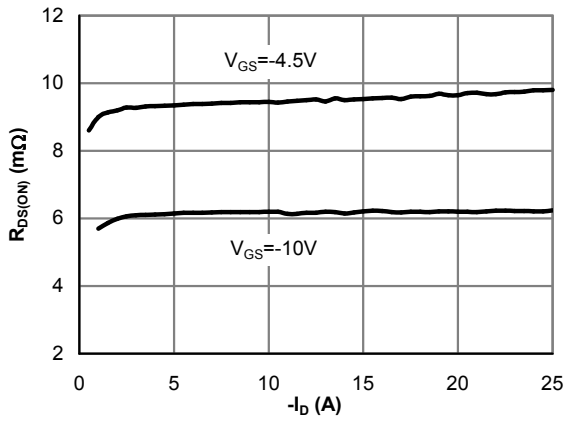

Figure 3: On-Resistance vs. Drain Current and Gate Voltage (Note E)

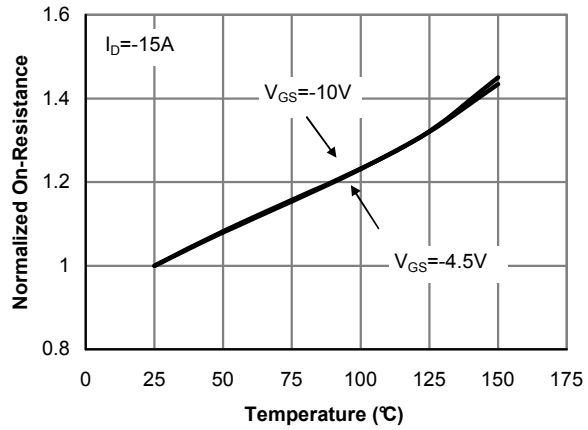

Figure 4: On-Resistance vs. Junction Temperature (Note E)

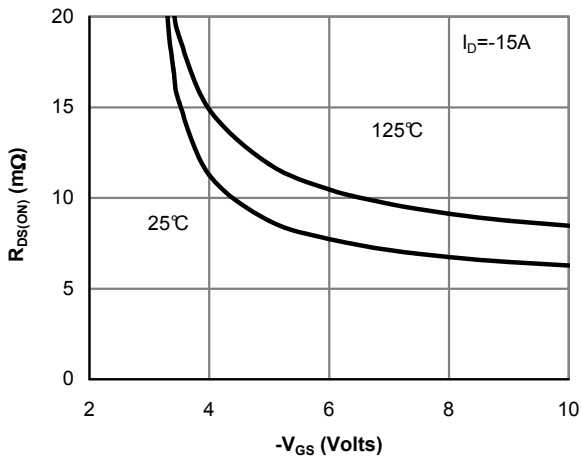

Figure 5: On-Resistance vs. Gate-Source Voltage (Note E)

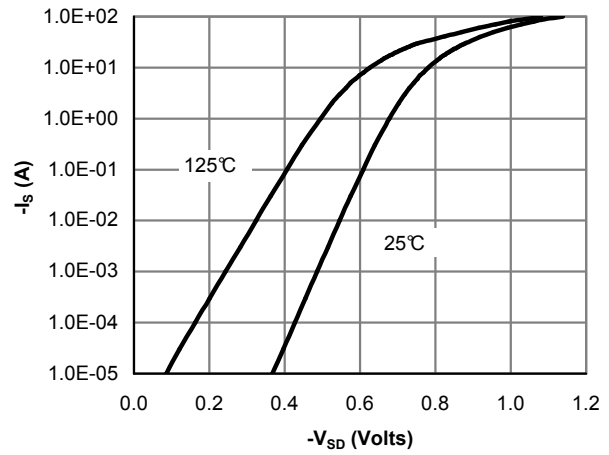

Figure 6: Body-Diode Characteristics (Note E)

Typical Characteristics

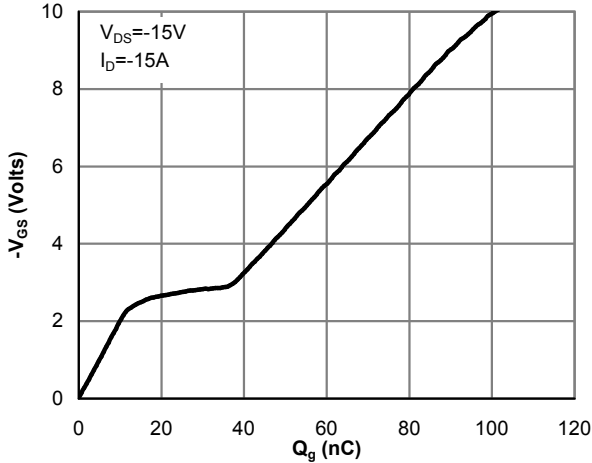

Figure 7: Gate-Charge Characteristics

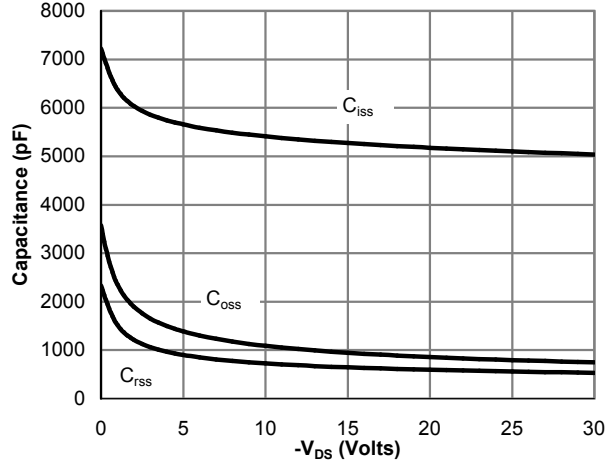

Figure 8: Capacitance Characteristics

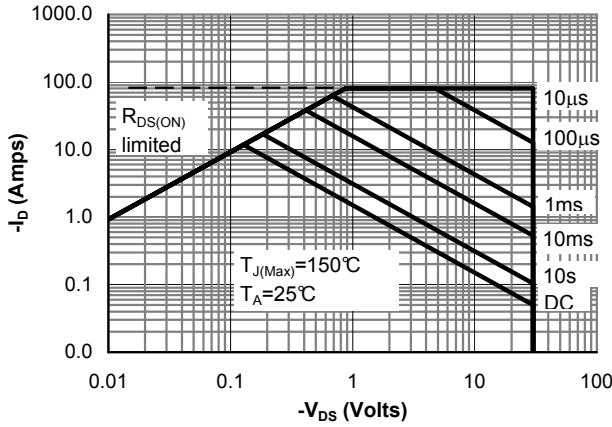

Figure 9: Maximum Forward Biased Safe Operating Area (Note F)

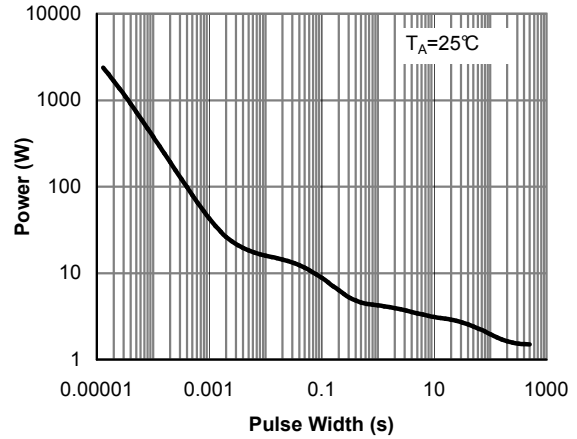

Figure 10: Single Pulse Power Rating Junction-to-Ambient (Note F)

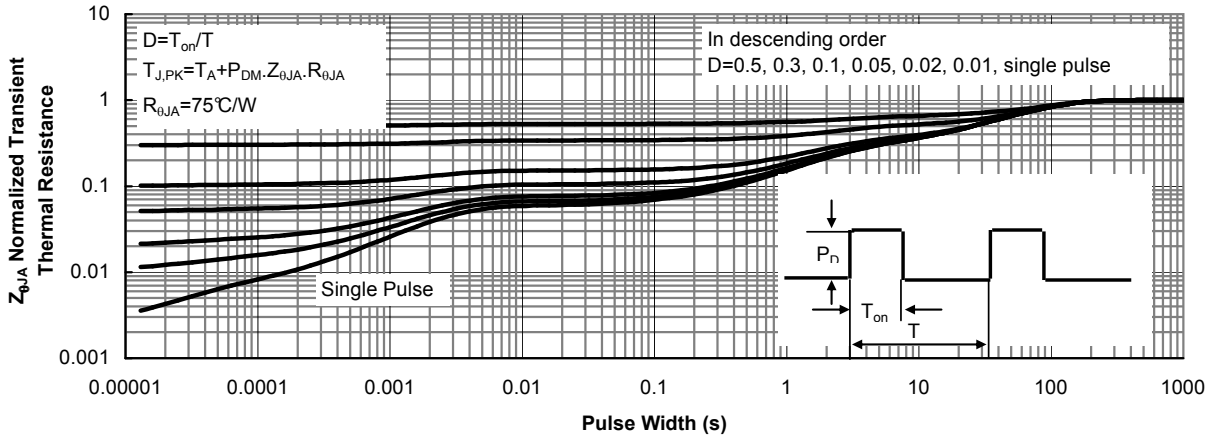
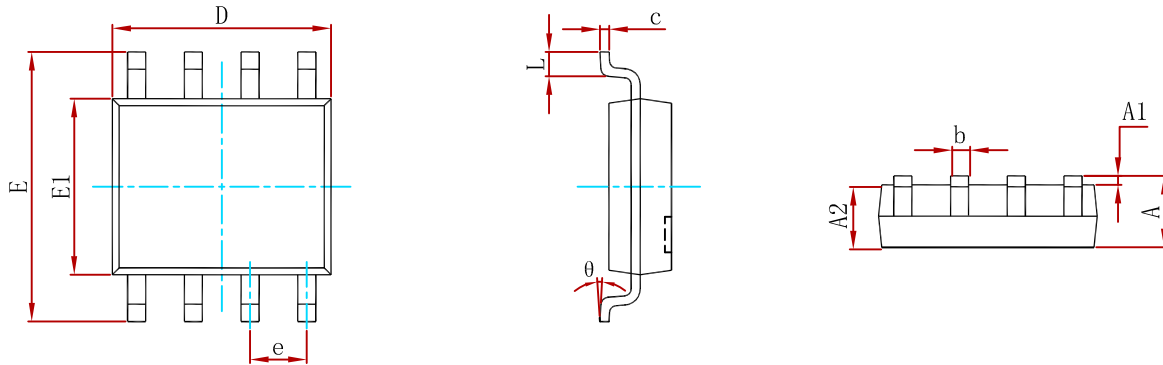

Figure 11: Normalized Maximum Transient Thermal Impedance (Note F)

PACKAGE MECHANICAL DATA



Symbol	Dimensions In Millimeters		Dimensions In Inches	
	Min	Max	Min	Max
A	1.350	1.750	0.053	0.069
A1	0.100	0.250	0.004	0.010
A2	1.350	1.550	0.053	0.061
b	0.330	0.510	0.013	0.020
c	0.170	0.250	0.007	0.010
D	4.800	5.000	0.189	0.197
e	1.270 (BSC)		0.050 (BSC)	
E	5.800	6.200	0.228	0.244
E1	3.800	4.000	0.150	0.157
L	0.400	1.270	0.016	0.050
θ	0°	8°	0°	8°

Suggested Pad Layout

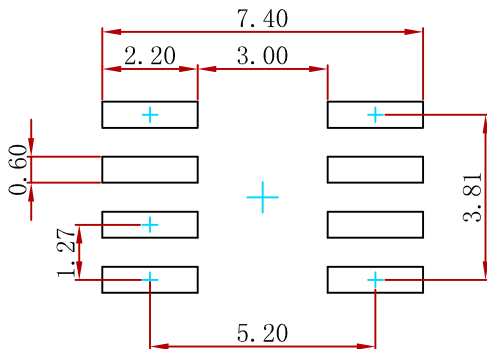

Note:
 1. Controlling dimension: in millimeters.
 2. General tolerance: ± 0.05mm.
 3. The pad layout is for reference purposes only.

REEL SPECIFICATION

P/N	PKG	QTY
AO4409-MS	SOP-8	3000

Attention

- Any and all MSKSEMI Semiconductor products described or contained herein do not have specifications that can handle applications that require extremely high levels of reliability, such as life-support systems, aircraft's control systems, or other applications whose failure can be reasonably expected to result in serious physical and/or material damage. Consult with your MSKSEMI Semiconductor representative nearest you before using any MSKSEMI Semiconductor products described or contained herein in such applications.
- MSKSEMI Semiconductor assumes no responsibility for equipment failures that result from using products at values that exceed, even momentarily, rated values (such as maximum ratings, operating condition ranges, or other parameters) listed in products specifications of any and all MSKSEMI Semiconductor products described or contained herein.
- Specifications of any and all MSKSEMI Semiconductor products described or contained herein stipulate the performance, characteristics, and functions of the described products in the independent state, and are not guarantees of the performance, characteristics, and functions of the described products as mounted in the customer's products or equipment. To verify symptoms and states that cannot be evaluated in an independent device, the customer should always evaluate and test devices mounted in the customer's products or equipment.
- MSKSEMI Semiconductor strives to supply high-quality high-reliability products. However, any and all semiconductor products fail with some probability. It is possible that these probabilistic failures could give rise to accidents or events that could endanger human lives, that could give rise to smoke or fire, or that could cause damage to other property. When designing equipment, adopt safety measures so that these kinds of accidents or events cannot occur. Such measures include but are not limited to protective circuits and error prevention circuits for safe design, redundant design, and structural design.
- In the event that any or all MSKSEMI Semiconductor products (including technical data, services) described or contained herein are controlled under any of applicable local export control laws and regulations, such products must not be exported without obtaining the export license from the authorities concerned in accordance with the above law.
- No part of this publication may be reproduced or transmitted in any form or by any means, electronic or mechanical, including photocopying and recording, or any information storage or retrieval system, or otherwise, without the prior written permission of MSKSEMI Semiconductor.
- Information (including circuit diagrams and circuit parameters) herein is for example only ; it is not guaranteed for volume production. MSKSEMI Semiconductor believes information herein is accurate and reliable, but no guarantees are made or implied regarding its use or any infringement of intellectual property rights or other rights of third parties.
- Any and all information described or contained herein are subject to change without notice due to product/technology improvement, etc. When designing equipment, refer to the "Delivery Specification" for the MSKSEMI Semiconductor product that you intend to use.