

FEATURES

Wide input bandwidth: 1 to 23 GHz
Wide dynamic range: 50 dB up to 23 GHz
Single positive supply: 3.3 V
Excellent stability over temperature
Fast rise/fall time: 12 ns/65 ns
16-lead 3 mm × 3 mm SMT package: 9 mm²

APPLICATIONS

Point-to-point microwave radio
VSAT
Wideband power monitoring
Receiver signal strength indication (RSSI)
Test and measurement

GENERAL DESCRIPTION

The **HMC1094** logarithmic detector converts RF signals at its input to a proportional dc voltage at its output. The **HMC1094** employs successive compression topology that delivers high dynamic range over a wide input frequency range.

As the input power is increased, successive amplifiers move into saturation one by one, creating an approximation of the logarithm function. The output of a series of detectors is summed, con-

verted into the voltage domain, and buffered to drive the LOGOUT output.

The **HMC1094** provides a nominal logarithmic slope of 18 mV/dB and an intercept of -113 dBm at 23 GHz. Ideal as a log detector for high volume microwave radio and VSAT applications, the **HMC1094** is housed in a compact 3 mm × 3 mm RoHS compliant SMT plastic package.

FUNCTIONAL BLOCK DIAGRAM

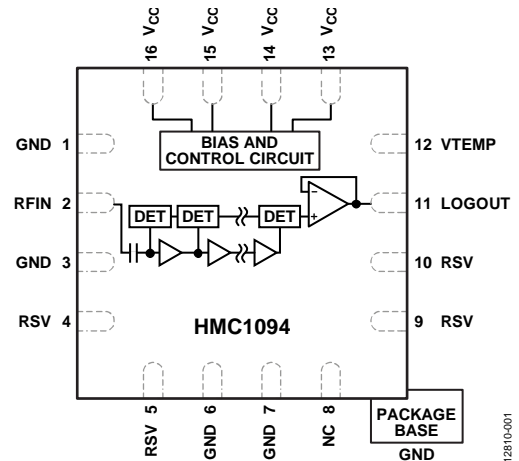

Figure 1.

12810-001

TABLE OF CONTENTS

Features	1	Interface Schematics.....	7
Applications.....	1	Typical Performance Characteristics	8
Functional Block Diagram	1	Application and Evaluation Printed Circuit Board (PCB)	
General Description	1	Schematic.....	11
Revision History	2	Evaluation PCB.....	12
Specifications.....	3	Bill of Materials for Evaluation PCB.....	12
Absolute Maximum Ratings	5	Packaging and Ordering Information	13
ESD Caution.....	5	Outline Dimensions.....	13
Pin Configuration and Function Descriptions.....	6	Ordering Guide	14

REVISION HISTORY

11/14—Rev. 00.0813 to Rev. A

This Hittite Microwave Products data sheet has been reformatted to meet the styles and standards of Analog Devices, Inc.

Updated Format.....	Universal
Changes to Ordering Guide	14

SPECIFICATIONS

$V_{CC} = 3.3\text{ V}$, $T_A = 25^\circ\text{C}$, unless otherwise noted.

Table 1.

Parameter	Test Conditions/Comments	Min	Typ	Max	Unit
OVERALL FUNCTION					
Input Frequency Range ¹		1		23	GHz
RF INPUT INTERFACE	$P_{IN} = \text{RFIN}$				
Nominal Input Impedance			50		Ω
OUTPUT INTERFACE					
Output Voltage Range		1		2.1	V
Rise Time	$f = 10\text{ GHz}$, $P_{IN} = \text{off to } 0\text{ dBm}$, 10% to 90%		12		ns
Fall Time	$f = 10\text{ GHz}$, $P_{IN} = \text{off to } 0\text{ dBm}$, 10% to 90%		65		ns
$f_{IN} = 1\text{ GHz}$					
±3 dB Dynamic Range			48		dB
±3 dB Dynamic Range Center			-20		dBm
Deviation vs. Temperature	Deviation from calculated ideal output at 25°C , $-40^\circ\text{C} < T_A < +85^\circ\text{C}$		±0.8		dB
Logarithmic Slope	Calibration at -38 dBm and -2 dBm		20		mV/dB
Logarithmic Intercept	Calibration at -38 dBm and -2 dBm (x-intercept)		-96		dBm
$f_{IN} = 5\text{ GHz}$					
±3 dB Dynamic Range			48		dB
±3 dB Dynamic Range Center			-22		dBm
Deviation vs. Temperature	Deviation from calculated ideal output at 25°C , $-40^\circ\text{C} < T_A < +85^\circ\text{C}$		±0.7		dB
Logarithmic Slope	Calibration at -38 dBm and -2 dBm		21		mV/dB
Logarithmic Intercept	Calibration at -38 dBm and -2 dBm (x-intercept)		-97		dBm
$f_{IN} = 10\text{ GHz}$					
±3 dB Dynamic Range			48		dB
±3 dB Dynamic Range Center			-23		dBm
Deviation vs. Temperature	Deviation from calculated ideal output at 25°C , $-40^\circ\text{C} < T_A < +85^\circ\text{C}$		±0.5		dB
Logarithmic Slope	Calibration at -38 dBm and -2 dBm		20		mV/dB
Logarithmic Intercept	Calibration at -38 dBm and -2 dBm (x-intercept)		-100		dBm
$f_{IN} = 14\text{ GHz}$					
±3 dB Dynamic Range			50		dB
±3 dB Dynamic Range Center			-24		dBm
Deviation vs. Temperature	Deviation from calculated ideal output at 25°C , $-40^\circ\text{C} < T_A < +85^\circ\text{C}$		±1		dB
Logarithmic Slope	Calibration at -38 dBm and -2 dBm		19		mV/dB
Logarithmic Intercept	Calibration at -38 dBm and -2 dBm (x-intercept)		-105		dBm
$f_{IN} = 16\text{ GHz}$					
±3 dB Dynamic Range			54		dB
±3 dB Dynamic Range Center			-25		dBm
Deviation vs. Temperature	Deviation from calculated ideal output at 25°C , $-40^\circ\text{C} < T_A < +85^\circ\text{C}$		±0.7		dB
Logarithmic Slope	Calibration at -38 dBm and -2 dBm		19		mV/dB
Logarithmic Intercept	Calibration at -38 dBm and -2 dBm (x-intercept)		-108		dBm

Parameter	Test Conditions/Comments	Min	Typ	Max	Unit
$f_{IN} = 18$ GHz					
±3 dB Dynamic Range			54		dB
±3 dB Dynamic Range Center			-26		dBm
Deviation vs. Temperature	Deviation from calculated ideal output at 25°C, -40°C < T _A < +85°C		±0.7		dB
Logarithmic Slope	Calibration at -38 dBm and -2 dBm		18		mV/dB
Logarithmic Intercept	Calibration at -38 dBm and -2 dBm (x-intercept)		-111		dBm
$f_{IN} = 20$ GHz					
±3 dB Dynamic Range			55		dB
±3 dB Dynamic Range Center			-27		dBm
Deviation vs. Temperature	Deviation from calculated ideal output at 25°C, -40°C < T _A < +85°C		±0.8		dB
Logarithmic Slope	Calibration at -38 dBm and -2 dBm		18		mV/dB
Logarithmic Intercept	Calibration at -38 dBm and -2 dBm (x-intercept)		-113		dBm
$f_{IN} = 23$ GHz					
±3 dB Dynamic Range			57		dB
±3 dB Dynamic Range Center			-24		dBm
Deviation vs. Temperature	Deviation from calculated ideal output at 25°C, -40°C < T _A < +85°C		±1.1		dB
Logarithmic Slope	Calibration at -38 dBm and -2 dBm		18		mV/dB
Logarithmic Intercept	Calibration at -38 dBm and -2 dBm (x-intercept)		-113		dBm
POWER SUPPLY INTERFACE					
Supply Voltage		3.15	3.30	3.45	V
Supply Current		70	85	95	mA

¹ Video output load should be 1 kΩ or higher.

ABSOLUTE MAXIMUM RATINGS

Table 2.

Parameter	Rating
Supply Voltage, V_{CC}	3.6 V
RF Input Power, RFIN	13 dBm
RF DC Level	1.1 V
Maximum Junction Temperature (T_J)	125°C
Continuous Power Dissipation (P_{DISS}) at $T_A = 85^\circ\text{C}$ (Derate 65.4 mW/°C Above 85°C)	2.62 W
Thermal Resistance (R_{TH}) (Junction to Ground Paddle)	15.29°C/W
Storage Temperature	-65°C to +150°C
Operating Temperature	-40°C to +85°C
ESD Sensitivity Level (HBM)	Class 1B

Stresses at or above those listed under Absolute Maximum Ratings may cause permanent damage to the product. This is a stress rating only; functional operation of the product at these or any other conditions above those indicated in the operational section of this specification is not implied. Operation beyond the maximum operating conditions for extended periods may affect product reliability.

ESD CAUTION

ESD (electrostatic discharge) sensitive device. Charged devices and circuit boards can discharge without detection. Although this product features patented or proprietary protection circuitry, damage may occur on devices subjected to high energy ESD. Therefore, proper ESD precautions should be taken to avoid performance degradation or loss of functionality.

PIN CONFIGURATION AND FUNCTION DESCRIPTIONS

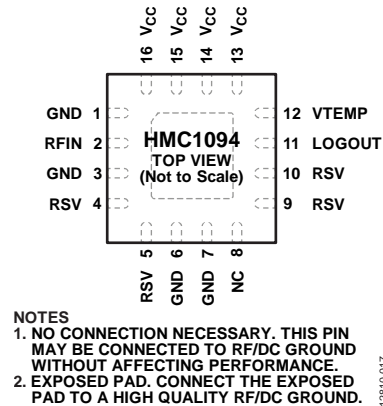

Figure 2. Pin Configuration

Table 3. Pin Function Descriptions

Pin No.	Mnemonic	Description
1	GND	Ground. This pin must be connected to a high quality RF/dc ground.
2	RFIN	RF Input. The dc voltage level of the RF input should be 0 V. If the RF input has a dc level different than 0 V, use a dc block capacitor.
3	GND	Ground. This pin must be connected to a high quality RF/dc ground.
4	RSV	Reserved. This pin is reserved for internal use; leave this pin floating.
5	RSV	Reserved. This pin is reserved for internal use; leave this pin floating.
6	GND	Ground. This pin must be connected to a high quality RF/dc ground.
7	GND	Ground. This pin must be connected to a high quality RF/dc ground.
8	NC	No Connect. No connection is necessary for this pin; this pin may be connected to RF/dc ground without affecting performance.
9	RSV	Reserved. This pin is reserved for internal use; leave this pin floating.
10	RSV	Reserved. This pin is reserved for internal use; leave this pin floating.
11	LOGOUT	Log Out. The log out load should be at least 1 k Ω or higher.
12	VTEMP	Temperature Sensor Output. This pin requires a minimum 10 k Ω resistance or higher.
13	V _{CC}	Bias Supply. Connect a supply voltage to this pin with appropriate filtering.
14	V _{CC}	Bias Supply. Connect a supply voltage to this pin with appropriate filtering.
15	V _{CC}	Bias Supply. Connect a supply voltage to this pin with appropriate filtering.
16	V _{CC}	Bias Supply. Connect a supply voltage to this pin with appropriate filtering.
	EP	Exposed Pad. Connect the exposed pad to a high quality RF/dc ground.

INTERFACE SCHEMATICS



Figure 3. GND Interface

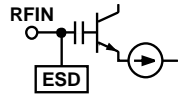

Figure 4. RFIN Interface

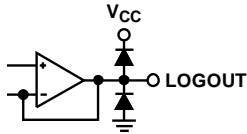

Figure 5. LOGOUT Interface

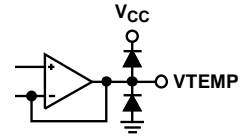

Figure 6. VTEMP Interface

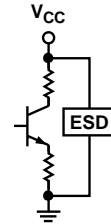

Figure 7. VCC Interface

TYPICAL PERFORMANCE CHARACTERISTICS

$V_{CC} = 3.3\text{ V}$, $T_A = 25^\circ\text{C}$, unless otherwise noted.

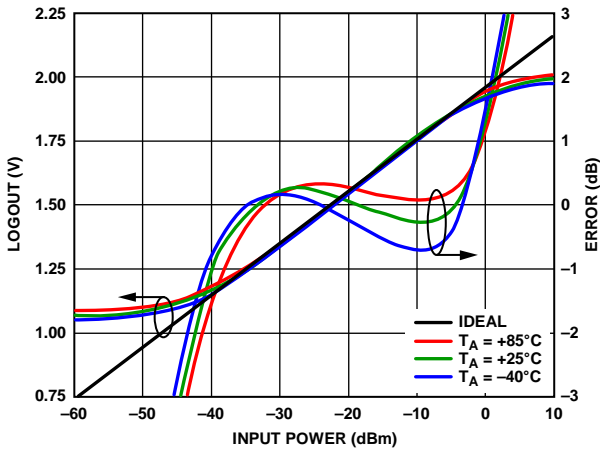

Figure 8. LOGOUT and Error vs. Input Power, $f_{IN} = 1\text{ GHz}$

12810-002

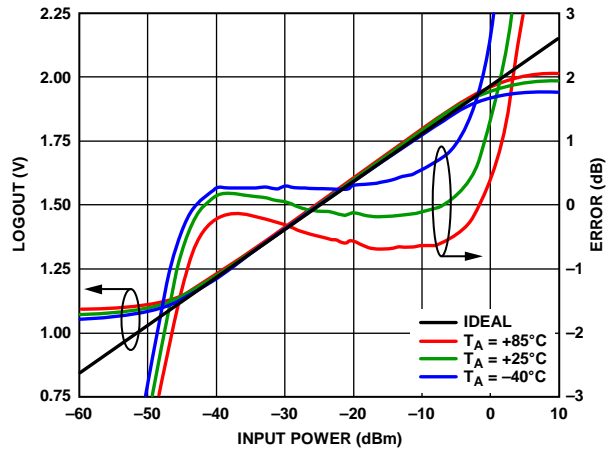

Figure 11. LOGOUT and Error vs. Input Power, $f_{IN} = 14\text{ GHz}$

12810-005

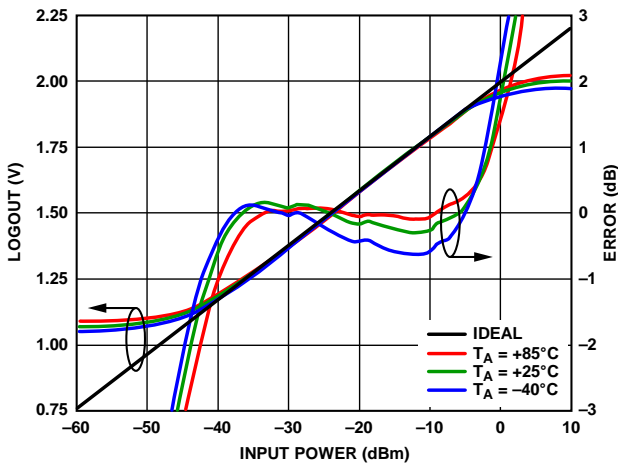

Figure 9. LOGOUT and Error vs. Input Power, $f_{IN} = 5\text{ GHz}$

12810-003

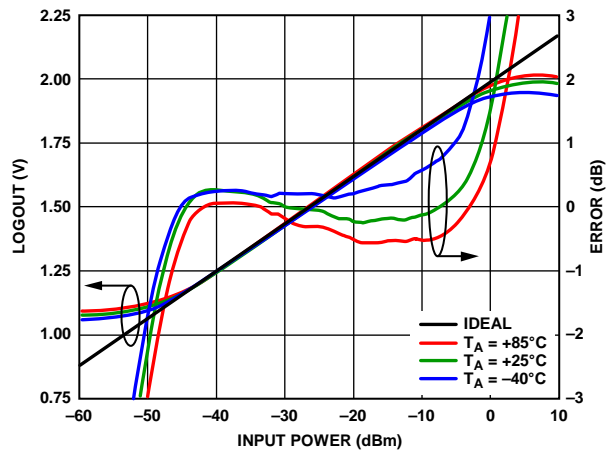

Figure 12. LOGOUT and Error vs. Input Power, $f_{IN} = 16\text{ GHz}$

12810-006

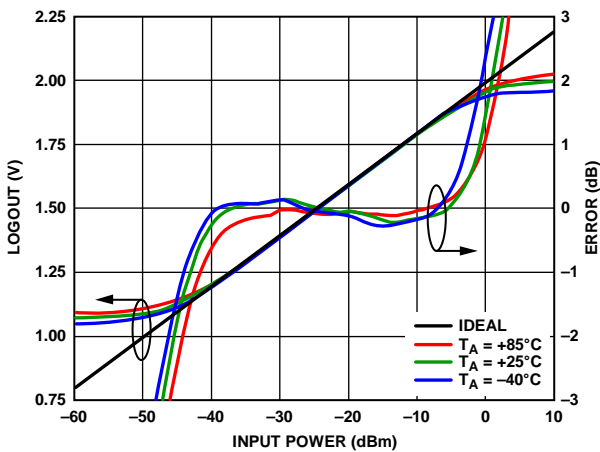

Figure 10. LOGOUT and Error vs. Input Power, $f_{IN} = 10\text{ GHz}$

12810-004

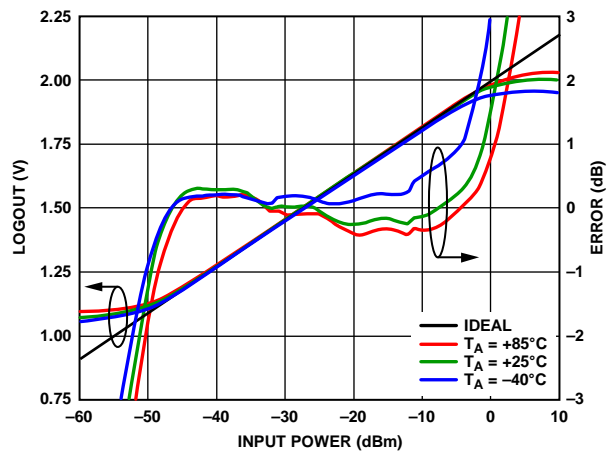

Figure 13. LOGOUT and Error vs. Input Power, $f_{IN} = 18\text{ GHz}$

12810-007

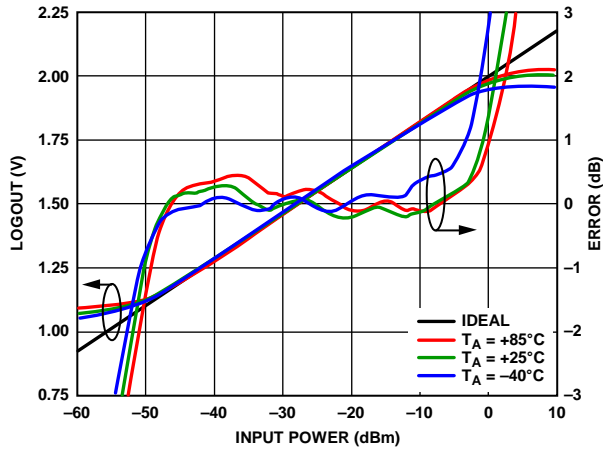

Figure 14. LOGOUT and Error vs. Input Power, $f_{IN} = 20$ GHz

12810-008

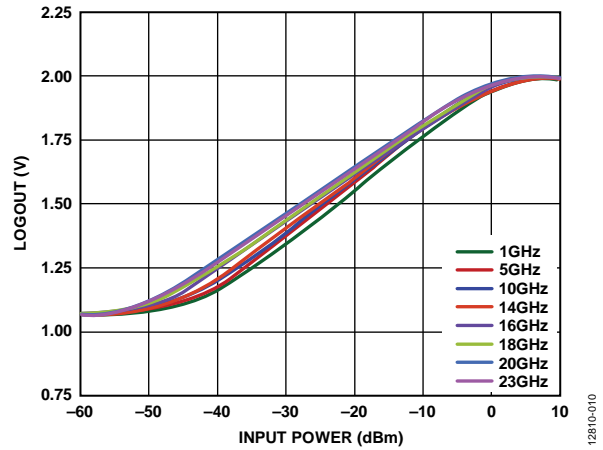

Figure 16. LOGOUT vs. Frequency

12810-010

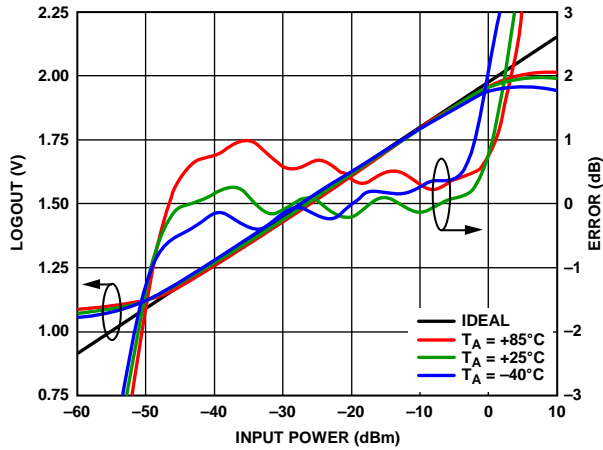

Figure 15. LOGOUT and Error vs. Input Power, $f_{IN} = 23$ GHz

12810-009

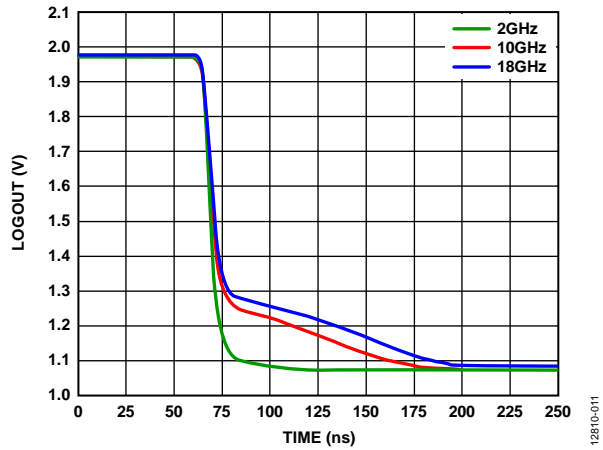

Figure 17. Fall Time for Various Frequencies at $P_{IN} = 0$ dBm

12810-011

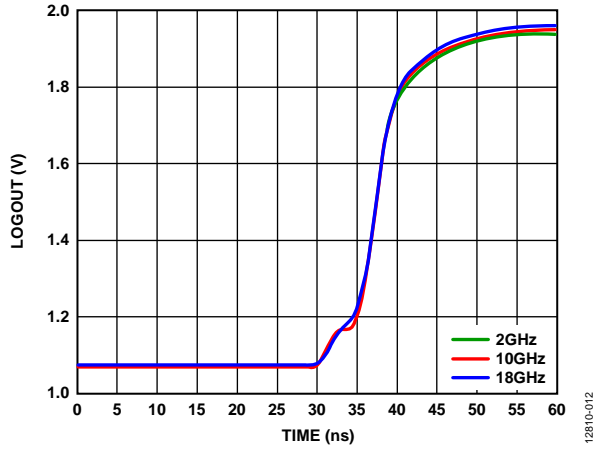

Figure 18. Rise Time for Various Frequencies at $P_{IN} = 0 \text{ dBm}$

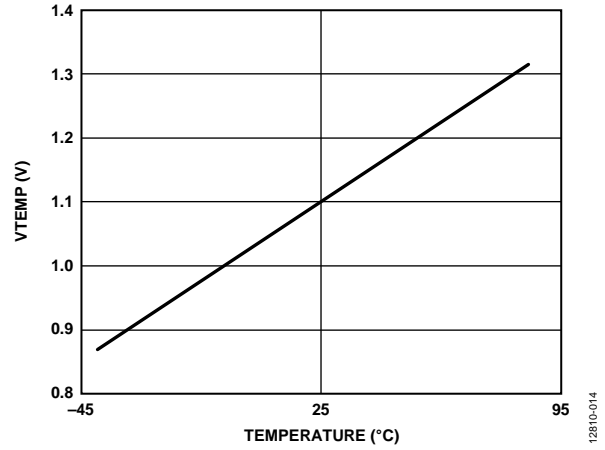

Figure 20. V_{TEMP} vs. Temperature

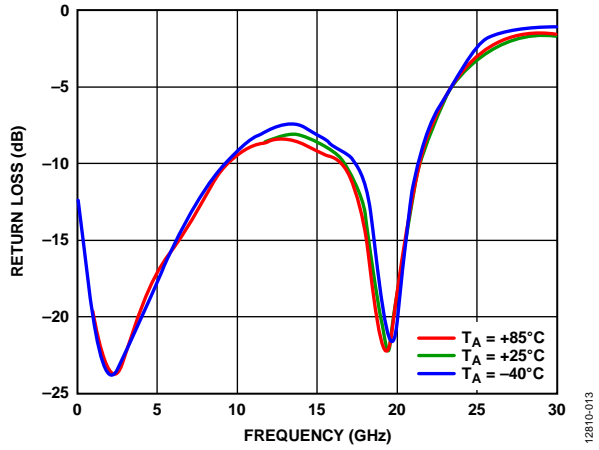

Figure 19. Input Return Loss vs. Frequency

APPLICATION AND EVALUATION PRINTED CIRCUIT BOARD (PCB) SCHEMATIC

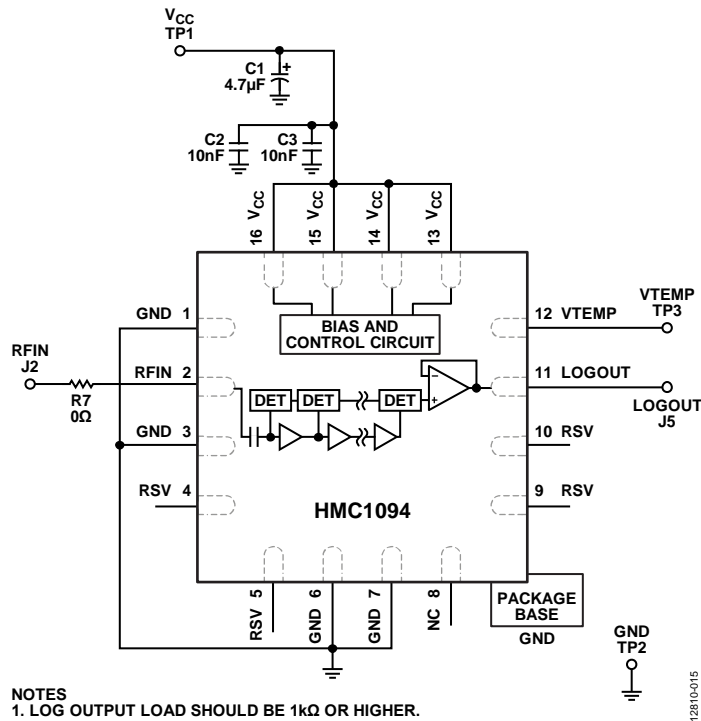

Figure 21. Application and Evaluation PCB Schematic

Table 4.

Component	Description	Default Value
R7	Bypass resistor; used to make the RFIN line connection on the board	R7 = 0 Ω (Size 0402)
C1	Power supply decoupling	C1 = 4.7 µF (size tantalum)
C2, C3	Power supply decoupling	C2 and C3 = 10 nF (Size 0402)

EVALUATION PCB

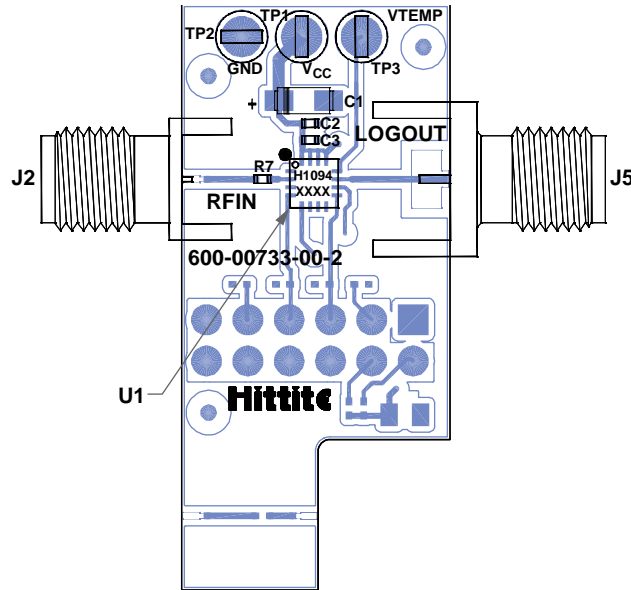

Figure 22. Evaluation PCB Layout, Top Side

12810-016

BILL OF MATERIALS FOR EVALUATION PCB

Table 5. Bill of Materials

Item	Description
J2	K-type connector
J5	SMA connector
TP1, TP2, TP3	DC pin
C2, C3	10 nF capacitor, 0402 package
C1	4.7 μ F tantalum capacitor
R7	0 Ω resistor, 0402 package
U1	HMC1094 log detector
PCB ¹	600-00733-00 evaluation PCB

¹ Circuit board material: Rogers 4350B or Arlon 25 FR.

The circuit board used in the application uses RF circuit design techniques. Signal lines should have 50 Ω impedance whereas the package ground leads and exposed paddle should be connected directly to the ground plane similar to that shown in Figure 21. Use a sufficient number of via holes to connect the top and bottom ground planes.

PACKAGING AND ORDERING INFORMATION

OUTLINE DIMENSIONS

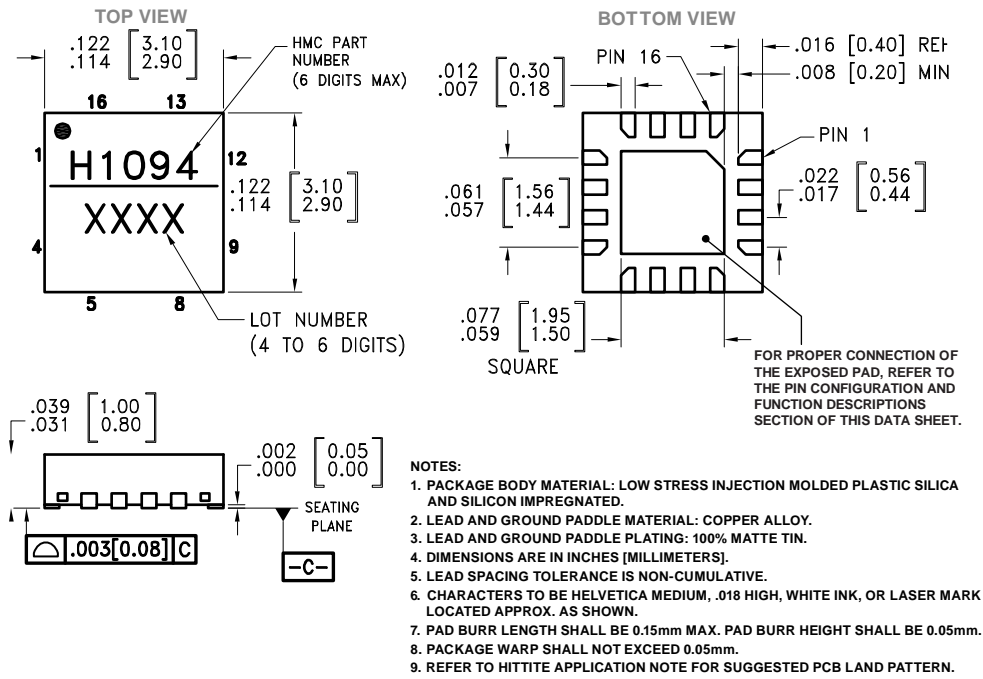
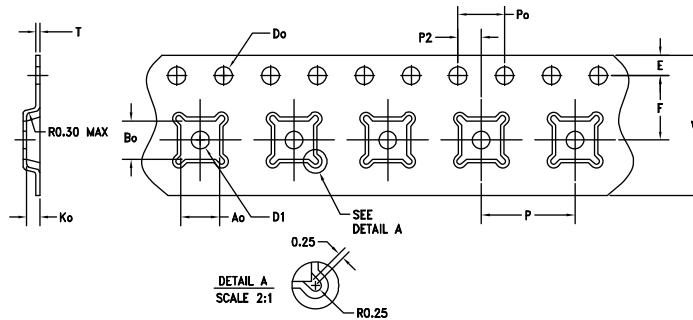

Figure 23. 16-Lead Quad Flat No-Lead Package [QFN]
 3 mm x 3 mm Body, Very Thin Quad
 Dimensions shown in inches and [millimeters]



CAVITY: LP3, LC3 & LC3B

DIMENSION	SPEC
W	12.00 +/-0.30
Do	1.5 +0.1/-0.0
Po (SEE NOTE 2)	4.00 +/-0.10
E	1.75 +/-0.10
D1	1.5 DIA MIN
Ao	3.3 +/-0.10
Bo	3.3 +/-0.10
P	8.0 +/-0.10
P2 (SEE NOTE 7)	2.0 +/-0.05
Ko	1.1 +/-0.10
T	0.30 +/-0.05
F (SEE NOTE 7)	5.5 +/-0.05

- NOTES:**
1. ALL DIMENSIONS ARE IN MILLIMETERS
 2. 10 SPROCKET HOLE PITCH CUMULATIVE TOLERANCE ±0.2
 3. CAMBER NOT TO EXCEED 1mm IN 100mm
 4. MATERIAL: CONDUCTIVE /BLACK POLYSTYRENE
 5. Ao AND Bo MEASURED ON A PLANE 0.3mm ABOVE THE BOTTOM OF THE POCKET
 6. Ko MEASURED FROM A PLANE ON THE INSIDE BOTTOM OF THE POCKET TO THE TOP SURFACE OF THE CARRIER
 7. POCKET POSITION RELATIVE TO SPROCKET HOLE MEASURED AS TRUE POSITION OF POCKET, NOT POCKET HOLE

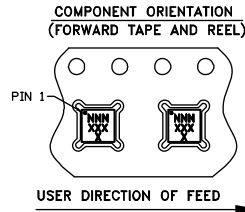

Figure 24. Tape and Reel Outline Dimensions
 Dimensions shown in millimeters

ORDERING GUIDE

Model ¹	Temperature Range	Lead Finish	MSL Rating ²	Package Description	Package Option	Qty.	Branding ³
HMC1094LP3E	-40°C to +85°C	100% matte Sn	MSL1	16-Lead Low Stress Injection Molded Plastic			<u>H1094</u> XXXX
HMC1094LP3ETR	-40°C to +85°C	100% matte Sn	MSL1	16-Lead Low Stress Injection Molded Plastic, 7" Tape and Reel	QFN	500	<u>H1094</u> XXXX
EV1HMC1094LP3				HMC1094 Evaluation Board			

¹ E = RoHS Compliant Part.

² Maximum peak reflow temperature of 260°C for HMC1094LP3E and HMC1094LP3ETR.

³ Four-digit lot number represented by XXXX.