

编号	SCTF2022LC011
日期	2022/4/24
版本	B01

承认书

SPECIFICATION FOR APPROVAL

客户名称 Customer Name:	立创商城
供应商物料名称 Part Name:	石英晶体振荡器
产品描述 Description:	SMD3225 12.500MHz/3.3V
供应商物料料号 Part NO.:	S3D12.500000B20F30T
供应商名称 Supplier Name :	深圳市星通时频电子有限公司

PLEASE CONFIRM OUR SPECIFICATION. 敬请确认规格书之内容。

CUSTOMER APPROVAL 客户审批		
物料代号 PART NO. _____		
使用于机型 USED IN MODEL: _____		
工程部	品质部	采购部

(敬请承认后返回一份, 谢谢!)

SUPPLIER APPROVAL 供应商审批		
DGN.制表人	CKD. 校对	APPD. 审核、签章
吴丽红	李霞	胡华才

地址: 深圳市南山区龙珠四路方大城T2栋10楼

Add: 10 / F, Building T2, Fangdacheng, Longzhu 4th Road, Nanshan District, Shenzhen, China.

Website: www.sctf-crystal.com

Email: info@sctf-crystal.com

TEL: 0755-86097430

FAX: 0755-86097259

Page: 1

RoHS Compliant

Revision Record				
Rev.	Revise page 修订页	Revise contents 修订内容	Rev. Date 修订日期	Reviser 修订人
A02	N/A	Initial released.	2013/1/1	Martin.Hu
A03	N/A	The version is upgraded and the content remains unchanged.	2018/2/25	Martin.Hu
B01	Page2	The version is upgraded and add revision record page.	2021/2/24	Martin.Hu

SHENZHEN SCTF ELECTRONICS CO., LTD		
DATE	Specification of quartz crystal oscillator 石英晶体振荡器规格书	Page:
2022/4/24	P/N: S3D12.500000B20F30T Spec.NO.: SCTF2022LC011	2

■ Electrical Specification 电气参数

N0.	Item	Electrical Spec.	Notes
1	Holder Type 封装	SMD3225	
2	Nominal Frequency 标称频率	12.500000 MHz	
3	Frequency stability 常温频差	±20PPM	at 25°C±2°C
4	Temperature Drift 温度频差	±30PPM	at -40~85°C
5	Operating voltage 工作电压	3.3V	±10% max.
6	Output 输出模式	CMOS	
7	Output load condition 负载	15pF	
8	Current consumption 消耗电流	10 mA max.	
9	Operating temperature range 工作温度范围	-40~85°C	
10	Storage Temperature Range 存储温度范围	-55~125°C	
11	Duty Cycle 占空比	45%-55%	
12	Rise / Fall Time 上升/下降沿时间	5 nS max.	
13	High output voltage 高电平	0.9Vdd min.	
14	Low output voltage 低电平	0.1Vdd max.	
15	Start-up Time 起振时间	5mS max.	To 90% of Final Amplitude
16	Enable Voltage High (Logic 1) 使能高电平	70%Vdd min.	Output will be enable if OE is Logic 1 or open ; Output will be disable if OE is Logic 0.
17	Enable Voltage Low (Logic 0) 使能低电平	30%Vdd max..	输出使能OE是高电平1或者悬空，频率输出； 输出使能OE是低电平0，则无频率输出。
18	Enable Delay Time 使能延迟	150 uS max.	
19	Aging 老化	±3ppm	1st. Year at 25°C

SHENZHEN SCTF ELECTRONICS CO. , LTD

DATE	Specification of quartz crystal oscillator 石英晶体振荡器规格书	Page:
2022/4/24	P/N: S3D12.500000B20F30T Spec.NO.: SCTF2022LC011	3

■ DIMENSIONS 产品尺寸

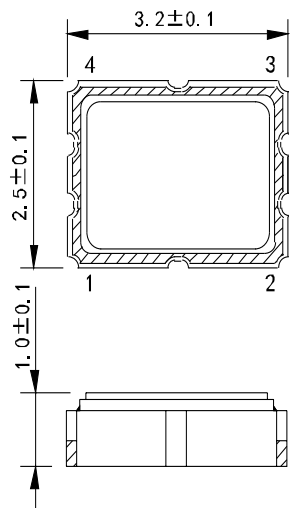

Units (单位): mm(毫米)

Pad Functions:

1. ENABLE CONTROL
2. GND
3. OUT PUT
4. VDD

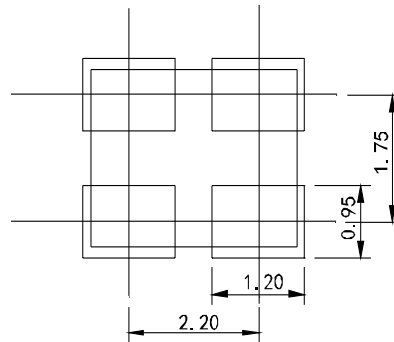
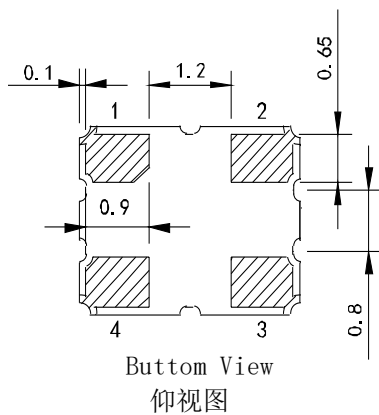
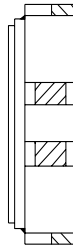

※ Notes: PIN 1 connected to Vdd or floating, the product is working properly;connected to GND,stops working.

■ TESTING CIRCUIT 测试电路

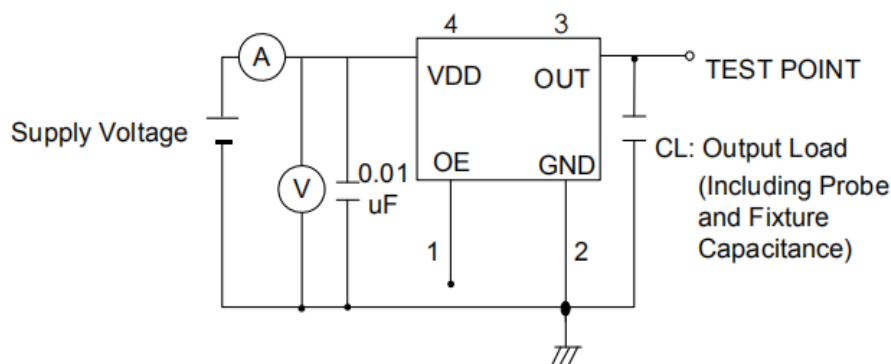

SHENZHEN SCTF ELECTRONICS CO. , LTD

DATE	Specification of quartz crystal oscillator 石英晶体振荡器规格书	Page:
2022/4/24	P/N: S3D12.500000B20F30T Spec.NO.: SCTF2022LC011	4

■ WAVEFORM CONDITIONS 输出波形



Waveform measurement system should have a min. bandwidth of 5 times the frequency being tested.

■ Product Structure

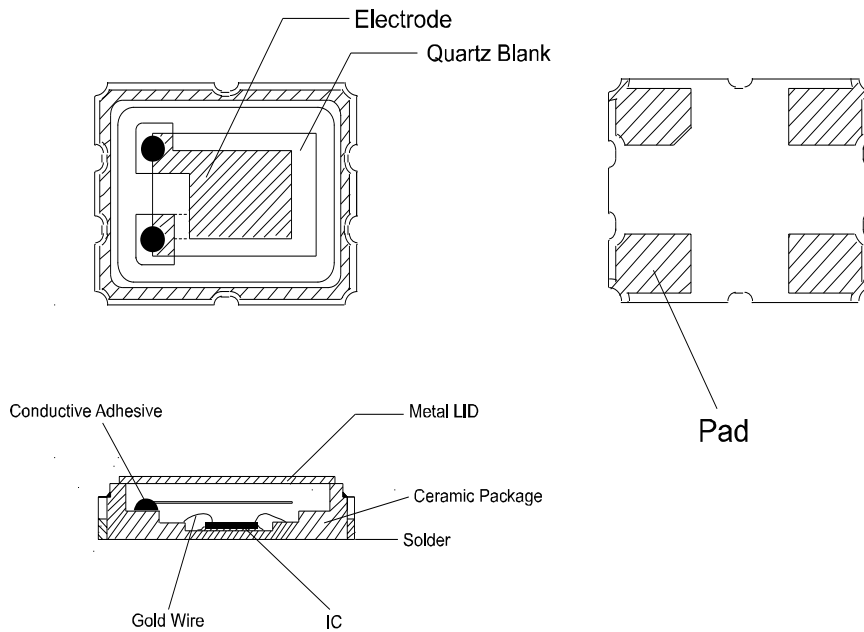

■ Marking

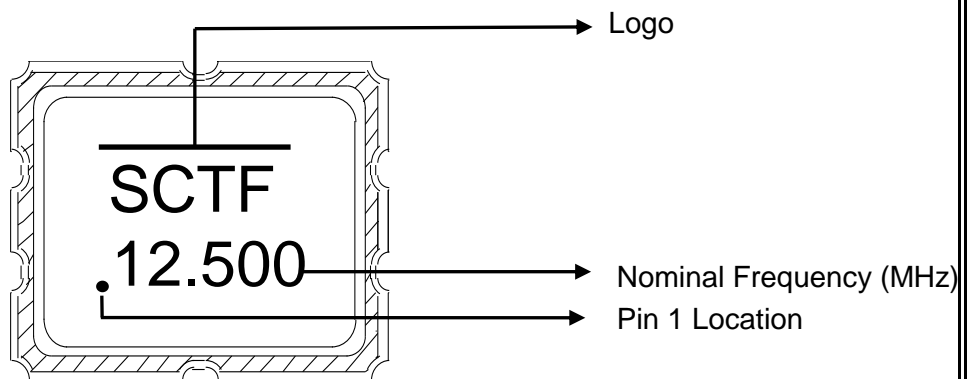

SHENZHEN SCTF ELECTRONICS CO. , LTD		
DATE	Specification of quartz crystal oscillator 石英晶体振荡器规格书	Page:
2022/4/24	P/N: S3D12.500000B20F30T Spec.NO.: SCTF2022LC011	5

REFLOW PROFILES 回流焊条件

Profile Feature	Sn-Pb Eutectic Assembly	Pb-Free Assembly
Preheat/Soak		
●Temperature Min(Ts min)	100 °C	150 °C
●Temperature Max (Ts max)	150 °C	200 °C
●Time (Ts min to Ts max)	60-120 seconds	60-120 seconds
Ramp-up rate (TL to Tp)	3 °C/second max.	3 °C/second max.
Time maintained above		
●Liquidous temperature (TL)	183 °C	217 °C
●Time (tL) maintained above TL	60-150 seconds	60-150 seconds
Peak package body temperature (Tp)	235 °C	260 °C
Time within 5 °C of the specified classification temperature (Tp)	20 seconds	30 seconds
Ramp-down rate (Tp to TL)	6 °C/second max.	6 °C/second max.
Time 25 °C to peak temperature	6 minutes max.	8 minutes max.
Suggest reflow times	3 Times max.	

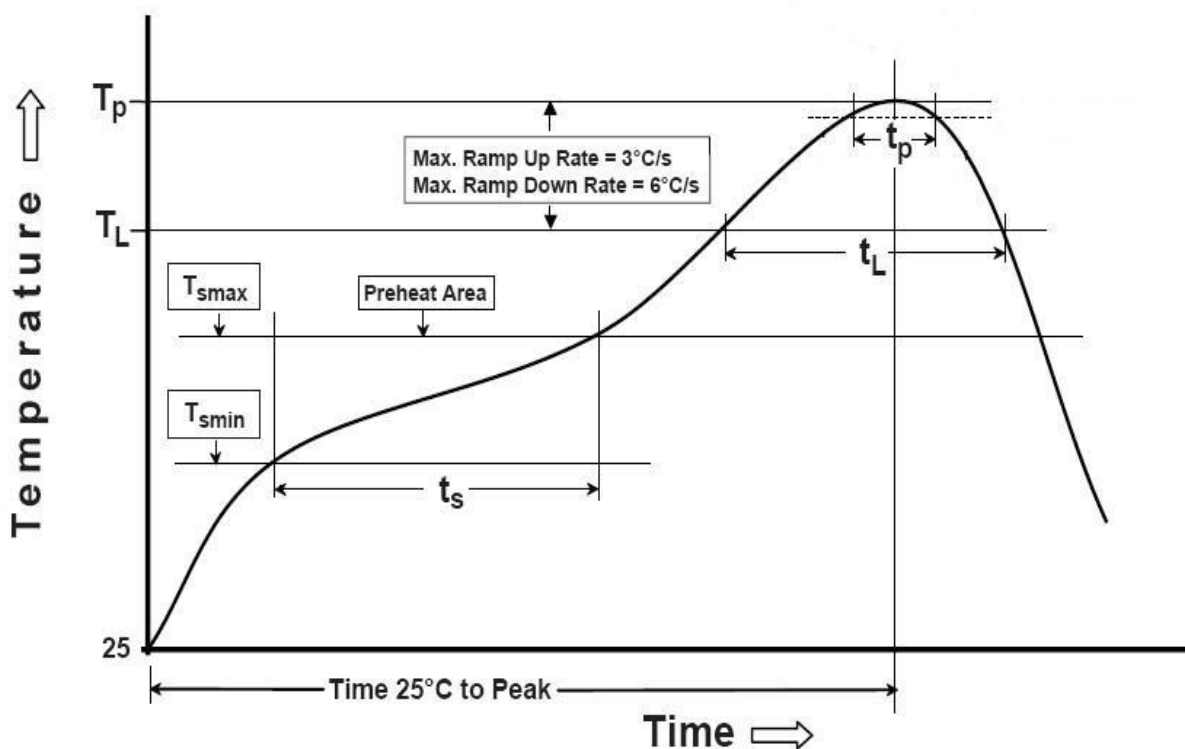

SHENZHEN SCTF ELECTRONICS CO. , LTD		
DATE	Specification of quartz crystal oscillator 石英晶体振荡器规格书	Page:
2022/4/24	P/N: S3D12.500000B20F30T Spec.NO.: SCTF2022LC011	6

■ RELIABILITY SPECIFICATION可靠性参数

序号 NO.	项目 ITEM	条件 CONDITIONS	合格标准 BASIS OF VERDICT
1	跌落 DROP	100cm高处自由跌落到3cm厚木板上,3次 High:100cm;Thickness:3cm;3 times.	$\Delta FL \leq \pm 5 \text{ppm}$
2	振动 VIBRATION	频率 Frequency:10~57.7Hz:幅度 Amplitude: $\pm 0.75 \text{mm}$ 频率Frequency:57.7Hz~500Hz:加速度幅度acceleration rate:98m/s ² 周期 Cycle time:10-500-10Hz: 15min 振动方向 Direction:X,Y, Z 振动时间 Duration: 每个方向2小时 2 h/direction.	$\Delta FL \leq \pm 5 \text{ppm}$
3	温度变化 TEMPERATURE SHOCK	-40°C $\pm 2^\circ\text{C}$ (30min) \leftrightarrow 85°C $\pm 2^\circ\text{C}$ (30min);循环10次 -40°C $\pm 2^\circ\text{C}$ (30min) \leftrightarrow 85°C $\pm 2^\circ\text{C}$ (30min);For 10 cycles	$\Delta FL \leq \pm 5 \text{ppm}$
4	湿热 HUMIDITY	温度:40°C $\pm 2^\circ\text{C}$;湿度90-95%;时间:96小时 Temp:40°C $\pm 2^\circ\text{C}$;Humidity:90-95%;Times:96h	$\Delta FL \leq \pm 5 \text{ppm}$
5	低温 COLD RESISTANCE	温度:-40°C $\pm 2^\circ\text{C}$;时间:96小时 Temp:-40°C $\pm 2^\circ\text{C}$;Times:96h	$\Delta FL \leq \pm 5 \text{ppm}$
6	高温1 HEAT RESISTANCE 1	温度:100°C $\pm 2^\circ\text{C}$;时间:96小时 Temp:100°C $\pm 2^\circ\text{C}$;Times:96h	$\Delta FL \leq \pm 5 \text{ppm}$
7	高温2 HEAT RESISTANCE 2	温度:155°C $\pm 2^\circ\text{C}$;时间:2小时 Temp:155°C $\pm 2^\circ\text{C}$;Times:2h	$\Delta FL \leq \pm 5 \text{ppm}$
8	高温3 HEAT RESISTANCE 3	温度:85°C $\pm 2^\circ\text{C}$;电压:3.3V/5.0V;时间:96小时 Temp:85°C $\pm 2^\circ\text{C}$;Voltage:3.3V/5.0V;Times:96h	$\Delta FL \leq \pm 5 \text{ppm}$
9	回流焊 REFLOW	150°C $\pm 5^\circ\text{C}$ 保持120s后升到270°C $\pm 5^\circ\text{C}$ 保持10s, 升温 and 保温时间小于200s, 常温放置1~2h后测定 Keep 150 °C \pm 5 °C 120s and then rose to 270 °C \pm 5 °C for 10s, warming and holding time is less than the 200s, placed at room temperature 1 ~ 2h after test	$\Delta FL \leq \pm 5 \text{ppm}$
10	盐雾 SALT SPRAY	盐雾浓度:5%;温度:35°C;时间:24小时 Salt density:5%;Temp:35°C;Times:24h	目测无明显腐蚀现象 Visual no significant corrosion.
11	老化 AGING	温度:85°C;时间:30天 Temp:85°C;Times:30days	$\Delta FL \leq \pm 5 \text{ppm}$
12	气密性 LEAKAGE	氦气(0.6~0.65MPa):10分钟 He(0.6~0.65MPa):10min	$\leq 3 \times 10^{-9} \text{Pa} \cdot \text{m}^3/\text{s}$
13	焊接 SOLDER	温度:260°C $\pm 5^\circ\text{C}$ Temp:260°C $\pm 5^\circ\text{C}$	浸锡率大于90% Soldering tin rate greater than 90%

SHENZHEN SCTF ELECTRONICS CO. , LTD

DATE	Specification of quartz crystal oscillator 石英晶体振荡器规格书	Page:
2022/4/24	P/N: S3D12.500000B20F30T Spec.NO.: SCTF2022LC011	7

■ Taping Specifications

UNIT(单位):mm(毫米)

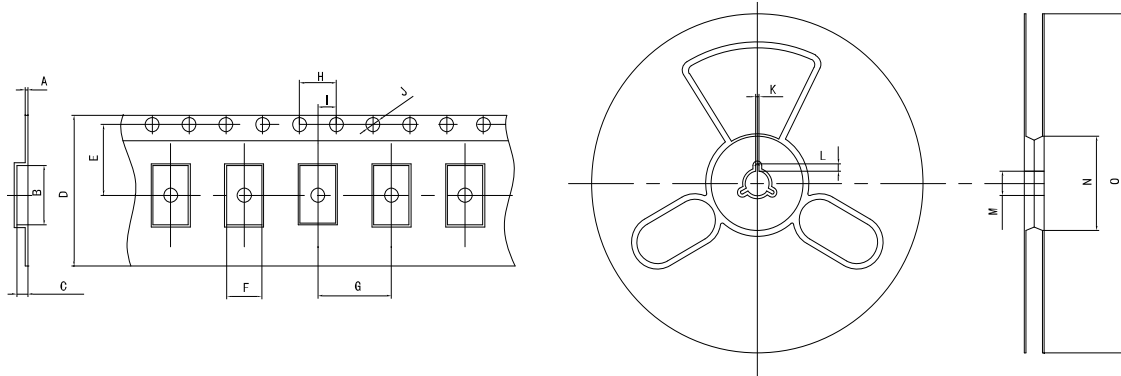

TEYE	A	B	C	D	E	F	G	H	I	J	K	L	M	N	O
3.2×2.5 SMD	0.25	3.60	1.30	8.00	3.50	2.90	4.00	4.00	2.00	1.50	2.00	4.00	13.00	60.00	180.00

■ Packaging specifications



自封袋(Bag)
3000只 = 1 轮
3000pcs = 1 Reel

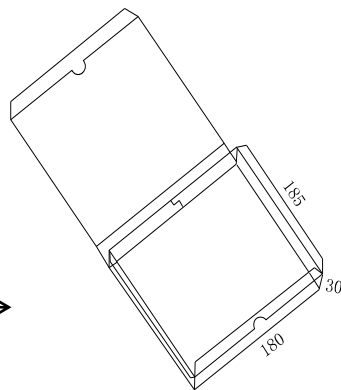

内包装(Inside package)
1 轮=1 盒
1 Reel=1 box

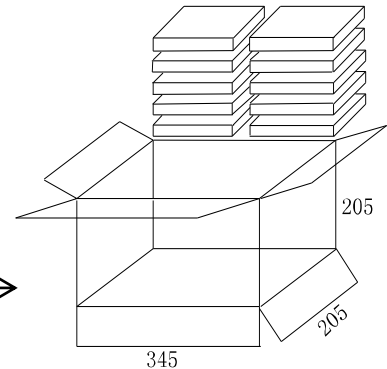

外包装(Outside Package)
10 盒=1 箱
10 box=1 carton

SHENZHEN SCTF ELECTRONICS CO. , LTD		
DATE	Specification of quartz crystal oscillator 石英晶体振荡器规格书	Page:
2022/4/24	P/N: S3D12.500000B20F30T Spec.NO.: SCTF2022LC011	8