



承认书

APPROVAL SHEET

客户名称:

Customer

产品名称:

功率电感器

Part Name

Power Inductor

客户料号:

Customer P/N

物料描述:

Material description

产品规格:

PIM201610-S00 Series

Specification

版本号:

22.01

Version No.

日期:

2022-1-28

DATE

制造 Manufacturer			客户 Customer		
拟制 Draft by	审核 Checked by	确认 Approve by	检验 Check by	审核 Checked by	批准 Approval by
唐程华	冯东梅	冯东梅			





履历表
Resume

版本	修改 明 细	修改	日期
Ver. No.	Modify Details	Reviser	Date
22.01	首次发行 Initial issue	唐程华	2022-1-28



目 录 TABLE OF CONTENTS

- 1 适用范围 Scope
- 2 型号表示办法 How To Order
- 3 尺寸与结构 External Dimensions and Structural Diagram
- 4 测试条件 Testing conditions.
- 5 工作温度范围 Operating Temperature Range
- 6 电气性能 Performance Specification
- 7 可靠性 Reliability Data
- 8 包装 Package
- 9 环保情况说明 Environmental Protection Statement
- 10 推荐使用的焊接曲线 Recommended soldering profile
- 11 清洗 Cleaning
- 12 贮存方法 Storage Methods
- 13 使用注意事项 Precautions For Use



1. 适用范围 Scope.

本规格书适用于 PIM201610-S00 系列贴片功率电感器。

This specification applies to the PIM201610-S00 series of SMD power inductors.

2. 型号表示办法 How To Order.

PIM 201610 - 1R0 □ T □□□

① ② ③ ④ ⑤ ⑥

①产品代号, Product symbol.

②尺寸代码, Dimension code, 长度、宽度、厚度, Length /width /thickness.

③电感量标称值, Inductance, 1R0→1.0μH, 100→10μH, 101→100μH.

④电感量公差代码, Inductance Tolerance code, N ±30%, M ±20%.

⑤包装代码, T-编带卷盘; Packing code: T-Tape & reel.

⑥内部代码, Internal code.

3. 尺寸与结构 External Dimensions and Structural Diagram. 单位 Unit: mm

3.1. 尺寸 External Dimensions

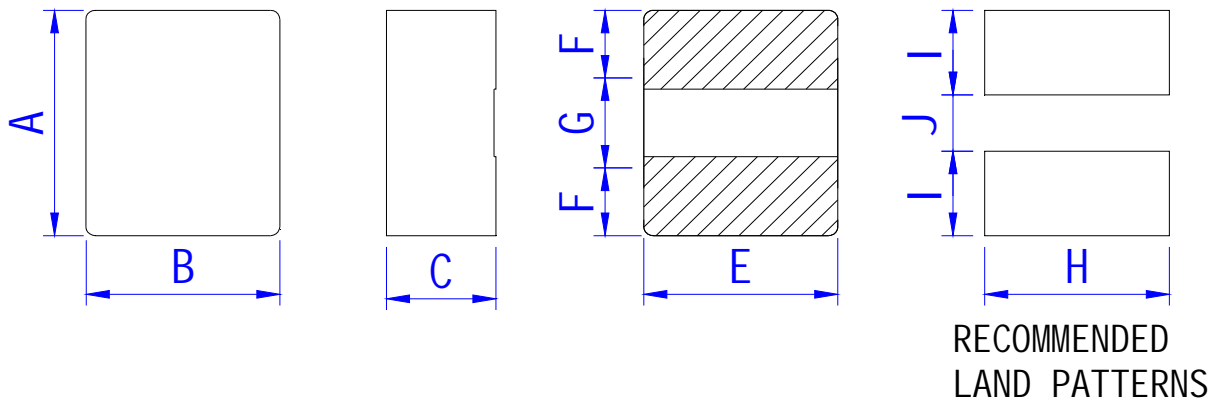

顶部印字 Marking: 不印字

A	B	C	E	F	G	H	I	J
2.0±0.2	1.6±0.2	1.00MAX	Typical 1.60	Typical 0.70	Typical 0.60	Typical 1.80	Typical 0.85	Typical 0.50



3.2. 结构图 Structural drawing:

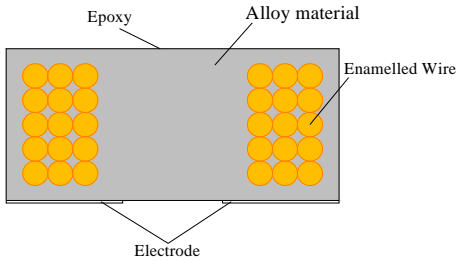

No.	部位 Component	材料 Material
①	本体 Body	合金材料 Alloy material
②	线圈 Winding	漆包线 Enamelled Wire
③	涂层 Shield	环氧树脂 Epoxy
④	电极 Electrode	底层—铜层 Base plating—Cu 镀层—镍层 Base plating—Ni 镀层—锡层 Base plating—Sn

4. 测试条件 Testing conditions.

4.1. 除非另有规定，否则在以下条件下测试. Unless otherwise specified

温度：常温 Temperature : Ordinary Temperature	20±15 °C
湿度：常湿 Humidity: Ordinary Humidity	65±20 % RH

4.2. 当对测量结果有疑问时 In case of doubt

温度 Temperature	20±2 °C
湿度 Humidity	65±5 % RH
大气压 Atmospheric Pressure	86 to 106 kPa

4.3. 测试示意图 Test schematic diagram.

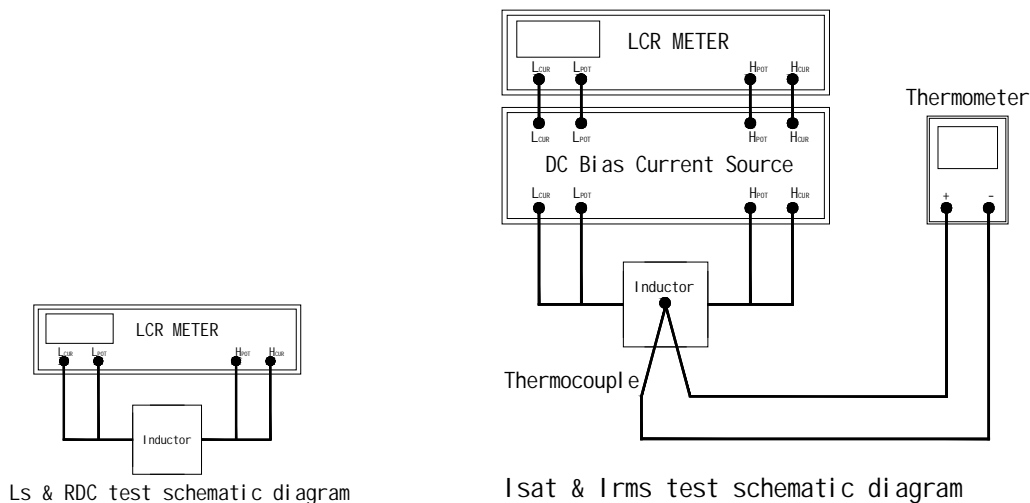



5. 工作温度范围 Operating Temperature Range

-40℃ ~ +125℃, 包括自身发热。Including self-heating

6. 电气性能 Performance Specification

客户料号 Customers Part No.	风华型号 Fenghua Part No.	电感量 Inductance Ls (μH)		直流电阻 Direct Current Resistance RDC (mΩ)		饱和电流 Saturation Current Isat (A)	温升电流 Temperature Rise Current Irms (A)	印字 Marking
				Max.	Typ.	Max.	Max.	
	PIM201610-R22MTS00	0.22	±20%	19	12	6.30	5.80	---
	PIM201610-R24MTS00	0.24	±20%	19	12	6.30	5.80	---
	PIM201610-R33MTS00	0.33	±20%	22	17	6.20	5.30	---
	PIM201610-R47MTS00	0.47	±20%	25	22	6.00	5.60	---
	PIM201610-R68MTS00	0.68	±20%	32	25	5.50	5.00	---
	PIM201610-1R0MTS00	1.00	±20%	43	35	4.20	4.10	---
	PIM201610-1R5MTS00	1.50	±20%	100	80	2.90	2.30	---
	PIM201610-2R2MTS00	2.20	±20%	150	120	2.80	2.10	---
	PIM201610-3R3MTS00	3.30	±20%	180	140	2.00	1.50	---
	PIM201610-4R7MTS00	4.70	±20%	250	210	1.50	1.15	---

测试条件与仪器 Test condition & equipment:

项目 Item	测试条件 Test condition	测试仪器 Test equipment
电感量 Ls	1MHz/1V	HP4263B\IM3532-50 or equivalent
直流电阻 RDC	直流电 direct-current	HP4263B\RM3545 or equivalent
饱和电流 Isat	1MHz/1V	Microtest 6379 & 6220 or equivalent
温升电流 Irms	ambient temperature 20℃	Microtest 6379 & 6220 or equivalent

Isat: 指使电感量比初始值下降约 30% 的电流值, 加载电流的时间 1 秒以内。

The DC current at which the inductance drops approximate 30% from its value without current, Load current time within 1 s.

Irms: 指使电感器表面温度上升 40℃ 的电流值。

The DC current is inductor surface temperature to rise by 40℃.



7. 可靠性 Reliability Data

序号 No.	项目 Items	要求 Requirements	试验方法及备注 Test Methods and Remarks
7.1	绝缘电阻 Insulation Resistance	$\geq 100\text{M}\Omega$	在电感器线圈和本体顶面中间施加 100 V 直流电压保持 60 s。 100 V DC between inductor coil and The middle of the top surface of the body for 60 seconds.
7.2	可焊性 Solderability	电极面 90%以上覆盖新的焊料。 90% or more of electrode area shall be coated by new solder.	在(245±5) °C 熔融的焊锡 (96.5Sn/3.0Ag/0.5Cu) 中浸(5±1) s。 Dip pads in flux and dip in solder pot (96.5Sn/3.0Ag/0.5Cu) at (245±5) °C for (5±1) seconds.
7.3	耐焊接热 Resistance to Soldering Heat	外观无可见机械损伤; 电感量变化率: ±10% 以内。 No visible mechanical damage. Inductance change: Within ±10%	在(260±5) °C 熔融的焊锡 (96.5Sn/3.0Ag/0.5Cu) 中浸(10±1) s。 Dip pads in flux and dip in solder pot (96.5Sn/3.0Ag/0.5Cu) at (260±5) °C for (10±1) seconds.
7.4	端子强度 Adhesion of terminal electrode	元件的端子与本体结合无松动、无 脱落。 Strong bond between the pad and the core, without come off PC board.	将电感器用(260±5) °C, (20±5) s 焊在带 有 0.3 mm 厚锡膏的基板上, 然后用治具 垂直电极面方向加压 10 N, (10±1) s。 Inductors shall be subjected to (260±5)°C for (20±5) s Soldering in the base whit 0.3mm solder. And then aplomb electrode way plus tax 10 N for (10±1) seconds.
7.5	耐高温 High temperature	外观无可见机械损伤; 电感量变化率: ±10% 以内。 No visible mechanical damage. Inductance change: Within ±10%	温度(+85 ± 2) °C, 时间(96±2) h; Temperature is (+85±2)°C and keep (96±2) hours.
7.6	耐低温 Low temperature	外观无可见机械损伤; 电感量变化率: ±10% 以内。 No visible mechanical damage. Inductance change: Within ±10%	温度(-40°C ± 2) °C, 时间(96±2) h; Temperature is (-40±2)°C and keep (96±2) hours.



(续上表 Continue on the table)

序号 No.	项目 Items	要求 Requirements	试验方法及备注 Test Methods and Remarks
7.7	温度变化 Thermal shock	外观无可见机械损伤；电感量变化率：±10%以内。 No visible mechanical damage. Inductance change: Within ±10%	(-40±3) °C,时间(30±3) min ↔ (125°C±2) °C/(30±3) min, 转换时间(2~3) min,循环32次； 在室温下放置 2 小时后、48 小时内测试。 The test sample shall be placed at (-40±3)°C and (125±2)°C for (30±3) min, different temperature conversion time is 2~3 minutes. The temperature cycle shall be repeated 32 cycles. Placed at room temperature for 2 hours, within 48 hours of testing.
7.8	温度特性 Temperature characteristic	电感量变化率 P_{c-b}, P_{c-d} 不超过 ±20%。 Inductance change P_{c-b}, P_{c-d} : Within ±20%	a: +20 °C (30~45) min → b: -40 °C (30~45) min → c: +20 °C (30~45) min → d: +125 °C (30~45) min → e: +20 °C (30~45) min $P_{c-b} = \frac{L_b - L_c}{L_c} \times 100\%$; $P_{c-d} = \frac{L_d - L_c}{L_c} \times 100\%$
7.9	恒定湿热 Static Humidity	外观无可见机械损伤；电感量变化率：±10%以内。 No visible mechanical damage. Inductance change: Within ±10%	将电感器放置在于湿度(93±3)%RH,温度(40±2) °C 的环境中存放(1000±2) h, 在室温下放置 2 小时后、48 小时内测试。 Inductors shall be subjected to (93±3)%RH . at (60±2)°C for (96±2) h . Placed at room temperature for 2 hours, within 48 hours of testing.
7.10	耐久性 (寿命) Life	外观无可见机械损伤；电感量变化率：±10%以内。 No visible mechanical damage. Inductance change: Within ±10%	温度(85 ±2)°C, 时间(1000±24) h,施加 Irms, 在室温下放置 2 小时后、48 小时内测试。 Inductors shall be store at (85±2)°C for (1000±24) hours with Irms applied. Placed at room temperature for 2 hours, within 48 hours of testing. 注：加载电流时零件表面温度超过 125°C 的，需要对电流降额到零件表面温度不超过 125°C。 Note: If the surface temperature of the part over 125 °C when the current is loaded, the current need to reduce until the surface temperature of the part less than 125 °C.



8. 包装 Package

8.1. 载带尺寸 Tape Dimension(单位：毫米 Unit:mm)

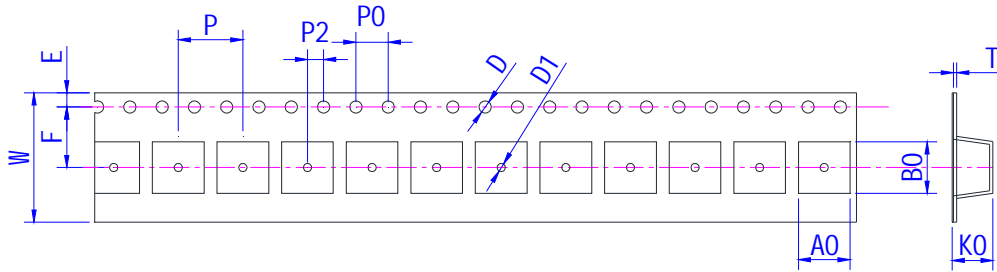

W	A0	B0	D	D1	E	F	K0	P0	P2	P	T
8±0.3	1.85±0.1	2.25±0.1	1.5±0.1	1.0MIN	1.75±0.1	3.5±0.1	1.15±0.1	4.0±0.3	2.0±0.3	4.0±0.3	0.25±0.05

8.2. 送料方向 Direction of feed(单位：毫米 Unit:mm)

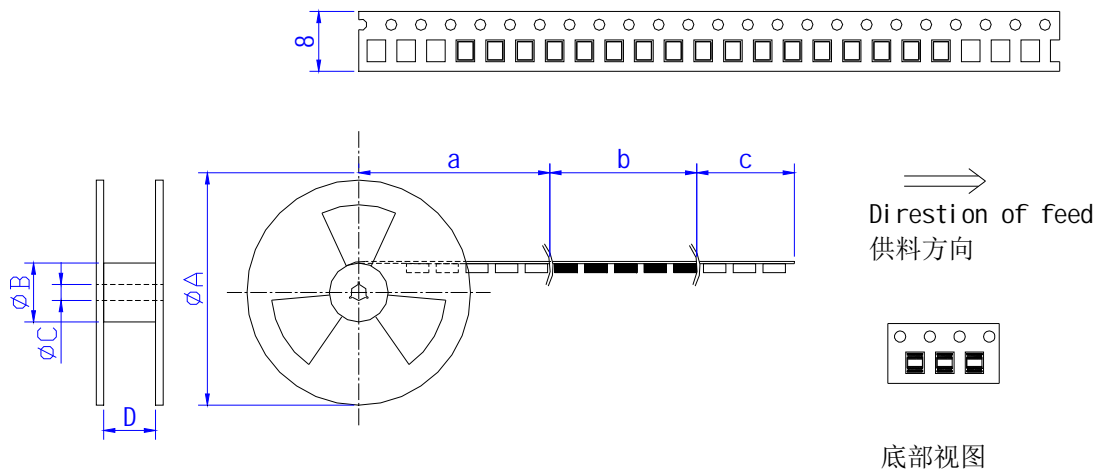

A	B	C	D	a	b	c
178	58	13	8.4	空带	装元件	引带
Typical	Typical	Typical	Typical	Blank portions	Chip cavity	Leader

8.3. 包装数量 Packing quantity

卷盘 REEL (PCS)	纸盒 BOX (PCS)	纸箱 Carton (PCS)
3,000	15,000	150,000

8.4. 剥离力要求 Peeling required

8.4.1. F 力大小 F force: 10~130g;

8.4.2. 面带剥离速度 Peeling speed: 300mm/min±10%;

8.4.3. 面带剥离角度 Peeling angle: 165°~180°.

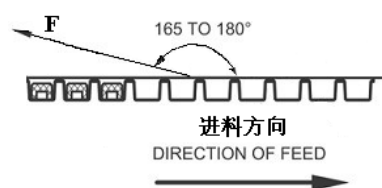



9. 环保情况说明 Environmental Protection Statement

RoHS 指令：公司产品符合 RoHS 指令。

Response to RoHS directive: Our products are RoHS compliance.

10. 推荐使用的焊接曲线 Recommended soldering profile

10.1. 本产品建议使用回流焊接法。

Applicable soldering process to the products is reflow soldering.

10.2. 焊接材料 Soldering Materials

(1) 焊料 Solder: Sn-3.0Ag-0.5Cu

(2) 助焊剂：使用松香基助焊剂，禁止使用卤化物含量超过 0.2wt% 的强酸性助焊剂和水溶性助焊剂。

Flux: Use rosin-based flux, but not strongly acidic flux (with chlorine exceeding 0.2 wt%). Do not use water-soluble flux.

10.3. 焊接曲线 Soldering Profile

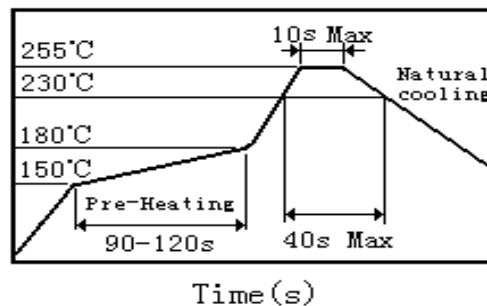

10.4. 烙铁焊接 Soldering Iron

使用烙铁进行返修时要求在 150°C 下预热至少 1 分钟，不能直接用焊头接触磁体，返修焊接条件如下：

Reworking with electric soldering iron must preheating at 150°C for 1 minute is required, and do not directly touch the core with the tip of the soldering iron. The reworking soldering conditions are as follows:

10.4.1. 烙铁头温度 Temperature of soldering iron tip: 350°C;

10.4.2. 烙铁输出功率 Soldering iron power output: $\leq 30W$;

10.4.3. 烙铁头直径 Diameter of soldering iron end: $\leq 1.0mm$;

10.4.4. 焊接时间 Soldering time: $< 3s$



11. 清洗 Cleaning

对本产品进行清洗操作前，需确认以下条件：

The following conditions should be observed when cleaning the products:

11.1. 清洗温度: $\leq 60^\circ C$ (酒精清洗剂 $\leq 40^\circ C$)

Cleaning Temperature: $60^\circ C$ max. ($40^\circ C$ max. for alcohol cleaning agents)

11.2. 超声波清洗, Ultrasonic:

输出 Output: 20 W/L max.

持续时间 Duration: 5 min max.

频率 Frequency: 28 to 40kHz

11.3. 清洗时要避免 PCB 板和安装产品的共振。Avoid the resonance between PCB and mounted products when it is cleaning.



12. 贮存方法 Storage Methods

12.1. 存储期限 Storage Period

为保证端子电极的焊接特性和包装材料处于良好状态，请于本公司发货后 6 个月内使用本产品。同时，由于端子电极的焊接特性会随时间发生变化，如果贮存时间超过 6 个月，请首先确认其焊接特性后再安装使用。

To maintain the solderability of terminal electrodes and to keep the packing material in good condition, product should be used within 6 months from the time of delivery. And the solderability of products electrodes may decrease as time passes, so in case of storage over 6 months, solderability shall be checked before actual usage.

12.2. 存储条件 Storage Conditions

12.2.1. 存放货物的仓库应满足以下条件：Store products in a warehouse in compliance with the following condition:

温度(Temperature): Inductors (product with taping) -10 to +40°C;

Inductors body -40 to +85°C.

相对湿度(Humidity): 30~70%RH.

12.2.2. 不要使产品遭受温度和湿度的快速变化。Do not subject products to rapid changes in temperature and humidity.

12.2.3. 不要将产品存放在化学环境中，如硫酸气体或碱性气体中，否则会降低电极端子的焊接特性和使电感器腐蚀。Do not store the products in chemical atmosphere such as one containing sulfurous acid gas or alkaline gas, that will causes poor solderability and corrosion of inductors.

12.2.4. 不要以散包装的形式存放产品以防止电感器间的相互碰撞造成磁芯破裂或断线。Do not store products in bulk packaging to prevent collision among inductors which causes core chipping and wire breakage.

12.2.5. 为了避免受潮气、灰尘等物质的影响，产品应保管于货架上。Store products on pallets to protect from humidity, dust, etc.

12.2.6. 产品应避免热冲击、振动以及直接光照等等。Avoid heat shock, vibration, direct sunlight, etc.

13. 使用注意事项 Precautions For Use

13.1. 本公司产品适用于 AV 设备、OA 设备、家电、信息服务等一般电子设备中。Our products are designed and promoted for use in general electronic devices such as audio-equipment, office automation equipment, household appliance and information service.

13.2. 当本公司的产品使用在一般电子设备以外的领域时，对于此所引发的设备失效我司将不承担任何法律责任。In case of using the product for the purpose other than general electronics devices, we shall not be held liable for any dysfunctions in or damage to the equipment with which the product is used.

13.3. 本承诺书只保证我司产品作为一个单体时的质量情况，当我司产品被安装到贵司产品上时，请贵司对使用在贵司电路上的产品情况进行了有效评价和确认。Our specification limits the quality of the component as a single unit. Please ensure the component is thoroughly evaluated in your application circuit.

13.4. 不要对产品施加过大的振动或机械冲击；Do not apply excessive vibration or mechanical shock to products.

13.5. 为防止断线，请不要使用锋利的物体接触线圈，如镊子；Do not touch wire with sharp objects such as tweezers to prevent wire breakage.

13.6. 在产品贴装时不要使用过大的压力，避免磁芯断裂。Do not apply excessive stress to products mounted on boards to prevent core breakage.