

20V P-Channel Enhancement Mode MOSFET

Description

The NP3415EMR uses advanced trench technology to provide excellent $R_{DS(ON)}$, low gate charge and operation with gate voltages as low as 1.8V. This device is suitable for use as a load switch or in PWM applications.

General Features

- ◆ $V_{DS} = -20V$, $I_D = -4A$
 $R_{DS(ON)}(Typ.) = 34m\Omega$ @ $V_{GS} = -4.5V$
 $R_{DS(ON)}(Typ.) = 44m\Omega$ @ $V_{GS} = -2.5V$
- ◆ High power and current handling capability
- ◆ Lead free product is acquired
- ◆ Surface mount package
- ◆ ESD Rating: 2500V HBM

Application

- ◆ PWM applications
- ◆ Load switch

Package

- ◆ SOT-23-3L



Schematic diagram

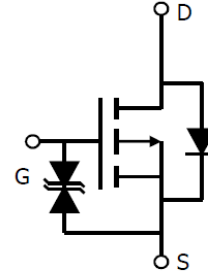

Marking and pin assignment

SOT-23-3L
(TOP VIEW)

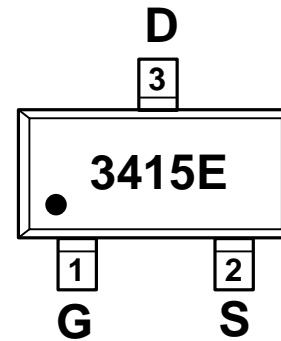

Ordering Information

Part Number	Storage Temperature	Package	Devices Per Reel
NP3415EMR-G	-55°C to +150°C	SOT-23-3L	3000

Absolute Maximum Ratings (TA=25°C unless otherwise noted)

parameter	symbol	limit	unit
Drain-source voltage	V_{DS}	-20	V
Gate-source voltage	V_{GS}	±8	V
Continuous Drain Current	I_D	$T_A = 25^\circ C$	-4
		$T_A = 70^\circ C$	-3
Pulsed Drain Current ^C	I_{DM}	-20	A
Maximum power dissipation ^B	P_D	$T_A = 25^\circ C$	1.4
		$T_A = 70^\circ C$	0.9
Operating junction Temperature range	T_j	-55—150	°C

Electrical Characteristics (TA=25°C unless otherwise noted)

Parameter	Symbol	Condition	Min	Typ	Max	Unit
OFF Characteristics						
Drain-source breakdown voltage	BV_{DSS}	$V_{GS}=0V, I_D=-250\mu A$	-20	-	-	V
Zero gate voltage drain current	I_{DSS}	$V_{DS}=-20V, V_{GS}=0V$	-	-	-1	μA
Gate-body leakage	I_{GSS}	$V_{DS}=0V, V_{GS}=\pm 8V$	-	-	± 10	μA
ON Characteristics						
Gate threshold voltage	$V_{GS(th)}$	$V_{DS}=V_{GS}, I_D=-250\mu A$	-0.4	-0.59	-0.9	V
Drain-source on-state resistance	$R_{DS(ON)}$	$V_{GS}=-4.5V, I_D=-4A$	-	34	45	m Ω
		$V_{GS}=-2.5V, I_D=-3A$	-	44	55	
Forward transconductance	g_{fs}	$V_{GS}=-5V, I_D=-4A$	8	-	-	S
Dynamic Characteristics						
Input capacitance	C_{ISS}	$V_{DS}=-10V, V_{GS}=0V$ $f=1.0MHz$	-	751	-	pF
Output capacitance	C_{OSS}		-	115	-	
Reverse transfer capacitance	C_{RSS}		-	80	-	
Switching Characteristics						
Turn-on delay time	$t_{D(ON)}$	$V_{DD}=-10V$ $I_D=-2.8A$ $V_{GEN}=-4.5V$ $R_L=10ohm$ $R_{GEN}=60ohm$	-	13	-	ns
Rise time	t_r		-	9	-	
Turn-off delay time	$t_{D(OFF)}$		-	19	-	
Fall time	t_f		-	29	-	
Total gate charge	Q_g	$V_{DS}=-10V, I_D=-3A$ $V_{GS}=-4.5V$	-	9.3	-	nC
Gate-source charge	Q_{gs}		-	1	-	
Gate-drain charge	Q_{gd}		-	2.2	-	
DRAIN-SOURCE DIODE CHARACTERISTICS						
Diode forward voltage	V_{SD}	$V_{GS}=0V, I_S=-1.25A$	-	-0.81	-1.2	V

Thermal Characteristics

Parameter	Symbol	Typ	Max	Unit
Maximum Junction-to-Ambient ^A	$R_{\theta JA}$	70	90	°C/W
Maximum Junction-to-Ambient ^{A D}		Steady-State	100	
Maximum Junction-to-Lead ^B	$R_{\theta JL}$	63	80	

A. The value of $R_{\theta JA}$ is measured with the device mounted on 1in2 FR-4 board with 2oz. Copper, in a still air environment with $T_A=25^\circ C$. The value in any given application depends on the user's specific board design.

B. The power dissipation P_D is based on $T_{J(MAX)}=150^\circ C$, using $\leq 10s$ junction-to-ambient thermal resistance.

C. Repetitive rating, pulse width limited by junction temperature $T_{J(MAX)}=150^\circ C$. Ratings are based on low frequency and duty cycles to keep initial $T_J=25^\circ C$.

D. The $R_{\theta JA}$ is the sum of the thermal impedance from junction to lead $R_{\theta JL}$ and lead to ambient.

Typical Performance Characteristics

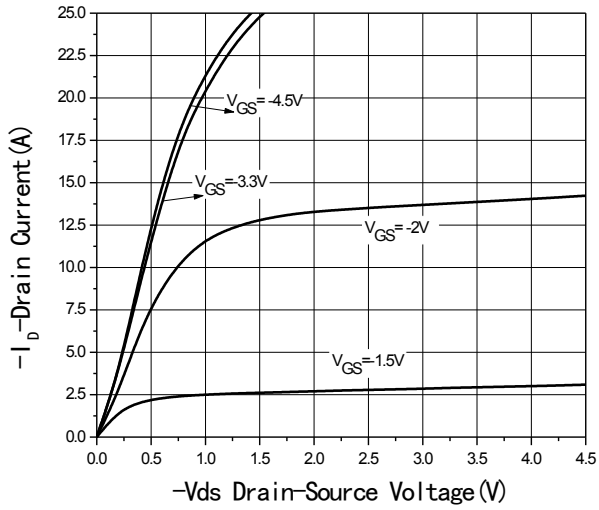

Fig1 Output Characteristics

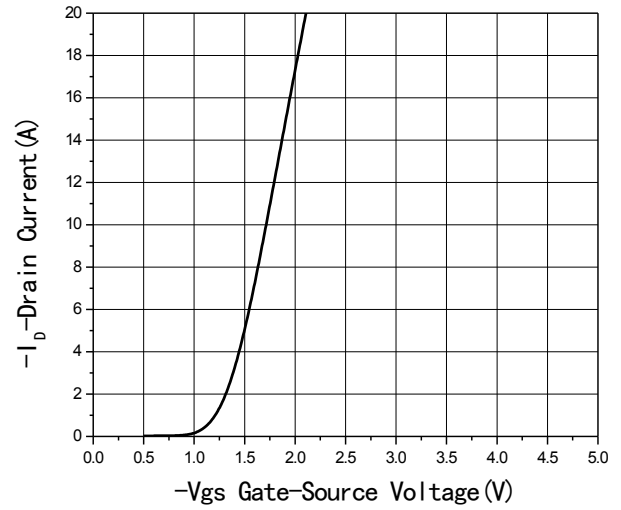

Fig2 Transfer Characteristics

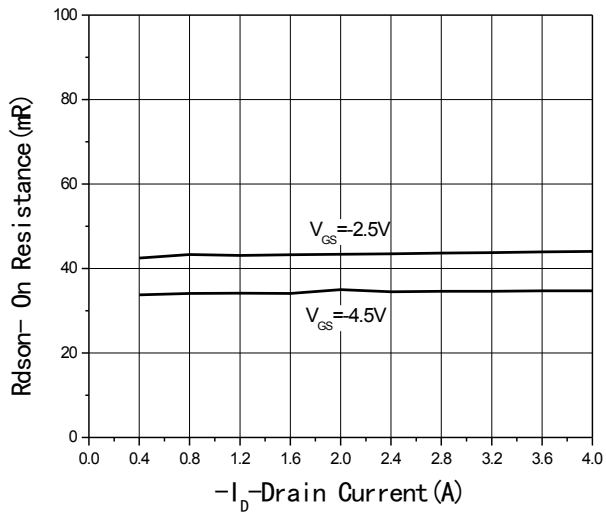

Fig3 $R_{ds(on)}$ -Drain current

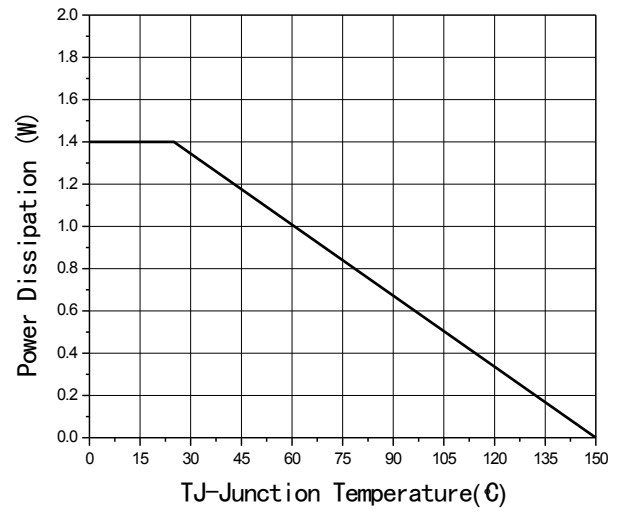

Fig4 Power De-rating

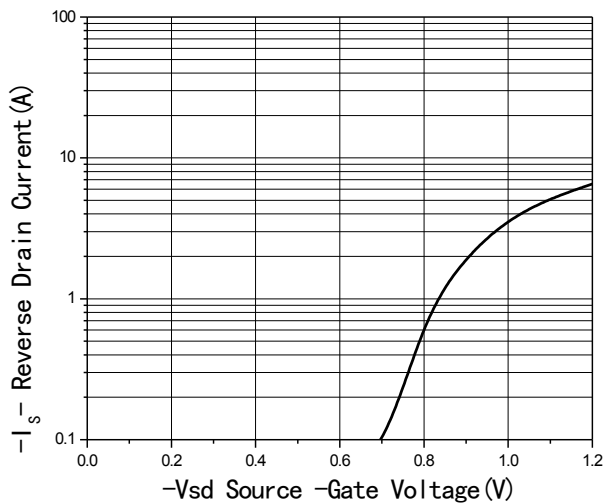

Fig5 Source-Drain Diode Forward

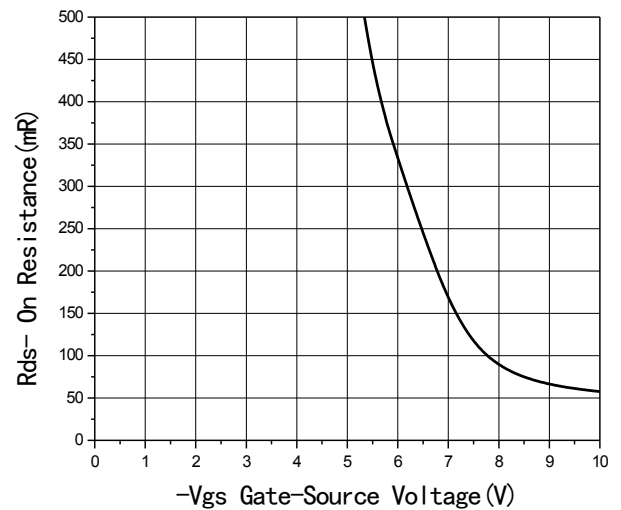

Fig6 $R_{ds(on)}$ -Gate Drain voltage

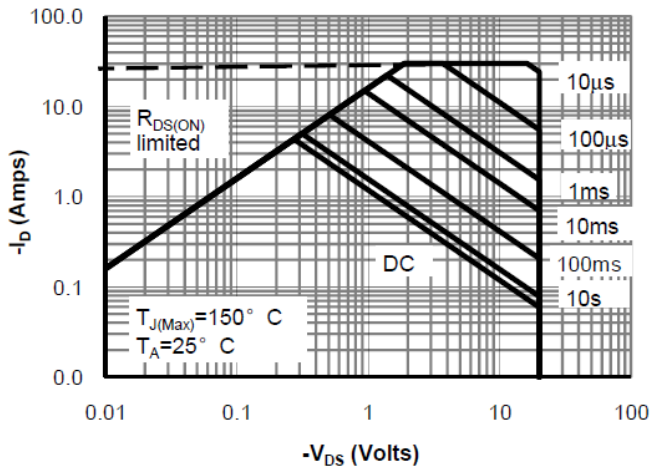

Figure 9: Maximum Forward Biased Safe Operating Area (Note F)

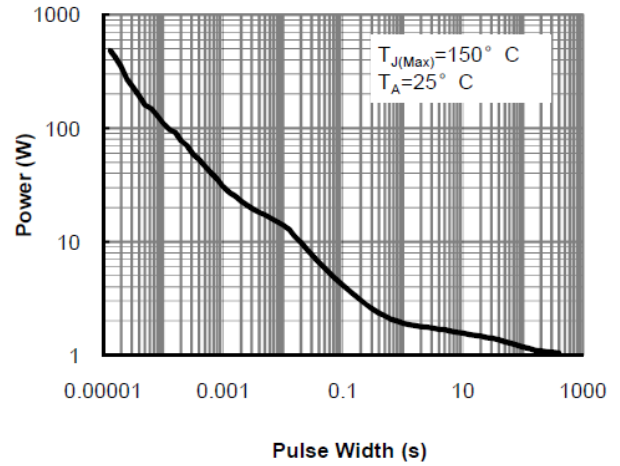

Figure 10: Single Pulse Power Rating Junction-to-Ambient (Note F)

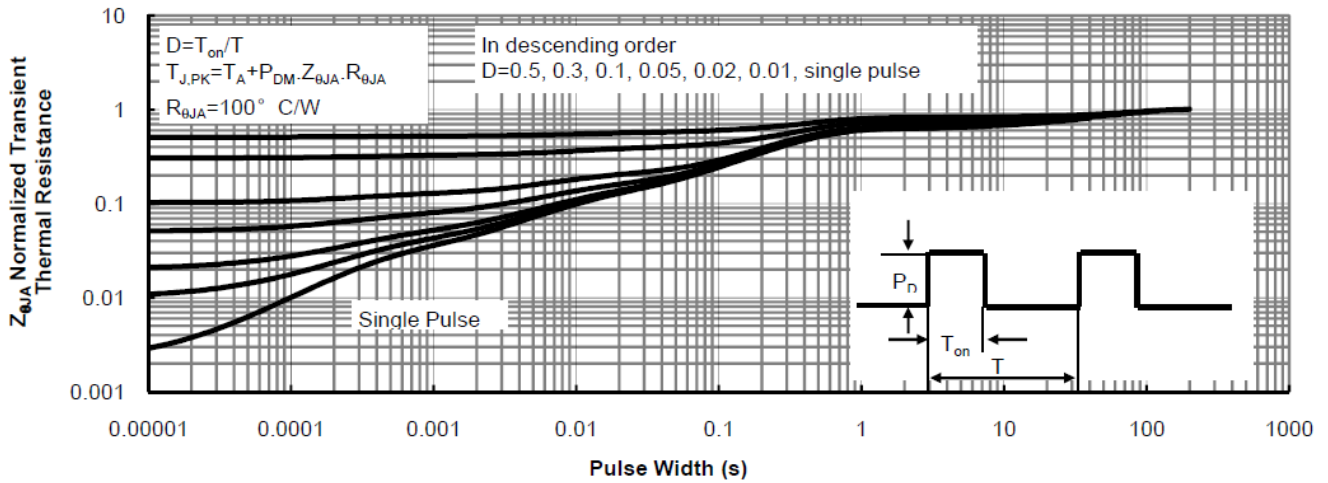
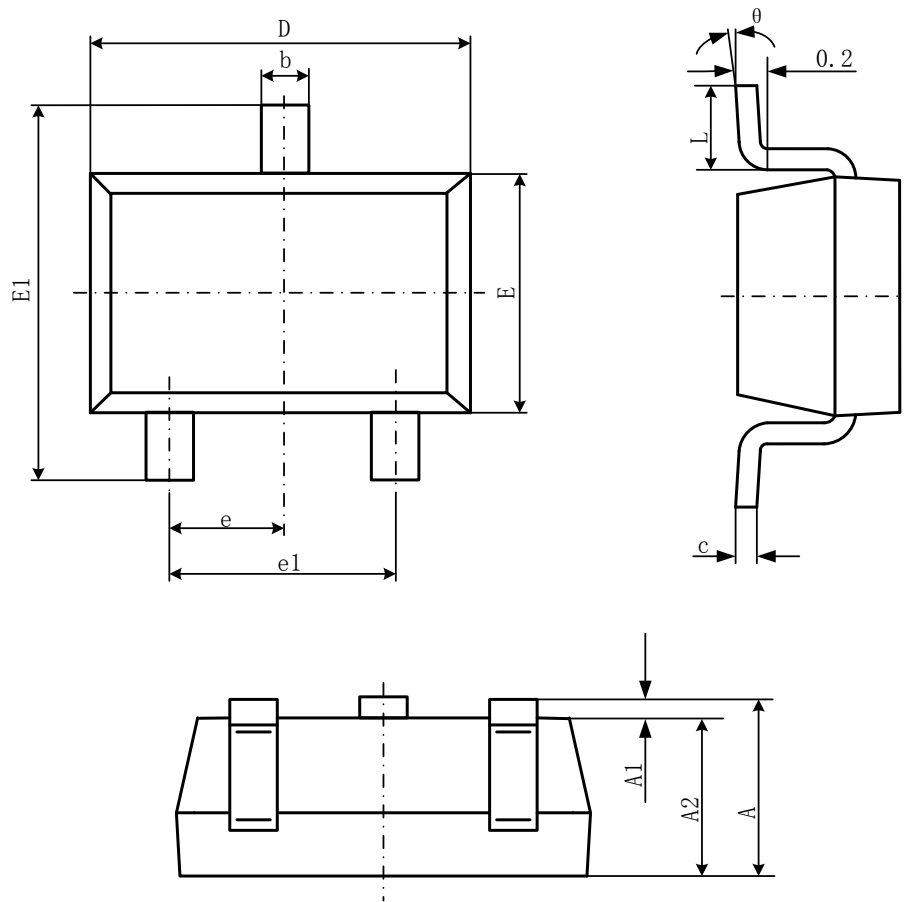

Figure 11: Normalized Maximum Transient Thermal Impedance (Note F)

Package Information

- SOT-23-3L



Symbol	Dimensions In Millimeters		Dimensions In Inches	
	Min	Max	Min	Max
A	1.050	1.250	0.041	0.049
A1	0.000	0.100	0.000	0.004
A2	1.050	1.150	0.041	0.045
b	0.300	0.500	0.012	0.020
c	0.100	0.200	0.004	0.008
D	2.820	3.020	0.111	0.119
E	1.500	1.700	0.059	0.067
E1	2.650	2.950	0.104	0.116
e	0.950(BSC)		0.037(BSC)	
e1	1.800	2.000	0.071	0.079
L	0.300	0.600	0.012	0.024
θ	0°	8°	0°	8°