

20V P-Channel Enhancement Mode MOSFET

Description

The NP2305MR uses advanced trench technology to provide excellent $R_{DS(ON)}$, low gate charge and operation with gate voltages as low as 1.8V. This device is suitable for use as a load switch or in PWM applications.

General Features

- ◆ $V_{DS} = -20V$, $I_D = -4A$
 $R_{DS(ON)}(Typ.) = 42m\Omega$ @ $V_{GS} = -4.5V$
 $R_{DS(ON)}(Typ.) = 55m\Omega$ @ $V_{GS} = -2.5V$
- ◆ High power and current handling capability
- ◆ Lead free product is acquired
- ◆ Surface mount package

Application

- ◆ PWM applications
- ◆ Load switch

Package

- ◆ SOT-23-3L



Schematic diagram

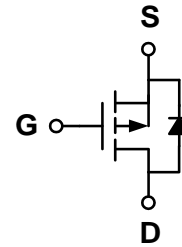

Marking and pin assignment

SOT-23-3L
(TOP VIEW)

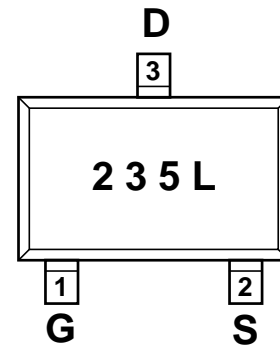

Ordering Information

Part Number	Storage Temperature	Package	Devices Per Reel
NP2305MR-G	-55°C to +150°C	SOT-23-3L	3000

Absolute Maximum Ratings (TA=25°C unless otherwise noted)

parameter	symbol	limit	unit
Drain-source voltage	V_{DS}	-20	V
Gate-source voltage	V_{GS}	± 12	V
Drain current-continuous ^a @Tj=125°C -pulse ^b	I_D	-4	A
	I_{DM}	-12	A
Drain-source Diode forward current	I_S	-1.25	A
Maximum power dissipation	P_D	1.2	W
Operating junction Temperature range	T_j	-55—150	°C

Electrical Characteristics (TA=25°C unless otherwise noted)

Parameter	Symbol	Condition	Min	Typ	Max	Unit
OFF Characteristics						
Drain-source breakdown voltage	BV_{DSS}	$V_{GS}=0V, I_D=-250\mu A$	-20	-	-	V
Zero gate voltage drain current	I_{DSS}	$V_{DS}=-20V, V_{GS}=0V$	-	-	-1	μA
Gate-body leakage	I_{GSS}	$V_{DS}=0V, V_{GS}=\pm 12V$	-	-	± 100	nA
ON Characteristics						
Gate threshold voltage	$V_{GS(th)}$	$V_{DS}=V_{GS}, I_D=-250\mu A$	-0.5	-0.85	-1.5	V
Drain-source on-state resistance	$R_{DS(on)}$	$V_{GS}=-4.5V, I_D=-4.2A$	-	42	50	m Ω
		$V_{GS}=-2.5V, I_D=-3A$	-	55	66	
Forward transconductance	g_{fs}	$V_{GS}=-5V, I_D=-2A$	-	5	-	S
Dynamic Characteristics						
Input capacitance	C_{ISS}	$V_{DS}=-10V, V_{GS}=0V$ $f=1.0MHz$	-	887	-	pF
Output capacitance	C_{OSS}		-	90	-	
Reverse transfer capacitance	C_{RSS}		-	81	-	
Switching Characteristics						
Turn-on delay time	$t_{D(on)}$	$V_{DS}=-10V$ $I_D=-2.8A$ $V_{GEN}=-4.5V$ $R_L=10\Omega$ $R_{GEN}=60\Omega$	-	12.5	-	ns
Rise time	t_r		-	35	-	
Turn-off delay time	$t_{D(off)}$		-	30	-	
Fall time	t_f		-	10	-	
Total gate charge	Q_g	$V_{DS}=-10V, I_D=-3A$ $V_{GS}=-4.5V$	-	21.1	-	nC
Gate-source charge	Q_{gs}		-	1.6	-	
Gate-drain charge	Q_{gd}		-	2.9	-	
DRAIN-SOURCE DIODE CHARACTERISTICS						
Diode forward voltage	V_{SD}	$V_{GS}=0V, I_s=-1.25A$	-	-0.81	-1.2	V

Notes:

- surface mounted on FR4 board, $t_s \leq 10sec$
- pulse test: pulse width $\leq 300\mu s$, duty $\leq 2\%$
- guaranteed by design, not subject to production testing

Thermal Characteristics

Thermal Resistance junction-to ambient	Rth JA	100	$^{\circ}C/W$
--	--------	-----	---------------

Typical Performance Characteristics

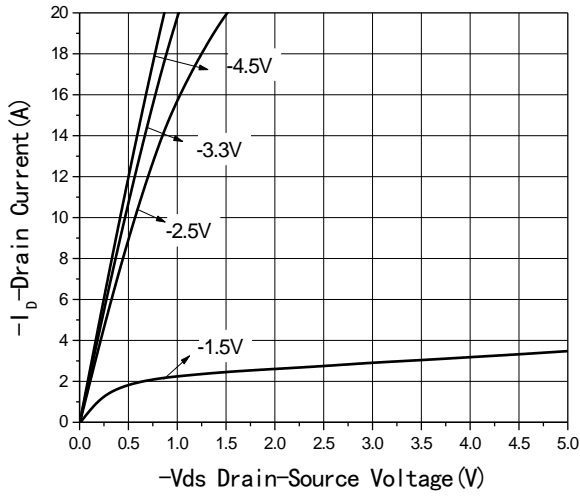

Fig1 Output Characteristics

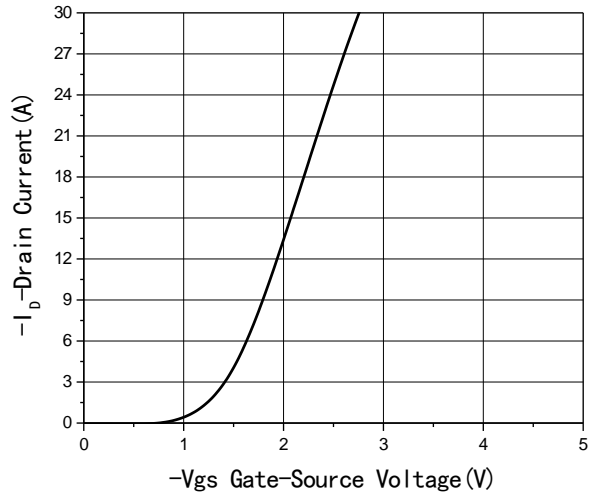

Fig2 Transfer Characteristics

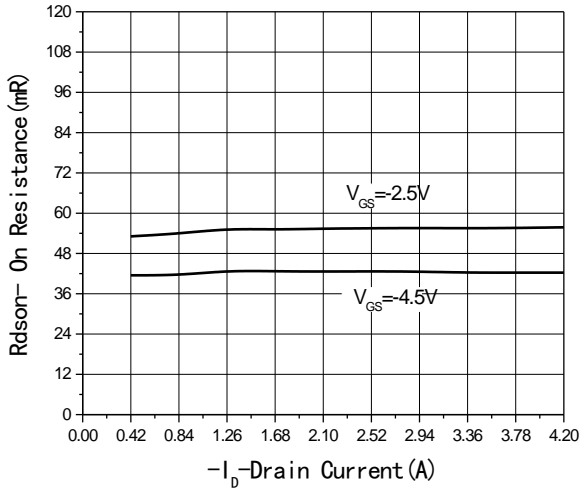

Fig3 $R_{DS(on)}$ -Drain current

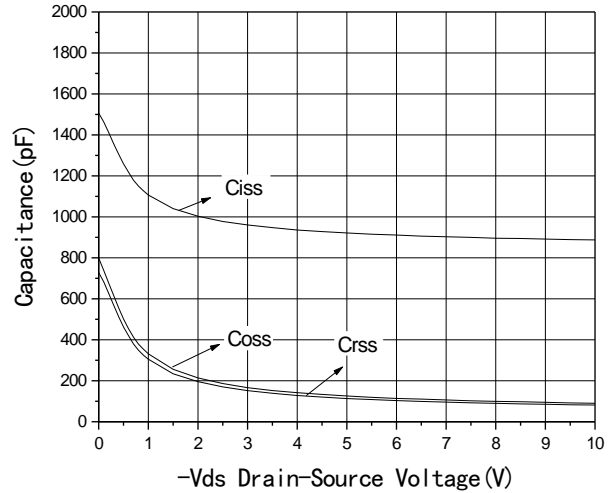

Fig4 Capacitance vs V_{DS}

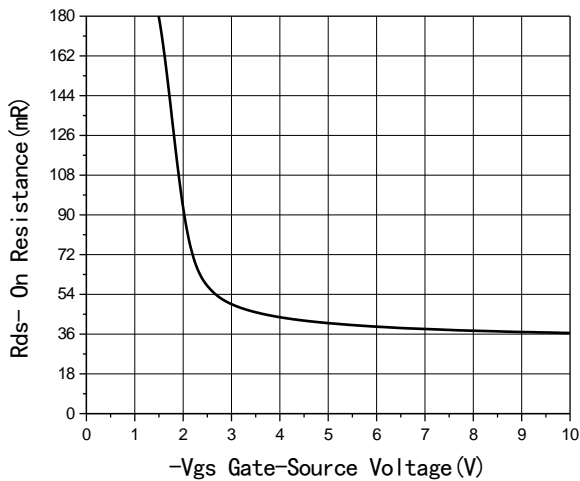

Fig5 $R_{DS(on)}$ -Gate Drain voltage

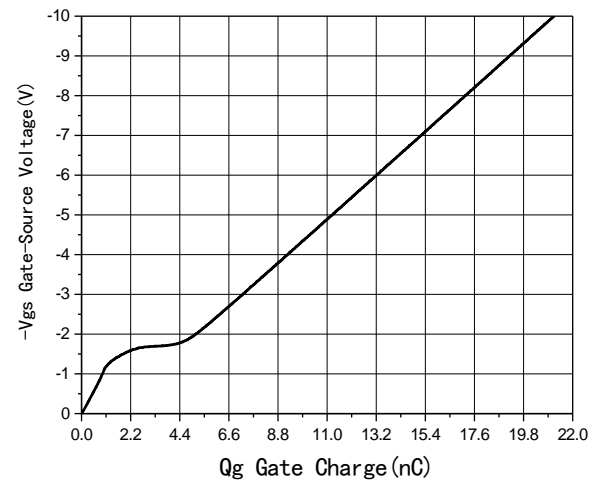

Fig6 Gate Charge

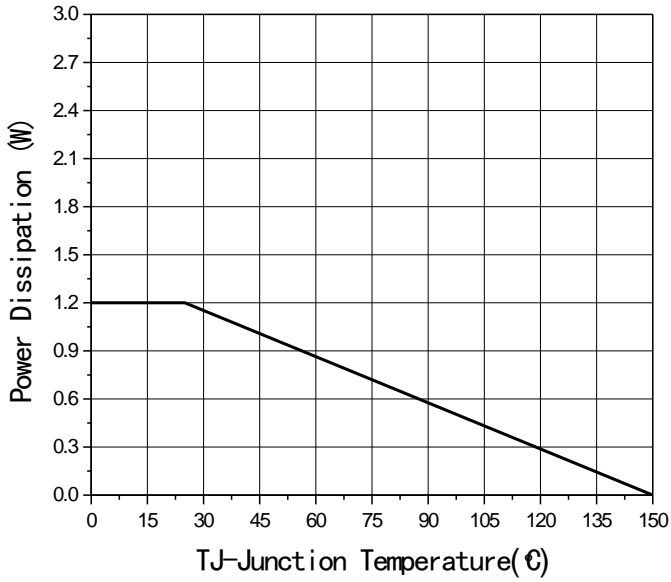

Fig7 Power De-rating

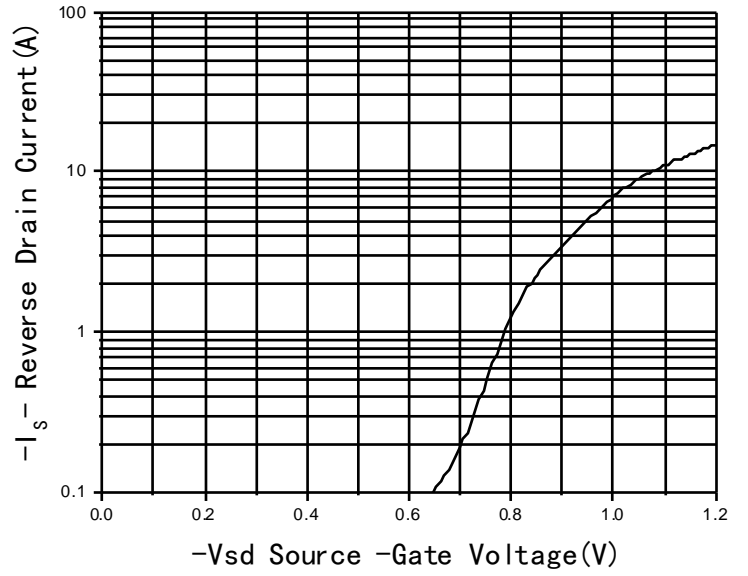
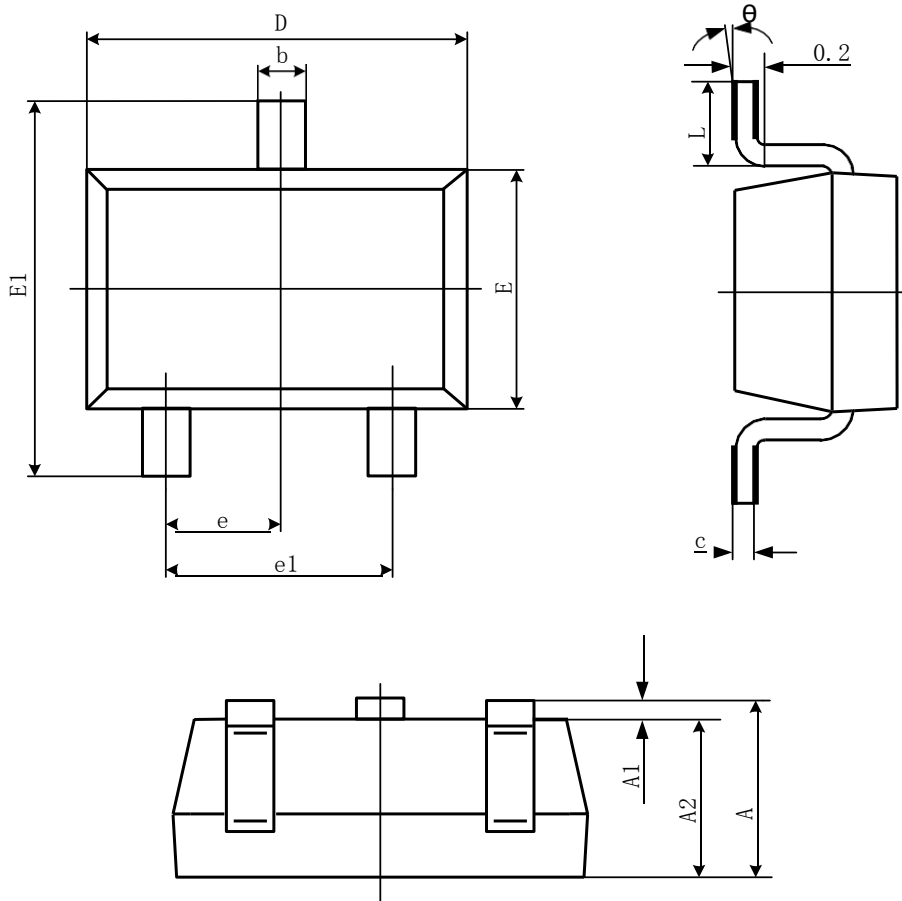

Fig8 Source-Drain Diode Forward

Package Information

- SOT-23-3L



Symbol	Dimensions In Millimeters		Dimensions In Inches	
	Min	Max	Min	Max
A	1.050	1.250	0.041	0.049
A1	0.000	0.100	0.000	0.004
A2	1.050	1.150	0.041	0.045
b	0.300	0.500	0.012	0.020
c	0.100	0.200	0.004	0.008
D	2.820	3.020	0.111	0.119
E	1.500	1.700	0.059	0.067
E1	2.650	2.950	0.104	0.116
e	0.950(BSC)		0.037(BSC)	
e1	1.800	2.000	0.071	0.079
L	0.300	0.600	0.012	0.024
θ	0°	8°	0°	8°