

## 20V N-Channel Enhancement Mode MOSFET

### Description

The NP2302FHR uses advanced trench technology to provide excellent  $R_{DS(ON)}$ , low gate charge and high density cell Design for ultra low on-resistance. This device is suitable for use as a load switch or in PWM applications.

### General Features

- ◆  $V_{DS} = 20V$ ,  $I_D = 3A$   
 $R_{DS(ON)}(Typ.) = 45m\Omega$  @  $V_{GS} = 4.5V$   
 $R_{DS(ON)}(Typ.) = 73m\Omega$  @  $V_{GS} = 2.5V$
- ◆ High power and current handling capability
- ◆ Lead free product is acquired
- ◆
- ◆ Surface mount package

### Application

- ◆ PWM applications
- ◆ Load switch

### Package

- ◆ ESOT-23-3L



### Schematic diagram

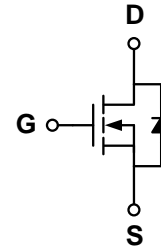

### Marking and pin assignment

ESOT-23  
(TOP VIEW)

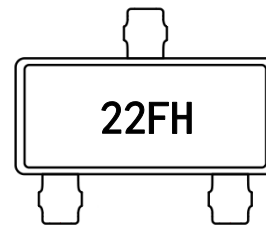

### Ordering Information

Part Number	Storage Temperature	Package	Devices Per Reel
NP2302FHR-G	-55°C to +150°C	ESOT-23-3L	5000

### Absolute Maximum Ratings (TA=25°C unless otherwise noted)

parameter	symbol	limit	unit
Drain-source voltage	$V_{DS}$	20	V
Gate-source voltage	$V_{GS}$	±12	V
Drain current-continuous <sup>a</sup> @ $T_j = 125^\circ C$ -pulse $d^b$	$I_D$	3	A
	$I_{DM}$	12	A
Drain-source Diode forward current	$I_S$	1.6	A
Maximum power dissipation	$P_D$	1.5	W
Operating junction Temperature range	$T_j$	-55—150	°C

**Electrical Characteristics** (TA=25°C unless otherwise noted)

Parameter	Symbol	Condition	Min	Typ	Max	Unit
<b>OFF Characteristics</b>						
Drain-source breakdown voltage	BV <sub>DSS</sub>	V <sub>GS</sub> =0V, I <sub>D</sub> =250μA	20	-	-	V
Zero gate voltage drain current	I <sub>DSS</sub>	V <sub>DS</sub> =20V, V <sub>GS</sub> =0V	-	-	1	μA
Gate-body leakage	I <sub>GSS</sub>	V <sub>DS</sub> =0V, V <sub>GS</sub> =±12V	-	-	±100	nA
<b>ON Characteristics</b>						
Gate threshold voltage	V <sub>GS(th)</sub>	V <sub>DS</sub> =V <sub>GS</sub> , I <sub>D</sub> =250μA	0.5	0.75	1.2	V
Drain-source on-state resistance	R <sub>DS(ON)</sub>	V <sub>GS</sub> =4.5V, I <sub>D</sub> =3A	-	45	66	mΩ
		V <sub>GS</sub> =2.5V, I <sub>D</sub> =3A		73	102	
Forward transconductance	gfs	V <sub>GS</sub> =5V, I <sub>D</sub> =3A	-	11	-	S
<b>Dynamic Characteristics</b>						
Input capacitance	C <sub>ISS</sub>	V <sub>DS</sub> =10V, V <sub>GS</sub> =0V f=1.0MHz	-	145	-	pF
Output capacitance	C <sub>OSS</sub>		-	26	-	
Reverse transfer capacitance	C <sub>RSS</sub>		-	22	-	
<b>Switching Characteristics</b>						
Turn-on delay time	t <sub>D(ON)</sub>	V <sub>DD</sub> =10V R <sub>L</sub> =3.3 ohm V <sub>GEN</sub> =4.5V R <sub>GEN</sub> =6ohm	-	2.3	-	ns
Rise time	t <sub>r</sub>		-	3.1	-	
Turn-off delay time	t <sub>D(OFF)</sub>		-	21	-	
Fall time	t <sub>f</sub>		-	2.6	-	
Total gate charge	Qg	V <sub>DS</sub> =10V I <sub>D</sub> =3A V <sub>GS</sub> =4.5V	-	4.8	-	nC
Gate-source charge	Qgs		-	0.3	-	
Gate-drain charge	Qgd		-	0.6	-	
<b>DRAIN-SOURCE DIODE CHARACTERISTICS</b>						
Diode forward voltage	V <sub>SD</sub>	V <sub>GS</sub> =0V, I <sub>S</sub> =3A	-	0.76	1.16	V

**Notes:**

- surface mounted on FR4 board, t≤10sec
- pulse test: pulse width≤300μs, duty≤2%
- guaranteed by design, not subject to production testing

**Thermal Characteristics**

Thermal Resistance junction-to ambient	Rth JA	100	°C/W
--	--------	-----	------

## Typical Performance Characteristics

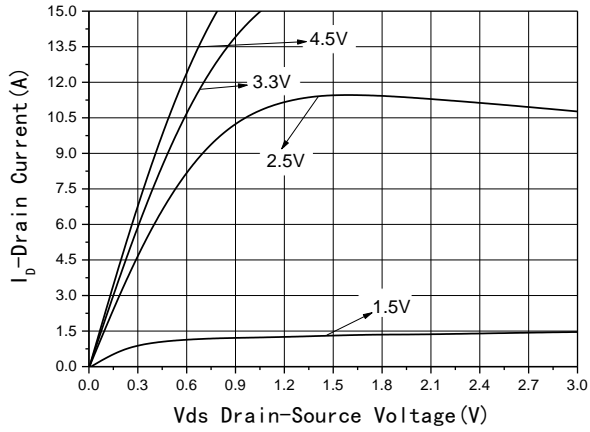

Fig1 Output Characteristics

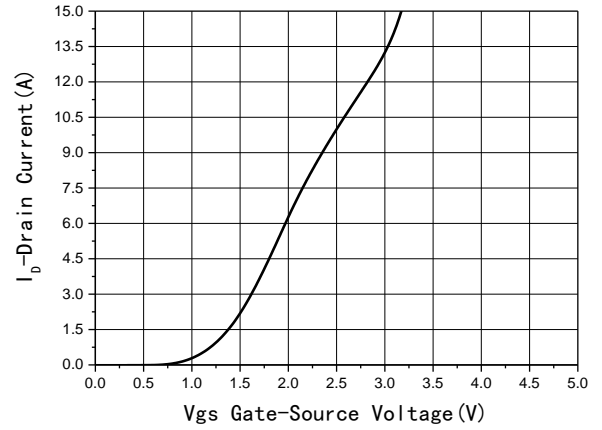

Fig2 Transfer Characteristics

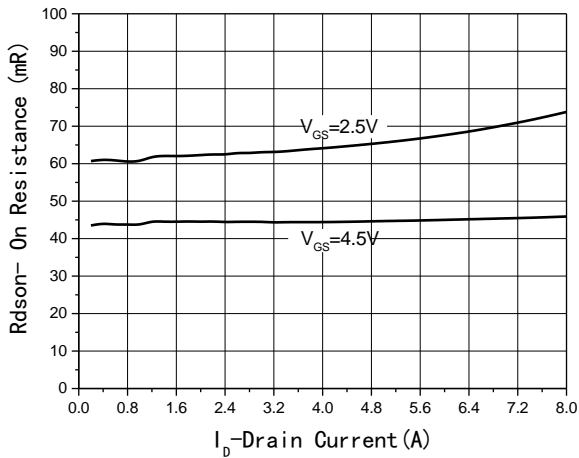

Fig3  $R_{DS(on)}$ -Drain current

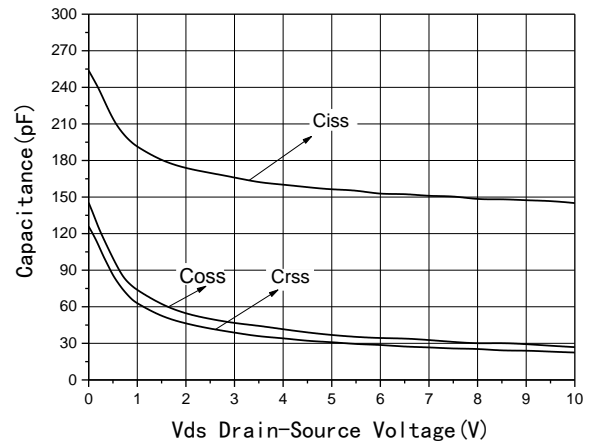

Fig4 Capacitance vs  $V_{DS}$

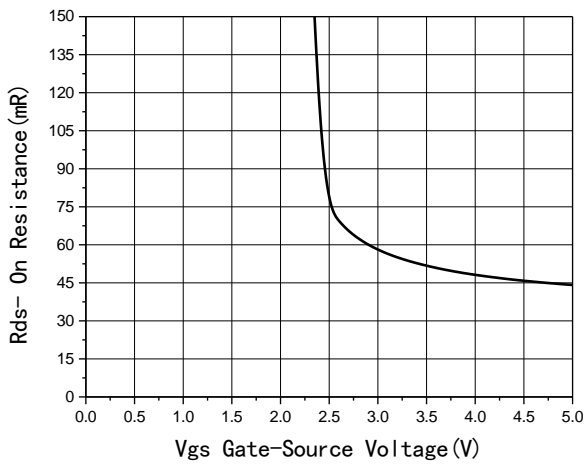

Fig5  $R_{DS(on)}$ -Gate Drain voltage

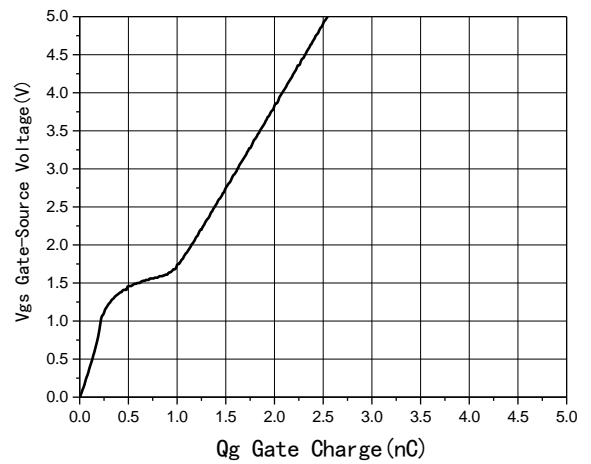
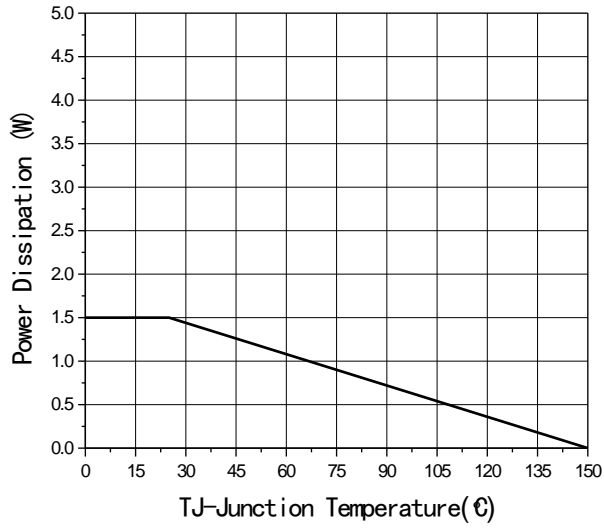
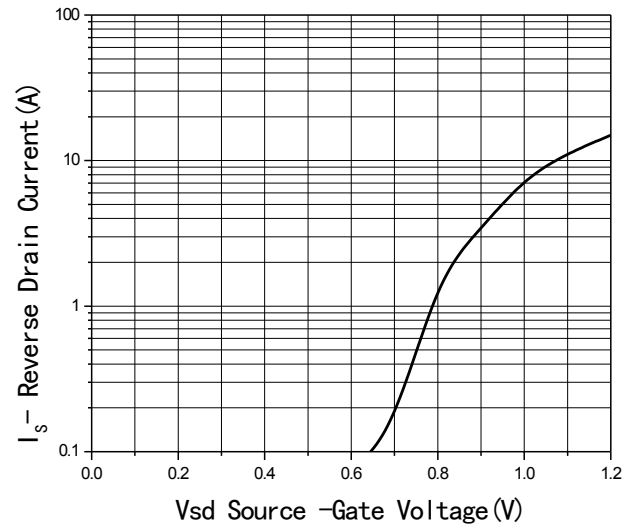

Fig6 Gate Charge



**Fig7 Power De-rating**



**Fig8 Source-Drain Diode Forward**

## Package Information

- ESOT-23-3L

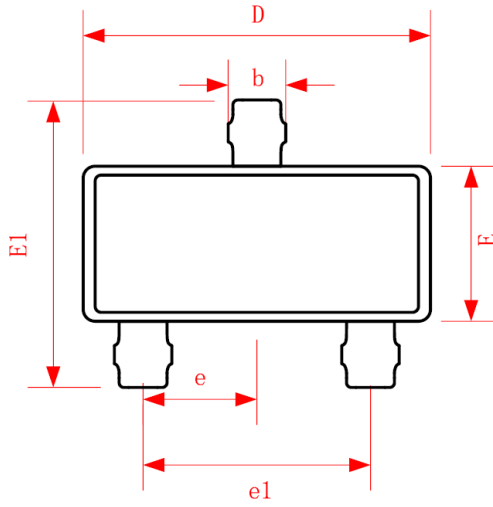

Top View  
【顶视图】

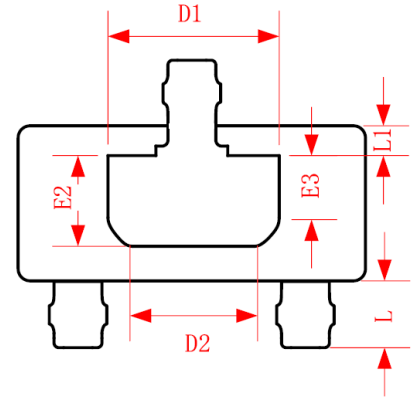

Bottom View  
【背视图】

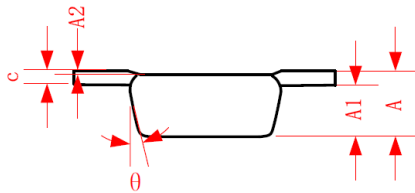

Side View  
【侧视图】

Symbol	Dimensions In Millimeters		
	Min.	REF.	Max.
A	0.500	0.550	0.600
A1	0.368	0.398	0.428
A2	-0.030	0.000	0.030
c	0.152Ref		
D	2.850	2.900	2.950
E	1.250	1.300	1.350
E1	2.350	2.400	2.450
D1	1.405	1.430	1.455
D2	0.995	1.020	1.045
E2	0.735	0.760	0.785
E3	0.490	0.520	0.545
L	0.525	0.550	0.575
L1	0.235	0.260	0.285
e	0.950Ref		
e1	1.800	1.900	2.000
b	0.410	0.480	0.550
$\theta$	14°	15°	16°