

Specification for Approval

Date: 2017/05/03

Customer : 深圳台慶

TAI-TECH P/N: TMPC1004H-series(G)-D

CUSTOMER P/N: _____

DESCRIPTION: _____

QUANTITY: _____ pcs

REMARK:		
Customer Approval Feedback		

西北臺慶科技股份有限公司
 TAI-TECH Advanced Electronics Co., Ltd
Headquarter:
 NO.1 YOU 4TH ROAD, YOUTH INDUSTRIAL DISTRICT, YANG-MEI,
 TAO-YUAN HSIEN, TAIWAN, R.O.C.
 TEL: +886-3-4641148 FAX: +886-3-4643565
 http://www.tai-tech.com.tw
 E-mail: sales@tai-tech.com.tw

Office:
 深圳辦公室
 11BC, Building B Fortune Plaza, NO.7002, Shennan Avenue, Futian
 District Shenzhen
 TEL: +86-755-23972371 FAX: +86-755-23972340

臺慶精密電子(昆山)有限公司
 TAI-TECH ADVANCED ELECTRONICS(KUNSHAN) CO., LTD
 SHINWHA ROAD, KUNJIA HI-TECH INDUSTRIAL PARK, KUN-SHAN,
 JIANG-SU, CHINA
 TEL: +86-512-57619396 FAX: +86-512-57619688
 E-mail: sales@tai-tech.cn

慶邦電子元器件(泗洪)有限公司
 TAIPAQ ELECTRONICS (SIHONG) CO., LTD
 JIN SHA JIANG ROAD , CONOMIC DEVELOPMENT ZONE SIHONG ,
 JIANGSU , CHINA.
 TEL: +86-527-88601191 FAX: +86-527-88601190
 E-mail: sales@taipaq.cn

Sales Dep.

APPROVED	CHECKED
曾詩涵 Angela Tseng	曾詩涵 Angela Tseng

R&D Center

APPROVED	CHECKED	DRAWN
羅宜春	梁周虎	張光

SMD Power Inductor

TMPC1004HV-Series(G)-D

1. Features

1. Carbonyl Powder.
2. Compact design.
3. High current · low DCR · high efficiency.
4. Very low acoustic noise and very low leakage flux noise.
5. High reliability.
6. 100% Lead(Pb)-Free and RoHS compliant.
7. High reliability -Reliability test complied to AEC-Q200.



2. Applications

Note PC power system · incl. IMVP-6
DC/DC converter .

3. Dimensions

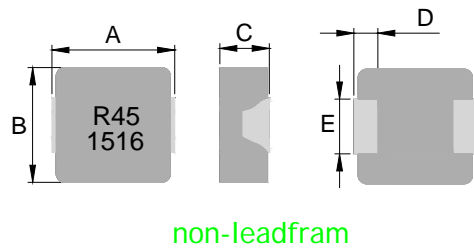
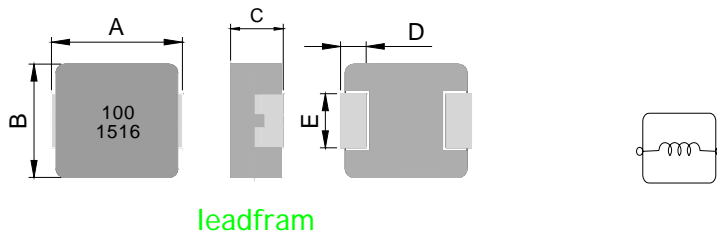

Recommend PC Board Pattern

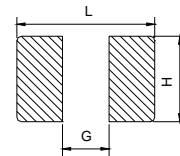

Series	Type	A(mm)	B(mm)	C(mm)	D(mm)	E(mm)
TMPC1004HV	leadfram	11.0±0.5	10.0±0.3	3.8±0.2	2.3±0.3	3.0±0.3
	non-leadfram					

L(mm)	G(mm)	H(mm)
13.6	5.4	3.5

Note: 1. The above PCB layout reference only.
2. Recommend solder paste thickness at 0.15mm and above.

4. Part Numbering

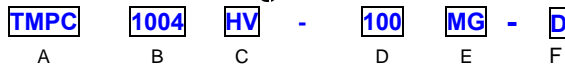

A: Series
B: Dimension
C: Type
D: Inductance
E: Inductance Tolerance
F: 印 D/C

BxC
Carbonyl Powder,vehicle.
100=10.0uH
M=±20%
印字:黑色.100 及 D/C 1516 (15 年,16 週期)(依實際生產日期而定)

5. Specification

Part Number	Inductance L0 (uH)±20% @ 0 A	I rms (A) Typ.	I sat (A) Typ.	DCR (mΩ) Typ. @25°C	DCR (mΩ) Max. @25°C	Type
TMPC1004HV-R15YG-D	0.15±30%	43	75	0.5	0.6	non-leadframe
TMPC1004HV-R19YG-D	0.19±30%	36	70	0.6	0.9	non-leadframe
TMPC1004H-R20YG-D	0.20±30%	35	70	0.66	0.95	non-leadframe
TMPC1004HV-R22MG-D	0.22	35	60	0.8	1.0	non-leadframe
TMPC1004HV-R24MG-D	0.24	34	60	0.8	1.0	non-leadframe
TMPC1004HV-R27MG-D	0.27	33	60	0.82	1.0	non-leadframe
TMPC1004HV-R30MG-D	0.30	32	60	0.94	1.1	non-leadframe
TMPC1004HV-R36MG-D	0.36	31	60	1.05	1.2	non-leadframe
TMPC1004HV-R39MG-D	0.39	30	60	1.1	1.3	non-leadframe
TMPC1004HV-R45MG-D	0.45	29	45	1.3	1.5	non-leadframe
TMPC1004HV-R47MG-D	0.47	28	43	1.3	1.5	non-leadframe
TMPC1004HV-R56MG-D	0.56	25	40	1.6	1.8	non-leadframe
TMPC1004HV-R68MG-D	0.68	22	39	2.4	2.7	non-leadframe
TMPC1004HV-R75MG-D	0.75	22	39	2.4	2.7	non-leadframe
TMPC1004HV-R88MG-D	0.88	20	38	2.5	2.9	non-leadframe
TMPC1004HV-R90MG-D	0.90	20	38	2.6	3.0	non-leadframe
TMPC1004HV-1R0MG-D	1.00	18	36	3.0	3.3	non-leadframe
TMPC1004HV-1R2MG-D	1.20	17	33	3.3	3.8	non-leadframe
TMPC1004HV-1R5MG-D	1.50	16	33	4.0	4.6	non-leadframe
TMPC1004HV-1R8MG-D	1.80	14	30	5.3	6.4	leadframe
TMPC1004HV-2R2MG-D	2.20	12	27	6.5	7.0	leadframe
TMPC1004HV-2R5MG-D	2.50	11.5	23	7.9	8.7	leadframe
TMPC1004HV-3R0MG-D	3.00	11.5	21	10	11.5	leadframe
TMPC1004HV-3R3MG-D	3.30	11	20	10.8	11.8	leadframe
TMPC1004HV-3R9MG-D	3.90	10.5	19	12.6	14.5	leadframe
TMPC1004HV-4R0MG-D	4.00	10.2	18	13	15	leadframe
TMPC1004HV-4R7MG-D	4.70	10	17	15.0	15.5	leadframe
TMPC1004HV-5R6MG-D	5.60	9.0	14	17	19.3	leadframe
TMPC1004HV-6R2MG-D	6.20	8.7	13.7	17.2	21.3	leadframe
TMPC1004HV-6R5MG-D	6.50	8.6	13.6	17.3	22.3	leadframe
TMPC1004HV-6R8MG-D	6.80	8.5	13.5	17.5	23.3	leadframe
TMPC1004HV-7R3MG-D	7.30	8.3	13.0	19.0	21.8	leadframe
TMPC1004HV-8R2MG-D	8.20	8.0	12.5	20	22.5	leadframe
TMPC1004HV-100MG-D	10.0	7.5	12.0	27.0	30	leadframe
TMPC1004HV-150MG-D	15.0	6.25	10	40	45	leadframe
TMPC1004HV-180MG-D	18.0	5.5	9.0	56	62	leadframe
TMPC1004HV-220MG-D	22.0	5.0	7.0	64	74	leadframe
TMPC1004HV-270MG-D	27.0	4.0	6.0	86	100	leadframe
TMPC1004HV-330MG-D	33.0	3.5	5.0	92	112	leadframe
TMPC1004HV-470MG-D	47.0	3.0	4.5	145	167	leadframe
TMPC1004HV-680MG-D	68.0	2.0	3.0	205	240	leadframe
TMPC1004HV-820MG-D	82.0	1.5	2.5	265	320	leadframe

Note:

1. Test frequency : Ls : 100KHz /1.0V.
2. All test data referenced to 25°C ambient.
3. Testing Instrument(or equ) : L: HP4284A,CH11025,CH3302,CH1320,CH1320S LCR METER / Rdc:CH16502,Agilent33420A MICRO OHMMETER.
4. Heat Rated Current (Irms) will cause the coil temperature rise approximately ΔT of 40°C
5. Saturation Current (Isat) will cause L0 to drop approximately 20%.
6. The part temperature (ambient + temp rise) should not exceed 125°C under worst case operating conditions.Circuit design,component,PCB trace size and thickness,airflow and other cooling provisions all affect the part temperature. Part temperature should be verified in the end application.
7. Special inquiries besides the above common used types can be met on your requirement.

6. Material List

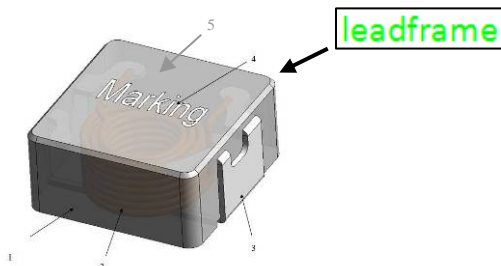

NO	Items	Materials
1	Core	Carbonyl Powder.
2	Wire	Polyester Wire or equivalent.
3	Clip	100% Pb free solder(Ni+Sn---Plating)
4	Ink	Halogen-free ketone
5	paint	Epoxy resin

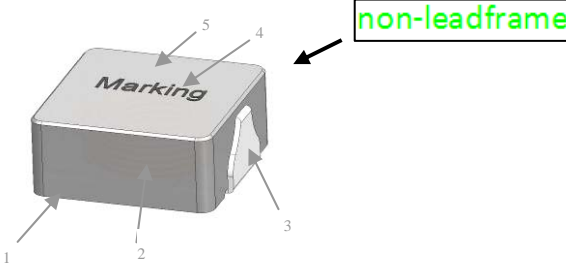

NO	Items	Materials
1	Core	Carbonyl Powder.
2	Wire	Polyester Wire or equivalent.
3	Solder	100% Pb free solder
4	Ink	Halogen-free ketone
5	paint	Epoxy resin

7. Reliability and Test Condition

Item	Performance	Test Condition
Operating temperature	-55~+125°C (Including self - temperature rise)	
Storage temperature and Humidity range	1.-10~+40°C,50~60%RH (Product without taping) 2.-55~+125°C (on board)	
Electrical Performance Test		
Inductance	Refer to standard electrical characteristics list.	HP4284A,CH11025,CH3302,CH1320,CH1320S LCR Meter.
DCR		CH16502,Agilent33420A Micro-Ohm Meter.
Saturation Current (Isat)	Approximately ΔL20%	Saturation DC Current (Isat) will cause L0 to drop ΔL(%)
Heat Rated Current (Irms)	Approximately ΔT40°C	Heat Rated Current (Irms) will cause the coil temperature rise ΔT(°C) without core loss. 1.Applied the allowed DC current. 2.Temperature measured by digital surface thermometer
Reliability Test		
High Temperature Exposure(Storage)	Appearance : No damage. Inductance : within±10% of initial value Q : Shall not exceed the specification value. RDC : within ±15% of initial value and shall not exceed the specification value	Preconditioning: Run through IR reflow for 2 times.(IPC/JEDEC J-STD-020DClassification Reflow Profiles Temperature : 125±2°C (Inductor) Duration : 1000hrs Min. Measured at room temperature after placing for 24±2 hrs
Temperature Cycling		Preconditioning: Run through IR reflow for 2 times.(IPC/JEDEC J-STD-020DClassification Reflow Profiles Condition for 1 cycle Step1 : -55±2°C 30min Min.(Inductor) Step2 : 125±2°C transition time 1min MAX. Step3 : 125±2°C 30min Min. Step4 : Low temp. transition time 1min MAX. Number of cycles : 1000 Measured at room temperature after placing for 24±2 hrs
Moisture Resistance		Preconditioning: Run through IR reflow for 2 times.(IPC/JEDEC J-STD-020DClassification Reflow Profiles 1. Baked at50°C for 25hrs, measured at room temperature after placing for 4 hrs. 2. Raise temperature to 65±2°C 90-100%RH in 2.5hrs, and keep 3 hours, cool down to 25°C in 2.5hrs. 3. Raise temperature to 65±2°C 90-100%RH in 2.5hrs, and keep 3 hours, cool down to 25°C in 2.5hrs,keep at 25°C for 2 hrs then keep at -10°C for 3 hrs 4. Keep at 25°C 80-100%RH for 15min and vibrate at the frequency of 10 to 55 Hz to 10 Hz, measure at room temperature after placing for 1~2 hrs.
Biased Humidity (AEC-Q200)		Preconditioning: Run through IR reflow for 2 times.(IPC/JEDEC J-STD-020DClassification Reflow Profiles Humidity : 85±3% R.H, Temperature : 85°C±2°C Duration : 1000hrs Min with 100% rated current. Measured at room temperature after placing for24±2 hrs
High Temperature Operational Life (AEC-Q200)		Preconditioning: Run through IR reflow for 2 times.(IPC/JEDEC J-STD-020DClassification Reflow Profiles Temperature : 125±2°C (Inductor) Duration : 1000hrs Min. with 100% rated current. Measured at room temperature after placing for24±2 hrs
Vibration		Oscillation Frequency: 10~2K~10Hz for 20 minute Equipment : Vibration checker Total Amplitude:1.52mm±10% Testing Time : 12 hours(20 minutes, 12 cycles each of 3 orientations) °

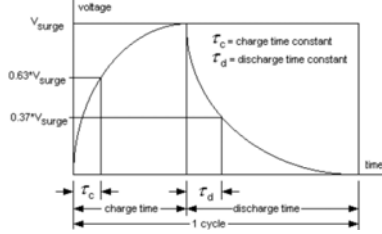
Item	Performance	Test Condition															
Mechanical Shock		<table border="1" data-bbox="975 237 1410 371"> <thead> <tr> <th>Type</th> <th>Peak value (g's)</th> <th>Normal duration (D) (ms)</th> <th>Wave form</th> <th>Velocity change (Vi)ft/sec</th> </tr> </thead> <tbody> <tr> <td>SMD</td> <td>100</td> <td>6</td> <td>Half-sine</td> <td>12.3</td> </tr> <tr> <td>Lead</td> <td>100</td> <td>6</td> <td>Half-sine</td> <td>12.3</td> </tr> </tbody> </table> <p>shocks in each direction along 3 perpendicular axes.</p>	Type	Peak value (g's)	Normal duration (D) (ms)	Wave form	Velocity change (Vi)ft/sec	SMD	100	6	Half-sine	12.3	Lead	100	6	Half-sine	12.3
Type	Peak value (g's)	Normal duration (D) (ms)	Wave form	Velocity change (Vi)ft/sec													
SMD	100	6	Half-sine	12.3													
Lead	100	6	Half-sine	12.3													
Resistance to Soldering Heat	Appearance : No damage. Impedance : within±15% of initial value Inductance : within±10% of initial value Q : Shall not exceed the specification value.	Number of heat cycles: 1 <table border="1" data-bbox="991 454 1390 533"> <thead> <tr> <th>Temperature(°C)</th> <th>Time(s)</th> <th>Temperature ramp/immersion and emersion rate</th> </tr> </thead> <tbody> <tr> <td>260±5(solder temp)</td> <td>10±1</td> <td>25mm/s ±6 mm/s</td> </tr> </tbody> </table>	Temperature(°C)	Time(s)	Temperature ramp/immersion and emersion rate	260±5(solder temp)	10±1	25mm/s ±6 mm/s									
Temperature(°C)	Time(s)	Temperature ramp/immersion and emersion rate															
260±5(solder temp)	10±1	25mm/s ±6 mm/s															
Thermal shock	RDC : within ±15% of initial value and shall not exceed the specification value	Preconditioning: Run through IR reflow for 2 times.(IPC/JEDEC J-STD-020DClassification Reflow Profiles Condition for 1 cycle Step1 : -55±2°C 15±1min(Inductor) Step2 : 125±2°C within 20Sec. Step3 : 125±2°C 15±1min Number of cycles : 300 Measured at room temperature after placing fo24±2hrs															
Resistance to Solvents	Appearance : No damage.	Add aqueous wash chemical - OKEM clean or equivalent.															
ESD		 <p>The diagram shows a voltage surge waveform. The y-axis is labeled 'voltage' and has markers for V_{surge}, $0.63 \cdot V_{surge}$, and $0.37 \cdot V_{surge}$. The x-axis is labeled 'time' and shows 'charge time' and 'discharge time'. The charge time constant is labeled τ_c and the discharge time constant is labeled τ_d. A '1 cycle' duration is indicated at the bottom.</p>															
Solderability	More than 95% of the terminal electrode should be covered with solder ◦	Steam Aging: 8 hours ± 15 min Preheat: 150°C, 60sec. ◦ Solder: Sn96.5%, Ag3% Cu0.5% Temperature: 245±5°C ◦ Flux for lead free: Rosin. 9.5% ◦ Dip time: 4±1sec. Depth: completely cover the termination															
Flammability	Electrical Test not required epoxy	V-0 or V-1 are acceptable V-0 or V-1 are acceptable															

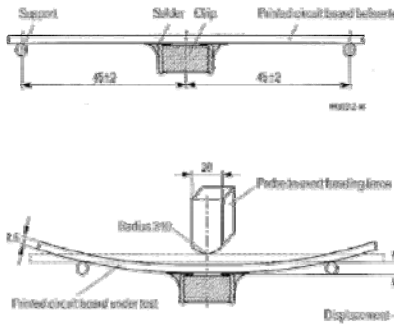
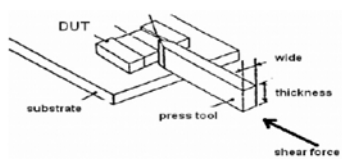
Item	Performance	Test Condition
Board Flex	Appearance : No damage.	<p>Preconditioning: Run through IR reflow for 2 times.(IPC/JEDEC J-STD-020D Classification Reflow Profiles Place the 100mm X 40mm board into a fixture similar to the one shown in below Figure with the component facing down. The apparatus shall consist of mechanical means to apply a force which will bend the board (D) x = 2 mm minimum. The duration of the applied forces shall be 60 (+ 5) sec. The force is to be applied only once to the board.</p> 
Terminal Strength (SMD)		<p>Preconditioning: Run through IR reflow for 2 times.(IPC/JEDEC J-STD-020D Classification Reflow Profiles With the component mounted on a PCB with the device to be tested, apply a 17.7 N (1.8 Kg) force to the side of a device being tested. This force shall be applied for 60 +1 seconds. Also the force shall be applied gradually as not to apply a shock to the component being tested.</p> 

Note : When there are questions concerning measurement result : measurement shall be made after 48 ± 2 hours of recovery under the standard condition.

8. Soldering and Mounting

(1) Soldering

Mildly activated rosin fluxes are preferred. The minimum amount of solder can lead to damage from the stresses caused by the difference in coefficients of expansion between solder, chip and substrate. TAI-TECH terminations are suitable for re-flow soldering systems. If hand soldering cannot be avoided, the preferred technique is the utilization of hot air soldering tools.

(2) Solder re-flow:

Recommended temperature profiles for re-flow soldering in Figure 1.

(3) Soldering Iron:

Products attachment with a soldering iron is discouraged due to the inherent process control limitations. In the event that a soldering iron must be employed the following precautions are recommended.

- Preheat circuit and products to 150°C
- Never contact the ceramic with the iron tip
- Use a 20 watt soldering iron with tip diameter of 1.0mm
- 355°C tip temperature (max)
- 1.0mm tip diameter (max)
- Limit soldering time to 4-5sec.

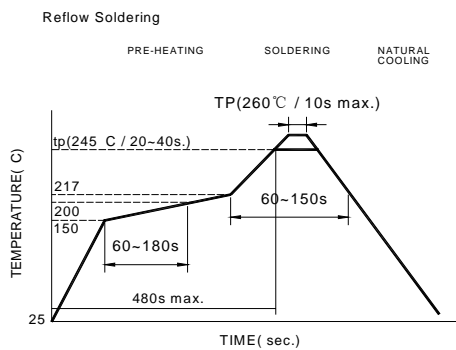

Reflow times: 3 times max.

Fig.1

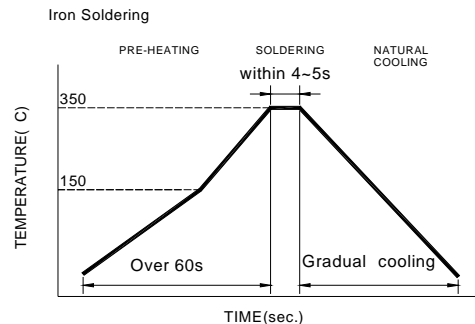

Iron Soldering times: 1 times max.

Fig.2

9. Packaging Information

(1) Reel Dimension

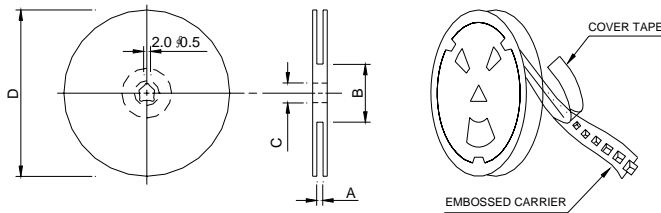

Type	A(mm)	B(mm)	C(mm)	D(mm)
13"x24mm	24.4+2/-0	100±2	13+0.5/-0.2	330

(2) Tape Dimension

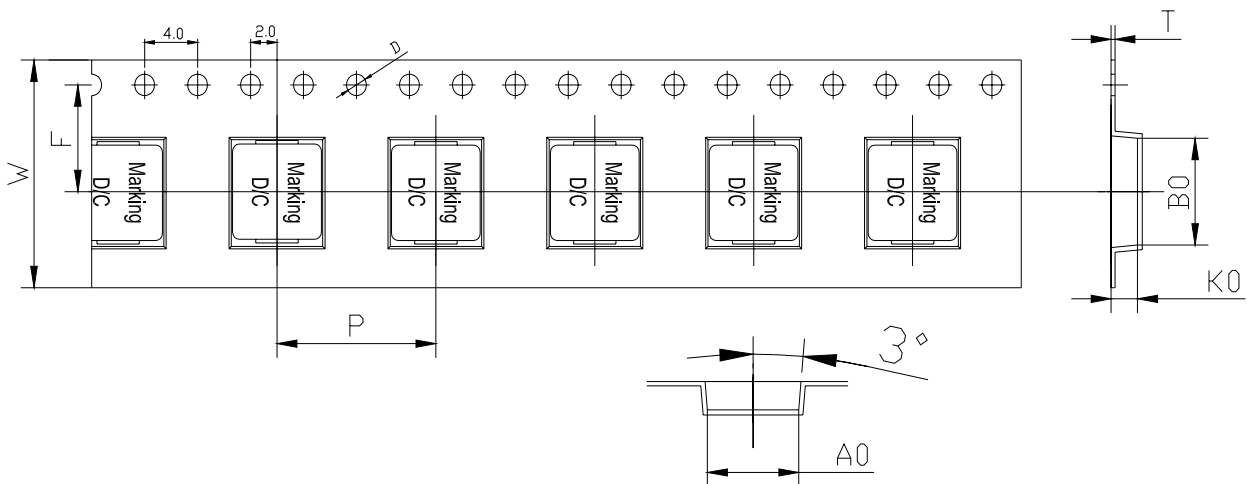

Series	Size	Bo(mm)	Ao(mm)	Ko(mm)	P(mm)	W(mm)	F(mm)	t(mm)	D(mm)
TMPC	1004	11.6±0.1	10.4±0.1	4.5±0.1	16.0±0.1	24±0.3	11.5±0.1	0.35±0.05	1.5±0.1

(3) Packaging Quantity

TMPC	1004
Chip / Reel	500
Inner box	1000
Carton	4000

(4) Tearing Off Force

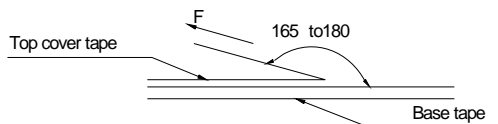

The force for tearing off cover tape is 10 to 130 grams in the arrow direction under the following conditions(referenced ANSI/EIA-481-C-2003 of 4.11 stadnard).

Room Temp. (°C)	Room Humidity (%)	Room atm (hPa)	Tearing Speed mm/min
5~35	45~85	860~1060	300

Application Notice

- Storage Conditions
 - To maintain the solderability of terminal electrodes:
 - TAIPAQ products meet IPC/JEDEC J-STD-020D standard-MSL, level 1.
 - Temperature and humidity conditions: Less than 40°C and 60% RH.
 - Recommended products should be used within 12 months form the time of delivery.
 - The packaging material should be kept where no chlorine or sulfur exists in the air.
- Transportation
 - Products should be handled with care to avoid damage or contamination from perspiration and skin oils.
 - The use of tweezers or vacuum pick up is strongly recommended for individual components.
 - Bulk handling should ensure that abrasion and mechanical shock are minimized.

10. Typical Performance Curves

