

SPECIFICATIONS

Customer	
Product Name	Wire Wound SMD Type Power Inductors
Sunlord Part Number	SWCC Series
Customer Part Number	

New Released, Revised]

SPEC No.: SWCC07180000

【This SPEC is total 11 pages including specifications and appendix.】

【ROHS Compliant Parts】

Approved By	Checked By	Issued By

Shenzhen Sunlord Electronics Co., Ltd.

Address: Sunlord Industrial Park, Dafuyuan Industrial Zone, Guanlan, Shenzhen, China 518110
 Tel: 0086-755-29832660 Fax: 0086-755-82269029 E-Mail: sunlord@sunlordinc.com

【For Customer approval Only】

Date: _____

Qualification Status: Full Restricted Rejected

Approved By	Verified By	Re-checked By	Checked By

Comments:

【Version change history】

Rev.	Effective Date	Changed Contents	Change Reasons	Approved By
01	/	New release	/	Simei Yu

【Precautions】

- (1) Magnetic materials shall be far away from parts to avoid impacts on their electrical characteristics.
- (2) Parts could be damaged by external mechanical pressure or stacked heavy objects, as well as strong shaking & dropping.
- (3) Please do not store parts in bulk to prevent coils and parts being damaged.
- (4) When parts are installed, pressure put on Core shall be no more than 5N. Otherwise, the Core would be damaged or cracked.
- (5) Oversized external force to parts on PCB may lead to parts being damaged or slipped off.
- (6) Please do not use parts on edge or top of PCB board in your design to avoid parts being damaged during PCB is moved.

Caution:

All products listed in this specification are developed, designed and intended for use in general electronics equipment. The products are not designed or warranted to meet the requirements of the applications listed below, whose performance and/or quality require especially high reliability, or whose failure, malfunction or trouble might directly cause damage to society, person, or property. Please understand that we are not responsible for any damage or liability caused by use of the products in any of the applications below. Please contact us for more details if you intend to use our products in the following applications.

1. Aircraft equipment
2. Aerospace equipment
3. Undersea equipment
4. nuclear control equipment
5. military equipment
6. Power plant equipment
7. Medical equipment
8. Transportation equipment (automobiles, trains, ships, etc.)
9. Traffic signal equipment
10. Disaster prevention / crime prevention equipment
11. Data-processing equipment
12. Applications of similar complexity or with reliability requirements comparable to the applications listed in the above

1. Scope

This specification applies to SWCC series of wire wound SMD type power inductors

2. Product Description and Identification (Part Number)

1) Description

Wire Wound SMD Type Power Inductor, SWCCXXXX, XX $\mu\text{H} \pm X\%$ @XXX KHz/XXXV, XXX Ω , XXXm A.

2) Product Identification (Part Number)

SWCC XXXX -XXX □ I
 ① ② ③ ④ ⑤

①	Type
SWCC	Wire Wound SMD Type Power Inductors (With Ceramic Base)

②	External Dimensions (L X H) (mm)
	0603

③	Nominal Inductance
Example	Nominal Value
2R2	2.2 μH
680	68 μH

④	Inductance Tolerance
M	$\pm 20\%$
N	$\pm 30\%$

⑤	Packing
T	Tape Carrier Package

3. Electrical Characteristics

- 1) Operating and storage temperature range (individual chip without packing): **-40°C to +105°C**
- 2) Storage temperature range (packaging conditions): -10°C~+40°C and RH 70% (Max.)

4. Shape and Dimensions

1) Dimensions and recommended PCB pattern for reflow soldering: See Fig.4-1, Fig.4-2 and Table 4-1.

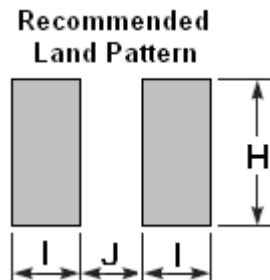
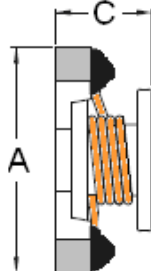
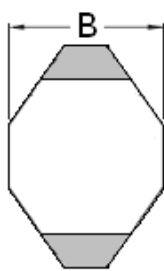

Fig. 4-1

Fig. 4-2

[Table 4-1]

Unit: mm

Series	A max.	B max.	C max.	I typ.	J typ.	H typ.
SWCC0603	6.8	4.5	3.0	1.2	4.0	2.5

2) Structure and Components: See Table 4-2

[Table 4-2]

Symbol	Components	Material
A	MARK	Ink
B	DRUM CORE	Ferrite
C	WIRE	Polyurethane copper wire
D	GLUE	Epoxy resin
E	BASE	Ceramic
F	ELECTRODE	Ceramic plated with Tin

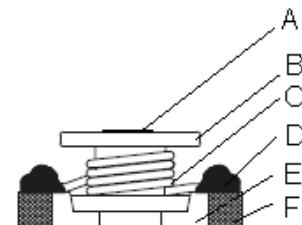

5. Electrical Characteristics

SWCC0603 TYPE

Part Number	Inductance	L Test Condition	Max. DC Resistance	Max. Saturation Current	Max. Heat Rating Current
Units	μH	Hz, V	Ω	A	A
Symbol	L	-	DCR	I _{sat}	I _{rms}
SWCC0603-1R0NT	1.0±30%	100K, 0.3V	0.05	2.9	2.9
SWCC0603-1R5NT	1.5±30%	100K, 0.3V	0.06	2.6	2.8
SWCC0603-2R2NT	2.2±30%	100K, 0.3V	0.070	2.40	2.30
SWCC0603-3R3NT	3.3±30%	100K, 0.3V	0.080	2.00	2.00
SWCC0603-4R7NT	4.7±30%	100K, 0.3V	0.090	1.50	1.50
SWCC0603-6R8NT	6.8±30%	100K, 0.3V	0.130	1.40	1.20
SWCC0603-8R2NT	8.2±30%	100K, 0.3V	0.145	1.30	1.15
SWCC0603-100MT	10±20%	1k, 0.3V	0.160	1.20	1.10
SWCC0603-150MT	15±20%	1k, 0.3V	0.230	1.10	0.90
SWCC0603-220MT	22±20%	1k, 0.3V	0.370	0.80	0.70
SWCC0603-330MT	33±20%	1k, 0.3V	0.510	0.60	0.58
SWCC0603-470MT	47±20%	1k, 0.3V	0.640	0.50	0.50
SWCC0603-680MT	68±20%	1k, 0.3V	0.980	0.40	0.40

6. Test and Measurement Procedures

6.1 Test Conditions

6.1.1 Unless otherwise specified, the standard atmospheric conditions for measurement/test as:

- Ambient Temperature: 20±15℃
- Relative Humidity: 65±20%
- Air Pressure: 86 KPa to 106 KPa

6.1.2 If any doubt on the results, measurements/tests should be made within the following limits:

- Ambient Temperature: 20±2℃
- Relative Humidity: 65±5%
- Air Pressure: 86KPa to 106 KPa

6.2 Visual Examination

- Inspection Equipment: 10 X magnifier

6.3 Electrical Test

6.3.1 DC Resistance (DCR)

- Refer to **Item 5**.
- Test equipment (Analyzer): HIOKI3540 or equivalent.

6.3.2 Inductance (L)

- Refer to **Item 5**.
- Test equipment: Wayne kerr3260+3265B or equivalent.

6.3.3 Rated Current

- Refer to **Item 5**.
- Test equipment: Wayne kerr3260+3265B, Agilent E3633A, R2M-2H3 or equivalent..
- Definition of Rated Current (I_r): With the condition of the DC current pass, the inductance decrease by **25%** of the standard value, compare to the temperature rise by **40℃**, the smaller is Rated Current.(reference environment temperature:20℃)

6.4 Reliability Test

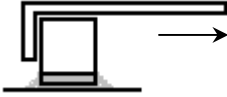
Item	Requirements	Test Methods and Remarks
6.4.1 Terminal Strength	No removal or split of the termination or other defects shall occur.	<ol style="list-style-type: none"> Apply pull force to axis direction. Applied force: 10 N. Keep time: 10±1s 

6.4.2 Vibration	① No visible mechanical damage. ② Inductance change: within $\pm 5\%$.	① The test samples shall be soldered to the board. Then it shall be submitted to below test conditions. <table border="1" data-bbox="884 174 1430 371"> <tr> <td>Fre. Range</td> <td>10~55Hz</td> </tr> <tr> <td>Total Amplitude</td> <td>1.5mm(May not exceed acceleration 196 m/s^2)</td> </tr> <tr> <td>Sweeping Method</td> <td>10Hz to 55Hz to 10Hz for 1 min.</td> </tr> <tr> <td>Time</td> <td>For 2 hours on each X,Y,Z axis.</td> </tr> </table> ② Recovery: At least 2 hours of recovery under the standard condition after the test, followed by the measurement within 24 hours.	Fre. Range	10~55Hz	Total Amplitude	1.5mm(May not exceed acceleration 196 m/s^2)	Sweeping Method	10Hz to 55Hz to 10Hz for 1 min.	Time	For 2 hours on each X,Y,Z axis.
Fre. Range	10~55Hz									
Total Amplitude	1.5mm(May not exceed acceleration 196 m/s^2)									
Sweeping Method	10Hz to 55Hz to 10Hz for 1 min.									
Time	For 2 hours on each X,Y,Z axis.									
6.4.3 Temperature Characteristic	Inductance change: within $\pm 10\%$.	① Between -25°C and $+105^\circ\text{C}$ ② with a reference value of $+20^\circ\text{C}$								
6.4.4 Solderability	90% or more of mounting terminal side shall be covered with fresh solder.	① Solder Temperature: $240\pm 5^\circ\text{C}$ ② Keep time: $3\pm 0.5\text{s}$ ③ Immersion depth: from the main body to 1.5mm								

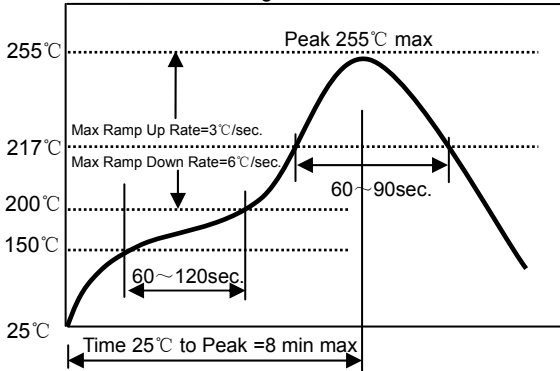
<p>6.4.5 Resistance to Soldering Heat</p>	<p>① No visible mechanical damage. ② Inductance change: within $\pm 10\%$.</p>	<p>① Re-flowing Profile: Please refer to lower tracing. ② Test board thickness: 1.0mm ③ Test board material: glass epoxy resin ④ The chip shall be stabilized at normal condition for 1~2 hours before measuring</p> 									
<p>6.4.6 Thermal Shock</p>	<p>① No visible mechanical damage. ② Inductance change: within $\pm 10\%$.</p>	<p>① The test samples shall be placed at specified temperature for specified time by step 1 to step 2 as shown in below table in sequence.</p> <table border="1" data-bbox="884 792 1431 920"> <thead> <tr> <th>Step</th> <th>Temperature(°C)</th> <th>Duration(min)</th> </tr> </thead> <tbody> <tr> <td>1</td> <td>-25</td> <td>30\pm3</td> </tr> <tr> <td>2</td> <td>+105</td> <td>30\pm3</td> </tr> </tbody> </table> <p>② Transforming interval: Max.20 sec ③ Test cycle: 10cycles. ④ Recovery: At least 2 hours of recovery under the standard condition after the test , followed by the measurement within 24 hours.</p>	Step	Temperature(°C)	Duration(min)	1	-25	30 \pm 3	2	+105	30 \pm 3
Step	Temperature(°C)	Duration(min)									
1	-25	30 \pm 3									
2	+105	30 \pm 3									
<p>6.4.7 Resistance to Low Temperature</p>	<p>① No visible mechanical damage. ② Inductance change: within $\pm 10\%$.</p>	<p>① The test samples shall be submitted to below test conditions.</p> <table border="1" data-bbox="884 1146 1342 1214"> <tbody> <tr> <td>Temperature</td> <td>-40\pm3°C</td> </tr> <tr> <td>Time</td> <td>500\pm24hour</td> </tr> </tbody> </table> <p>② Recovery: At least 2 hours of recovery under the standard condition after the test, followed by the measurement within 24 hours.</p>	Temperature	-40 \pm 3°C	Time	500 \pm 24hour					
Temperature	-40 \pm 3°C										
Time	500 \pm 24hour										
<p>6.4.8 Loading Under Damp Heat</p>	<p>① No visible mechanical damage. ② Inductance change: within $\pm 10\%$.</p>	<p>① The test samples shall be submitted to below test conditions.</p> <table border="1" data-bbox="884 1386 1342 1520"> <tbody> <tr> <td>Temperature</td> <td>60\pm2°C</td> </tr> <tr> <td>Humidity</td> <td>90~95%RH</td> </tr> <tr> <td>Applied current</td> <td>Rated current</td> </tr> <tr> <td>Time</td> <td>500\pm24hour</td> </tr> </tbody> </table> <p>② Recovery: At least 2 hours of recovery under the standard condition after the test , followed by the measurement within 24 hours.</p>	Temperature	60 \pm 2°C	Humidity	90~95%RH	Applied current	Rated current	Time	500 \pm 24hour	
Temperature	60 \pm 2°C										
Humidity	90~95%RH										
Applied current	Rated current										
Time	500 \pm 24hour										
<p>6.4.9 Resistance to High Temperature</p>	<p>① No visible mechanical damage. ② Inductance change: within $\pm 10\%$.</p>	<p>① The test samples shall be submitted to below test conditions.</p> <table border="1" data-bbox="884 1697 1342 1765"> <tbody> <tr> <td>Temperature</td> <td>105\pm3°C</td> </tr> <tr> <td>Time</td> <td>500\pm24hour</td> </tr> </tbody> </table> <p>② Recovery: At least 2 hours of recovery under the standard condition after the test , followed by the measurement within 24 hours.</p>	Temperature	105 \pm 3°C	Time	500 \pm 24hour					
Temperature	105 \pm 3°C										
Time	500 \pm 24hour										
<p>6.4.10 Loading at High Temperature (Life Test)</p>	<p>① No visible mechanical damage. ② Inductance change: within $\pm 10\%$.</p>	<p>① The test samples shall be submitted to below test conditions.</p> <table border="1" data-bbox="884 1935 1342 2033"> <tbody> <tr> <td>Temperature</td> <td>85\pm3°C</td> </tr> <tr> <td>Applied current</td> <td>Rated current</td> </tr> <tr> <td>Time</td> <td>500\pm24hour</td> </tr> </tbody> </table> <p>② Recovery: At least 2 hours of recovery under the standard condition after the test , followed by the measurement within 24 hours.</p>	Temperature	85 \pm 3°C	Applied current	Rated current	Time	500 \pm 24hour			
Temperature	85 \pm 3°C										
Applied current	Rated current										
Time	500 \pm 24hour										

7. Packaging

7.1 Tape Carrier Packaging:

Packaging code: T

- (1) Tape carrier packaging are specified in attached figure Fig.7.1-1~2
- (2) Tape carrier packaging quantity:

Type	SWCC0603
Quantity(Pcs/Reel)	2000

a. Taping Drawings (Unit: mm)

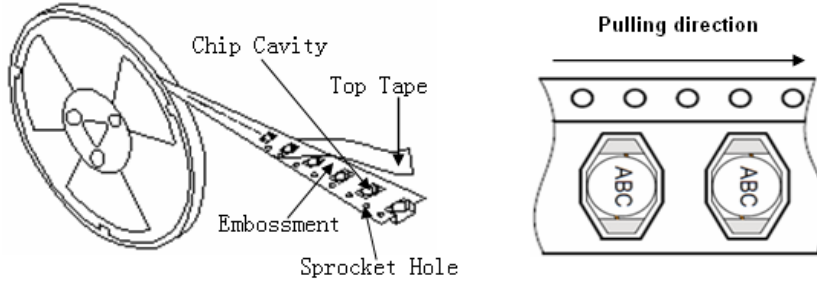

Fig.7.1-1

b. Reel and Taping Dimensions (Unit: mm)

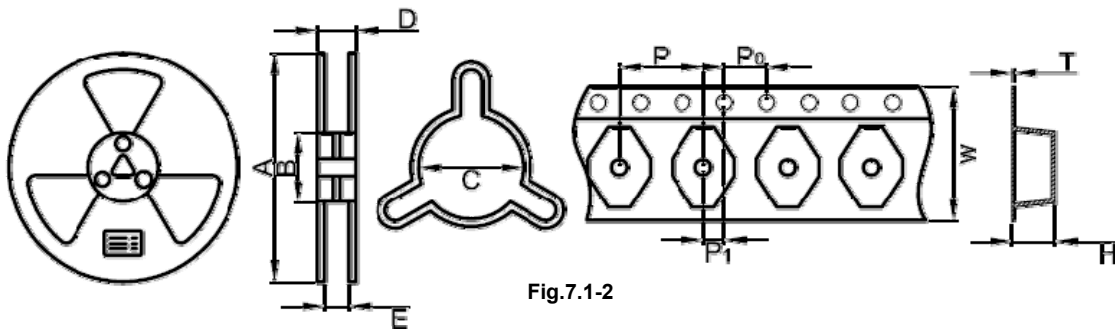

Fig.7.1-2

Type	Reel dimensions (mm)					Tape dimensions (mm)					
	A	B	C	D	E	W	P	P0	P1	H	T
SWCC0603	330	100	13	22.5	16.5	16.0	8.0	4.0	2.0	3.1	0.35

c. Peeling off force: 10gf to 130gf in the direction show below.

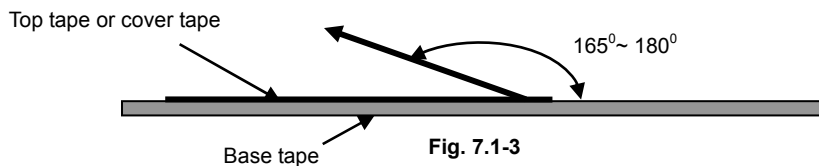

Fig. 7.1-3

7.2 Storage

- (1) The solderability of the external electrodes may deteriorate if packages are stored in high humidity. Besides, to ensure packing material's good state, packages must be stored at -10°C to 40°C and 70% RH Max.
- (2) The solderability of the external electrodes may deteriorate if packages are exposed to dust or harmful gas (e.g. HCl, sulfurous gas of H₂S).
- (3) Packaging materials may deform if packages are exposed directly to sunlight.
- (4) Minimum packages, such as polyvinyl heat-seal packages shall not be opened until they are used. If opened, use the reels as soon as possible.
- (5) Solderability shall be guaranteed for a period of time from the date of delivery on condition that they are stored at the specified environment. For those parts, which passed more than the time shall be checked solderability before using.
- (6) For magnetic products, keep clear of anything that may generate magnetic fields to avoid change of products performance.
- (7) To avoid any damage to products, do not load mechanic force on products or place heavy goods on products, and exclude strong vibration or drop.
- (8) In case of storage over 12 months, solderability shall be checked before actual usage.

8. Warning and Attention

8.1 Precautions on Use

- (1) Always wear static control bands to protect against ESD.
- (2) Any devices used with the products (soldering irons, measuring instruments) should be properly grounded.
- (3) Keep bare hands and metal conductors (i.e., metal desk) away from electrodes or conductive areas that lead to electrodes.
- (4) Preheat when soldering.
- (5) Don't apply current in excess of the rated current value. It may reduce the impedance or inductance, or cause damage to components due to over-current.
- (6) For magnetic products, keep clear of anything that may generate magnetic fields such as speakers and coils. Use non-magnetic tweezers when handling the chips.
- (7) When soldering, the electrical characteristics may be varied due to hot energy and mechanical stress.
- (8) When coating products with resin, the relatively high resin curing stress may change the electrical characteristics. For exterior coating, select resin carefully so that electrical and mechanical performance of the product is not affected. Before using, please evaluate reliability with the product mounted in your application set.
- (9) When mount chips with adhesive in preliminary assembly, do appropriate check before the soldering stage, i.e., the size of land pattern, type of adhesive, amount applied, hardening of the adhesive on proper usage and amounts of adhesive to use.
- (10) Mounting density: Add special attention to radiating heat of products when mounting other components nearby. The excessive heat by other products may cause deterioration at joint of this product with substrate.
- (11) Since some products are constructed like an open magnetic circuit, narrow spacing between components may cause magnetic coupling.
- (12) Please do not give the product any excessive mechanical shocks in transportation.
- (13) Please do not touch wires by sharp terminals such as tweezers to avoid causing any damage to wires.
- (14) Please do not add any shock and power to the soldered product to avoid causing any damage to chip body.
- (15) Please do not touch the electrodes by naked hand as the solderability of the external electrodes may deteriorate by grease or oil on the skin.

8.2 PCB Bending Design

The following shall be considered when designing and laying out PCB's.

- (1) PCB shall be designed so that products are not subjected to the mechanical stress from board warp or deflection.

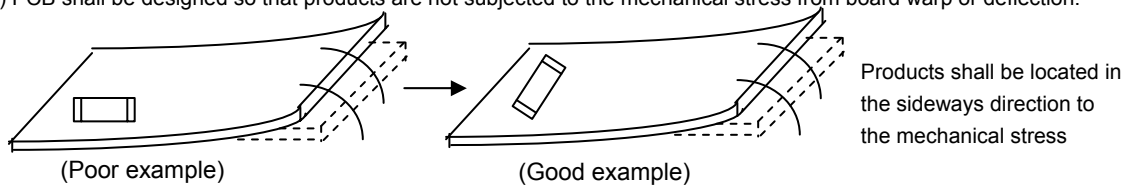

- (2) Products location on PCB separation.

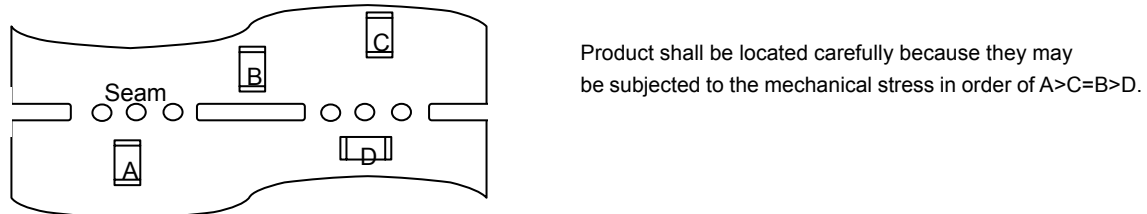

- (3) When splitting the PCB board, or insert (remove) connector, or fasten thread after mounting components, care is required so as not to give any stress of deflection or twisting to the board. Because mechanical force may cause deterioration of the bonding strength of electrode and solder, even crack of product body. Board separation should not be done manually, but by using appropriate devices.

8.3 Recommended PCB Design for SMT Land-Patterns

When chips are mounted on a PCB, the amount of solder used (size of fillet) can directly affect chip performance. Therefore, the following items must be carefully considered in the design of solder land patterns:

- (1) The amount of solder applied can affect the ability of chips to withstand mechanical stresses which may lead to breaking or cracking. Therefore, when designing land-patterns it is necessary to consider the appropriate size and configuration of the solder pads which in turn determines the amount of solder necessary to form the fillets.
- (2) When more than one part is jointly soldered onto the same land or pad, the pad must be designed that each component's soldering point is separated by solder-resist.

Recommended land dimensions please refer to product specification.

9. Recommended Soldering Technologies

9.1 Re-flowing Profile:

- △ Preheat condition: 150 ~200°C/60~120sec.
- △ Allowed time above 217°C: 60~90sec.
- △ Max temp: 255°C
- △ Max time at max temp: 10sec.
- △ Solder paste: Sn/3.0Ag/0.5Cu
- △ Allowed Reflow time: 2x max

Please refer to **Fig. 9.1**

[Note: The reflow profile in the above table is only for qualification and is not meant to specify board assembly profiles. Actual board assembly profiles must be based on the customer's specific board design, solder paste and process, and should not exceed the parameters as the Reflow profile shows.]

9.2 Iron Soldering Profile

- △ Iron soldering power: Max. 30W
- △ Pre-heating: 150°C/60sec.
- △ Soldering Tip temperature: 350°C Max.
- △ Soldering time: 3sec. Max.
- △ Solder paste: Sn/3.0Ag/0.5Cu
- △ Max.1 times for iron soldering

Please refer to **Fig.9.2**.

[Note: Take care not to apply the tip of the soldering iron to the terminal electrodes.]

9.3 Recommended Soldering Technologies

Heat Gun Profile

- △ Soldering tip temperature: 350°C Max.
- △ Hot air time: <5sec (over 5sec may cause wiring inductor short)
- △ When repairing or reworking the component near inductors, take over-heat protection for Inductors

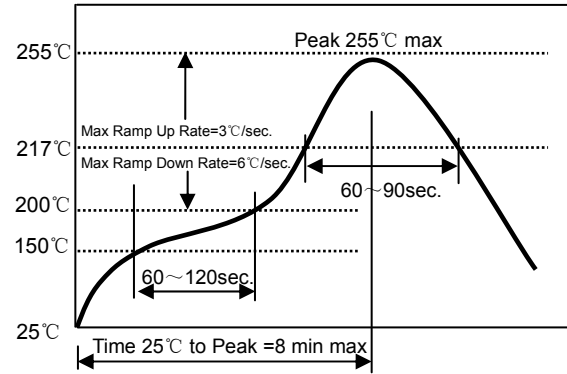

Fig. 9.1

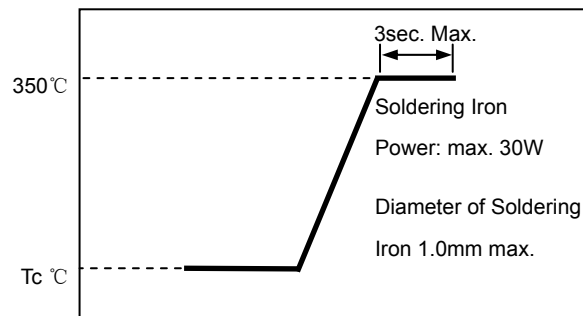
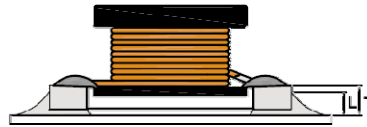

Fig. 9.2

10. Solder Volume

Solder shall be used not to exceed as shown below. Exceeding solder volume may cause the failure of mechanical or electrical performance.



$$0 \leq L \leq T$$

(T: height of electrode)

11. Cleaning

Products shall be cleaned on the following conditions:

- (1) Cleaning temperature shall be limited to 60°C Max. (40°C Max. for fluoride and alcohol type cleaner.)
- (2) Ultrasonic cleaning shall comply with the following conditions, avoiding the resonance phenomenon at the mounted products and PCB.

Power: 20W/l Max.

Frequency: 28 KHz to 40 KHz

Time: 5 minutes Max

Notice: Wire wound products do not recommend for ultrasonic cleaning.

(3) Cleaner

a Alternative cleaner

Isopropyl alcohol (IPA)

HCFC-225

b Aqueous agent

Surface Active Agent Type (Clean through-750H)

Hydrocarbon Type (Techno Cleaner-335)

Higher Alcohol Type (Pine Alpha ST-100S)

Alkali saponifier Type (※ Aqua Cleaner 240)

※ Alkali saponification shall be diluted to 20% volume with de-ionized water.





※ Please contact us before using other cleaner.

- (4) There shall be no residual flux and residual cleaner after cleaning. In the case of using aqueous agent, product shall be dried completely after rinse with de-ionized water in order to remove the cleaner.
- (5) Some products may become slightly whitened. However, product performance or usage is not affected.

12. Supplier Information

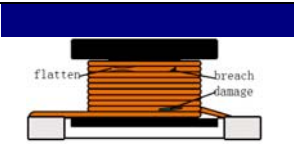
- a) Supplier:
Shenzhen Sunlord Electronics Co., Ltd.
- b) Manufacturer:
Shenzhen Sunlord Electronics Co., Ltd.
- c) Manufacturing Address:
Sunlord Industrial Park, Dafuyuan Industrial Zone, Guanlan, Shenzhen, China
Zip: 518110

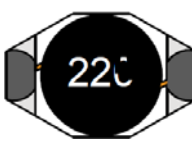
Visual inspection standard of product

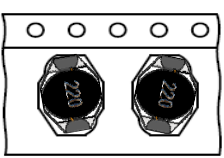
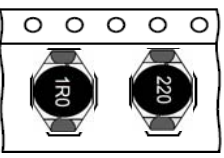
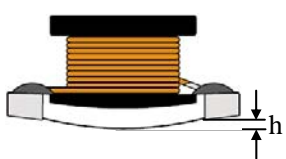
File No:		Applied to Wire Wound SMD Power Inductor Series	
Effective date:			
No.	Defect Item	Graphic	Rejection identification
1	Line damage		Enamelled copper wire (with the exception of a solder joint), injury, crushing, bending deformation, or other causes of copper wire bare, reduced cross sectional area defects
2	Wire fracture		Enamelled copper wire is broken
3	Printing defects		Printing defect, can not be correctly identified
4	Core chipping		1)length $\geq 1/8$ Upper swing diameter or depth $\geq 1/5$ Placed on the thickness 2)width $\geq 1/10$ Upper swing diameter or depth $\geq 1/5$ Placed on the thickness
5	Tape card feeding		Products in the carrier tape to shake
6	Mixed material		Different models of product mix
7	Electrode uneven		Single or two electrodes is localized in the same plane, height difference $h > 0.1\text{mm}$