

# Complementary Plastic Power Transistors

## NPN/PNP Silicon DPAK For Surface Mount Applications



ON Semiconductor®

[www.onsemi.com](http://www.onsemi.com)

### MJD200 (NPN), MJD210 (PNP)

Designed for low voltage, low-power, high-gain audio amplifier applications.

#### Features

- High DC Current Gain
- Lead Formed for Surface Mount Applications in Plastic Sleeves (No Suffix)
- Low Collector–Emitter Saturation Voltage
- High Current–Gain – Bandwidth Product
- Annular Construction for Low Leakage
- Epoxy Meets UL 94 V–0 @ 0.125 in
- NJV Prefix for Automotive and Other Applications Requiring Unique Site and Control Change Requirements; AEC–Q101 Qualified and PPAP Capable
- These Devices are Pb–Free and are RoHS Compliant

#### MAXIMUM RATINGS

Rating	Symbol	Max	Unit
Collector–Base Voltage	$V_{CB}$	40	Vdc
Collector–Emitter Voltage	$V_{CEO}$	25	Vdc
Emitter–Base Voltage	$V_{EB}$	8.0	Vdc
Collector Current – Continuous	$I_C$	5.0	Adc
Collector Current – Peak	$I_{CM}$	10	Adc
Base Current	$I_B$	1.0	Adc
Total Power Dissipation @ $T_C = 25^\circ\text{C}$ Derate above $25^\circ\text{C}$	$P_D$	12.5 0.1	W W/ $^\circ\text{C}$
Total Power Dissipation (Note 1) @ $T_A = 25^\circ\text{C}$ Derate above $25^\circ\text{C}$	$P_D$	1.4 0.011	W W/ $^\circ\text{C}$
Operating and Storage Junction Temperature Range	$T_J, T_{stg}$	–65 to +150	$^\circ\text{C}$
ESD – Human Body Model	HBM	3B	V
ESD – Machine Model	MM	C	V

Stresses exceeding those listed in the Maximum Ratings table may damage the device. If any of these limits are exceeded, device functionality should not be assumed, damage may occur and reliability may be affected.

1. These ratings are applicable when surface mounted on the minimum pad sizes recommended.

#### THERMAL CHARACTERISTICS

Characteristic	Symbol	Max	Unit
Thermal Resistance, Junction–to–Case	$R_{\theta JC}$	10	$^\circ\text{C}/\text{W}$
Thermal Resistance, Junction–to–Ambient (Note 2)	$R_{\theta JA}$	89.3	$^\circ\text{C}/\text{W}$

2. These ratings are applicable when surface mounted on the minimum pad sizes recommended.

### SILICON POWER TRANSISTORS 5 AMPERES 25 VOLTS, 12.5 WATTS

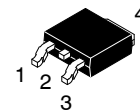
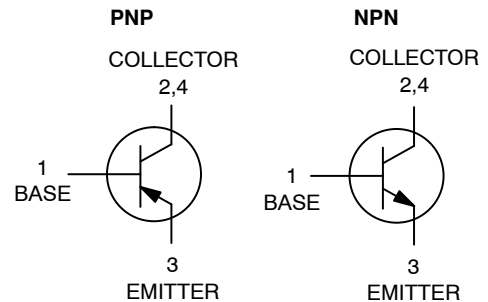

**DPAK  
CASE 369C  
STYLE 1**

#### MARKING DIAGRAM

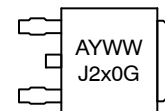

A = Assembly Location  
Y = Year  
WW = Work Week  
x = 1 or 0  
G = Pb–Free Package

#### ORDERING INFORMATION

See detailed ordering and shipping information in the package dimensions section on page 6 of this data sheet.

# MJD200 (NPN), MJD210 (PNP)

## ELECTRICAL CHARACTERISTICS ( $T_C = 25^\circ\text{C}$ unless otherwise noted)

Characteristic	Symbol	Min	Max	Unit
<b>OFF CHARACTERISTICS</b>				
Collector-Emitter Sustaining Voltage (Note 3) ( $I_C = 10\text{ mAdc}$ , $I_B = 0$ )	$V_{CE(sus)}$	25	-	Vdc
Collector Cutoff Current ( $V_{CB} = 40\text{ Vdc}$ , $I_E = 0$ ) ( $V_{CB} = 40\text{ Vdc}$ , $I_E = 0$ , $T_J = 125^\circ\text{C}$ )	$I_{CBO}$	-	100	nAdc $\mu\text{Adc}$
Emitter Cutoff Current ( $V_{BE} = 8\text{ Vdc}$ , $I_C = 0$ )	$I_{EBO}$	-	100	nAdc
<b>ON CHARACTERISTICS</b>				
C Current Gain (Note 3), ( $I_C = 500\text{ mAdc}$ , $V_{CE} = 1\text{ Vdc}$ ) ( $I_C = 2\text{ Adc}$ , $V_{CE} = 1\text{ Vdc}$ ) ( $I_C = 5\text{ Adc}$ , $V_{CE} = 2\text{ Vdc}$ )	$h_{FE}$	70 45 10	- 180 -	-
Collector-Emitter Saturation Voltage (Note 3) ( $I_C = 500\text{ mAdc}$ , $I_B = 50\text{ mAdc}$ ) ( $I_C = 2\text{ Adc}$ , $I_B = 200\text{ mAdc}$ ) ( $I_C = 5\text{ Adc}$ , $I_B = 1\text{ Adc}$ )	$V_{CE(sat)}$	- - -	0.3 0.75 1.8	Vdc
Base-Emitter Saturation Voltage (Note 3) ( $I_C = 5\text{ Adc}$ , $I_B = 1\text{ Adc}$ )	$V_{BE(sat)}$	-	2.5	Vdc
Base-Emitter On Voltage (Note 3) ( $I_C = 2\text{ Adc}$ , $V_{CE} = 1\text{ Vdc}$ )	$V_{BE(on)}$	-	1.6	Vdc
<b>DYNAMIC CHARACTERISTICS</b>				
Current-Gain - Bandwidth Product (Note 4) ( $I_C = 100\text{ mAdc}$ , $V_{CE} = 10\text{ Vdc}$ , $f_{test} = 10\text{ MHz}$ )	$f_T$	65	-	MHz
Output Capacitance ( $V_{CB} = 10\text{ Vdc}$ , $I_E = 0$ , $f = 0.1\text{ MHz}$ ) MJD200 MJD210, NJVMJD210T4G	$C_{ob}$	- -	80 120	pF

3. Pulse Test: Pulse Width = 300  $\mu\text{s}$ , Duty Cycle  $\approx 2\%$ .

4.  $f_T = |h_{fe}| \cdot f_{test}$ .

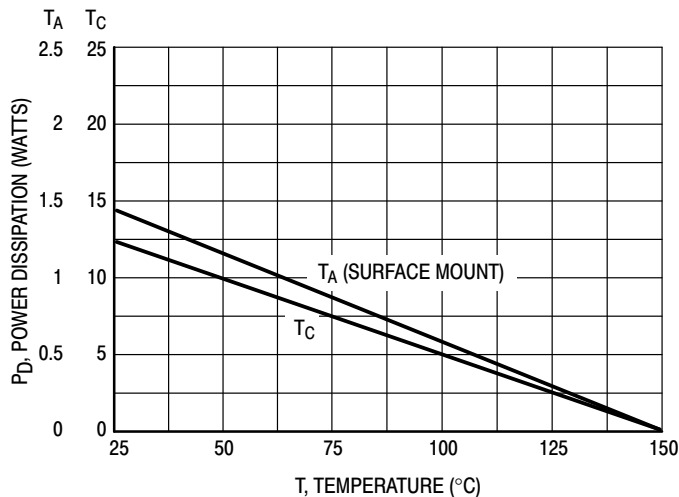

Figure 1. Power Derating

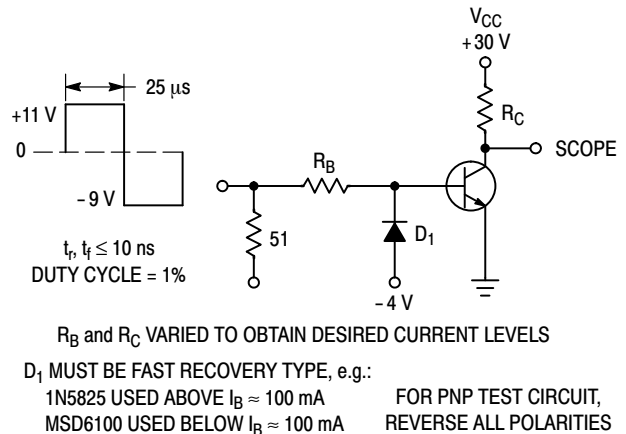

Figure 2. Switching Time Test Circuit

# MJD200 (NPN), MJD210 (PNP)

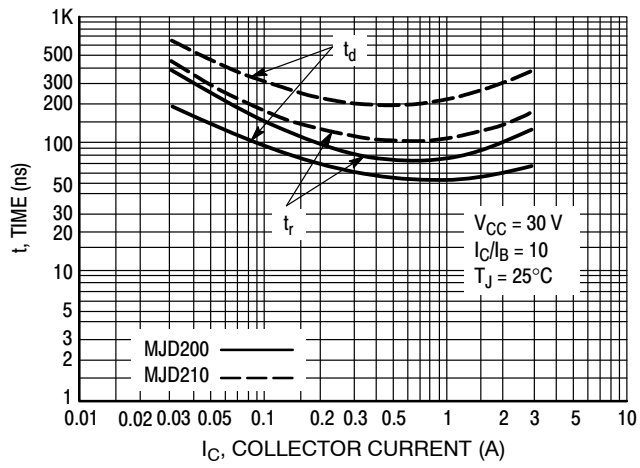

Figure 3. Turn-On Time

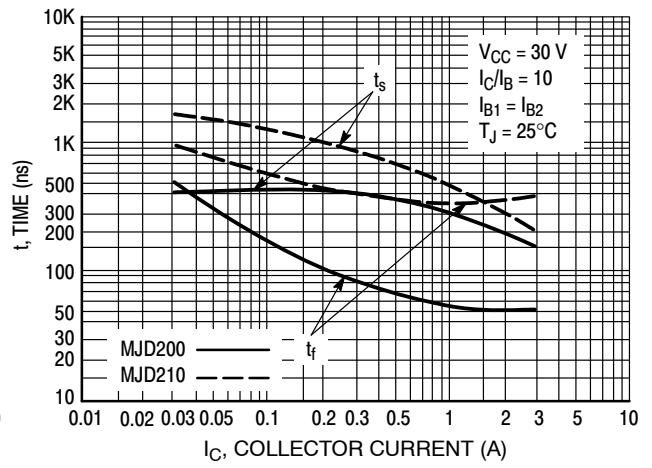

Figure 4. Turn-Off Time

# MJD200 (NPN), MJD210 (PNP)

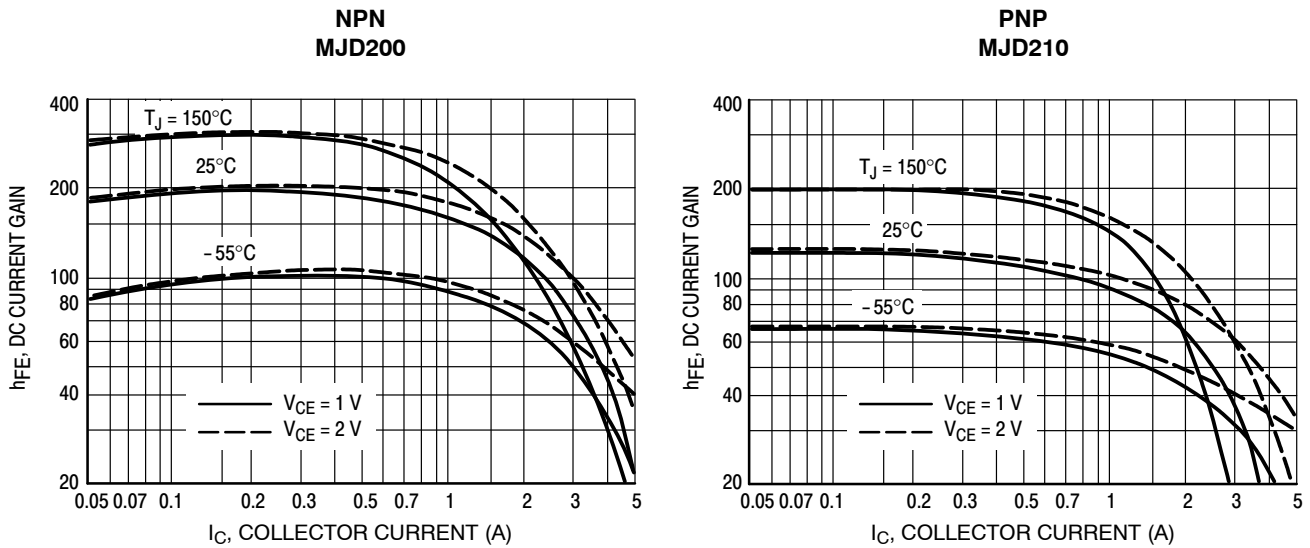

Figure 5. DC Current Gain

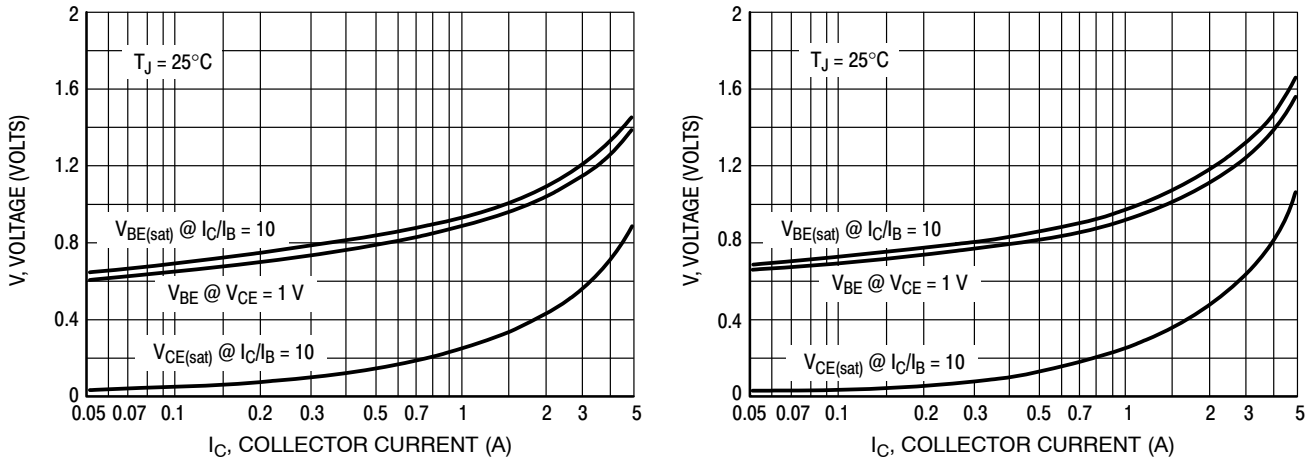

Figure 6. "On" Voltage

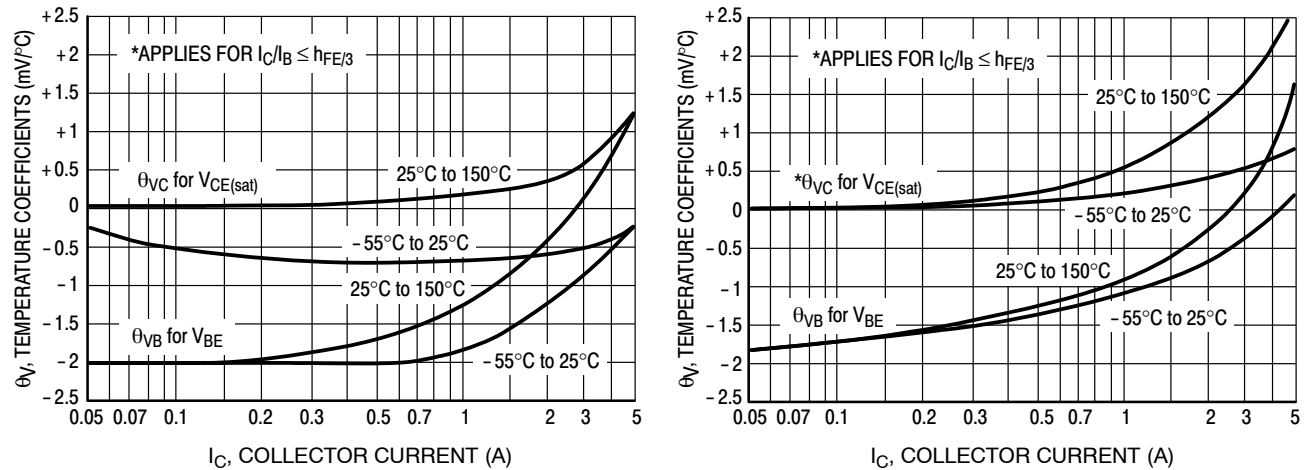

Figure 7. Temperature Coefficients

# MJD200 (NPN), MJD210 (PNP)

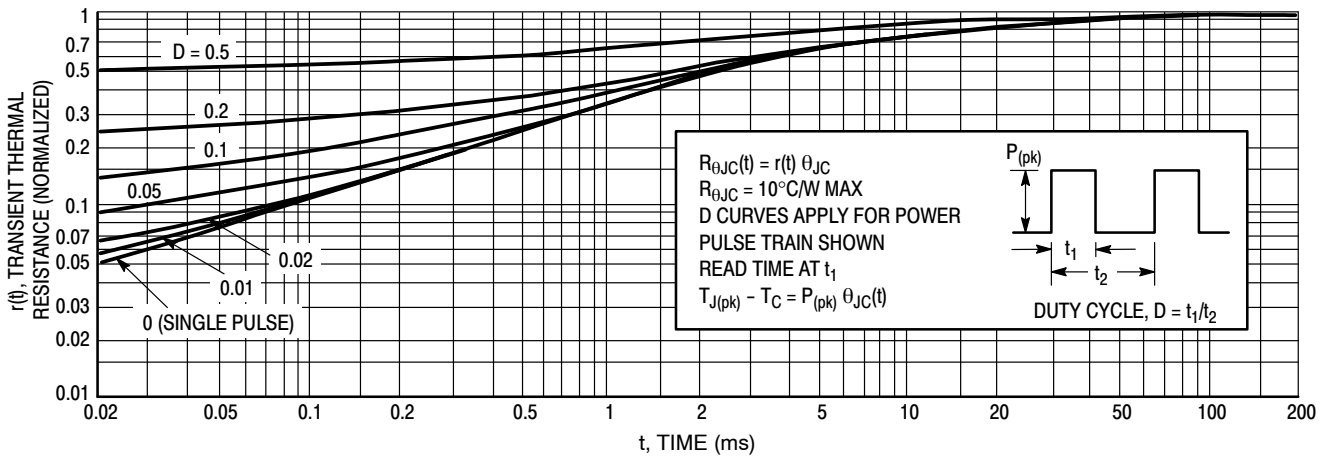

Figure 8. Thermal Response

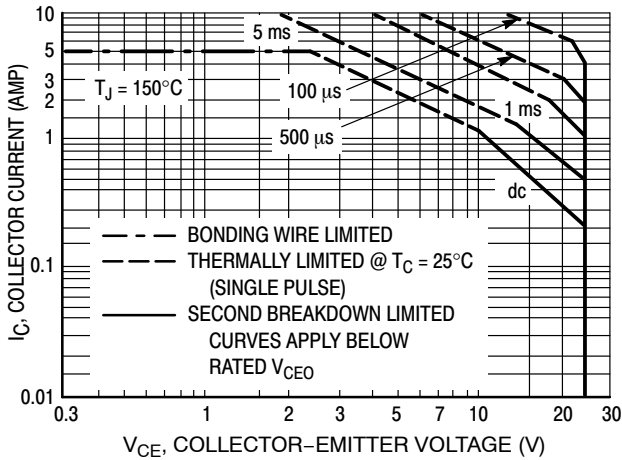

Figure 9. Active Region Safe Operating Area

There are two limitations on the power handling ability of a transistor: average junction temperature and second breakdown. Safe operating area curves indicate  $I_C - V_{CE}$  limits of the transistor that must be observed for reliable operation; i.e., the transistor must not be subjected to greater dissipation than the curves indicate.

The data of Figure 9 is based on  $T_{J(pk)} = 150^{\circ}\text{C}$ ;  $T_C$  is variable depending on conditions. Second breakdown pulse limits are valid for duty cycles to 10% provided  $T_{J(pk)} \leq 150^{\circ}\text{C}$ .  $T_{J(pk)}$  may be calculated from the data in Figure 8. At high case temperatures, thermal limitations will reduce the power that can be handled to values less than the limitations imposed by second breakdown.

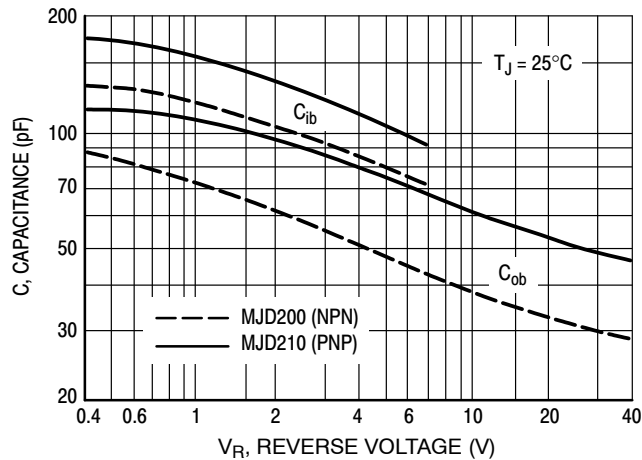

Figure 10. Capacitance

## MJD200 (NPN), MJD210 (PNP)

### ORDERING INFORMATION

Device	Package Type	Shipping†
MJD200G	DPAK (Pb-Free)	75 Units / Rail
MJD200RLG	DPAK (Pb-Free)	1,800 / Tape & Reel
MJD200T4G	DPAK (Pb-Free)	2,500 / Tape & Reel
MJD210G	DPAK (Pb-Free)	75 Units / Rail
MJD210RLG	DPAK (Pb-Free)	1,800 / Tape & Reel
MJD210T4G	DPAK (Pb-Free)	2,500 / Tape & Reel
NJVMJD210T4G*	DPAK (Pb-Free)	2,500 / Tape & Reel

†For information on tape and reel specifications, including part orientation and tape sizes, please refer to our Tape and Reel Packaging Specifications Brochure, BRD8011/D.

\*NJV Prefix for Automotive and Other Applications Requiring Unique Site and Control Change Requirements; AEC-Q101 Qualified and PPAP Capable

# MECHANICAL CASE OUTLINE

## PACKAGE DIMENSIONS

ON Semiconductor®



SCALE 1:1

### DPAK (SINGLE GAUGE)

#### CASE 369C

#### ISSUE F

DATE 21 JUL 2015



NOTES:

1. DIMENSIONING AND TOLERANCING PER ASME Y14.5M, 1994.
2. CONTROLLING DIMENSION: INCHES.
3. THERMAL PAD CONTOUR OPTIONAL WITHIN DIMENSIONS b3, L3 and Z.
4. DIMENSIONS D AND E DO NOT INCLUDE MOLD FLASH, PROTRUSIONS, OR BURRS. MOLD FLASH, PROTRUSIONS, OR GATE BURRS SHALL NOT EXCEED 0.006 INCHES PER SIDE.
5. DIMENSIONS D AND E ARE DETERMINED AT THE OUTERMOST EXTREMES OF THE PLASTIC BODY.
6. DATUMS A AND B ARE DETERMINED AT DATUM PLANE H.
7. OPTIONAL MOLD FEATURE.

DIM	INCHES		MILLIMETERS	
	MIN	MAX	MIN	MAX
A	0.086	0.094	2.18	2.38
A1	0.000	0.005	0.00	0.13
b	0.025	0.035	0.63	0.89
b2	0.028	0.045	0.72	1.14
b3	0.180	0.215	4.57	5.46
c	0.018	0.024	0.46	0.61
c2	0.018	0.024	0.46	0.61
D	0.235	0.245	5.97	6.22
E	0.250	0.265	6.35	6.73
e	0.090 BSC		2.29 BSC	
H	0.370	0.410	9.40	10.41
L	0.055	0.070	1.40	1.78
L1	0.114 REF		2.90 REF	
L2	0.020 BSC		0.51 BSC	
L3	0.035	0.050	0.89	1.27
L4	---	0.040	---	1.01
Z	0.155	---	3.93	---

### GENERIC MARKING DIAGRAM\*

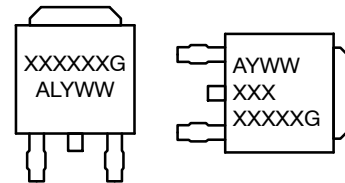

IC

Discrete

- XXXXXX = Device Code
- A = Assembly Location
- L = Wafer Lot
- Y = Year
- WW = Work Week
- G = Pb-Free Package

\*This information is generic. Please refer to device data sheet for actual part marking.

- |  |  |   |   |  |
|--|--|---|---|--|
| <p>STYLE 1:<br/>PIN 1. BASE<br/>2. COLLECTOR<br/>3. EMITTER<br/>4. COLLECTOR</p> | <p>STYLE 2:<br/>PIN 1. GATE<br/>2. DRAIN<br/>3. SOURCE<br/>4. DRAIN</p>          | <p>STYLE 3:<br/>PIN 1. ANODE<br/>2. CATHODE<br/>3. ANODE<br/>4. CATHODE</p> | <p>STYLE 4:<br/>PIN 1. CATHODE<br/>2. ANODE<br/>3. GATE<br/>4. ANODE</p>              | <p>STYLE 5:<br/>PIN 1. GATE<br/>2. ANODE<br/>3. CATHODE<br/>4. ANODE</p>     |
| <p>STYLE 6:<br/>PIN 1. MT1<br/>2. MT2<br/>3. GATE<br/>4. MT2</p>                 | <p>STYLE 7:<br/>PIN 1. GATE<br/>2. COLLECTOR<br/>3. EMITTER<br/>4. COLLECTOR</p> | <p>STYLE 8:<br/>PIN 1. N/C<br/>2. CATHODE<br/>3. ANODE<br/>4. CATHODE</p>   | <p>STYLE 9:<br/>PIN 1. ANODE<br/>2. CATHODE<br/>3. RESISTOR ADJUST<br/>4. CATHODE</p> | <p>STYLE 10:<br/>PIN 1. CATHODE<br/>2. ANODE<br/>3. CATHODE<br/>4. ANODE</p> |

### SOLDERING FOOTPRINT\*

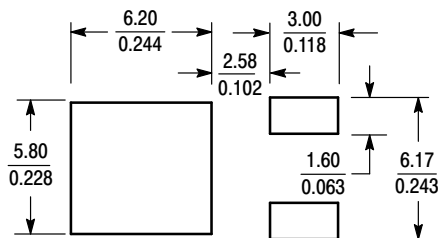

SCALE 3:1 (mm / inches)

\*For additional information on our Pb-Free strategy and soldering details, please download the ON Semiconductor Soldering and Mounting Techniques Reference Manual, SOLDERRM/D.

<b>DOCUMENT NUMBER:</b>	<b>98AON10527D</b>	Electronic versions are uncontrolled except when accessed directly from the Document Repository. Printed versions are uncontrolled except when stamped "CONTROLLED COPY" in red.
<b>DESCRIPTION:</b>	<b>DPAK (SINGLE GAUGE)</b>	<b>PAGE 1 OF 1</b>

ON Semiconductor and ON are trademarks of Semiconductor Components Industries, LLC dba ON Semiconductor or its subsidiaries in the United States and/or other countries. ON Semiconductor reserves the right to make changes without further notice to any products herein. ON Semiconductor makes no warranty, representation or guarantee regarding the suitability of its products for any particular purpose, nor does ON Semiconductor assume any liability arising out of the application or use of any product or circuit, and specifically disclaims any and all liability, including without limitation special, consequential or incidental damages. ON Semiconductor does not convey any license under its patent rights nor the rights of others.

**onsemi**, **Onsemi**, and other names, marks, and brands are registered and/or common law trademarks of Semiconductor Components Industries, LLC dba "**onsemi**" or its affiliates and/or subsidiaries in the United States and/or other countries. **onsemi** owns the rights to a number of patents, trademarks, copyrights, trade secrets, and other intellectual property. A listing of **onsemi**'s product/patent coverage may be accessed at [www.onsemi.com/site/pdf/Patent-Marking.pdf](http://www.onsemi.com/site/pdf/Patent-Marking.pdf). **onsemi** reserves the right to make changes at any time to any products or information herein, without notice. The information herein is provided "as-is" and **onsemi** makes no warranty, representation or guarantee regarding the accuracy of the information, product features, availability, functionality, or suitability of its products for any particular purpose, nor does **onsemi** assume any liability arising out of the application or use of any product or circuit, and specifically disclaims any and all liability, including without limitation special, consequential or incidental damages. Buyer is responsible for its products and applications using **onsemi** products, including compliance with all laws, regulations and safety requirements or standards, regardless of any support or applications information provided by **onsemi**. "Typical" parameters which may be provided in **onsemi** data sheets and/or specifications can and do vary in different applications and actual performance may vary over time. All operating parameters, including "Typicals" must be validated for each customer application by customer's technical experts. **onsemi** does not convey any license under any of its intellectual property rights nor the rights of others. **onsemi** products are not designed, intended, or authorized for use as a critical component in life support systems or any FDA Class 3 medical devices or medical devices with a same or similar classification in a foreign jurisdiction or any devices intended for implantation in the human body. Should Buyer purchase or use **onsemi** products for any such unintended or unauthorized application, Buyer shall indemnify and hold **onsemi** and its officers, employees, subsidiaries, affiliates, and distributors harmless against all claims, costs, damages, and expenses, and reasonable attorney fees arising out of, directly or indirectly, any claim of personal injury or death associated with such unintended or unauthorized use, even if such claim alleges that **onsemi** was negligent regarding the design or manufacture of the part. **onsemi** is an Equal Opportunity/Affirmative Action Employer. This literature is subject to all applicable copyright laws and is not for resale in any manner.

## PUBLICATION ORDERING INFORMATION

### LITERATURE FULFILLMENT:

Email Requests to: [orderlit@onsemi.com](mailto:orderlit@onsemi.com)

**onsemi Website:** [www.onsemi.com](http://www.onsemi.com)

### TECHNICAL SUPPORT

**North American Technical Support:**  
Voice Mail: 1 800-282-9855 Toll Free USA/Canada  
Phone: 011 421 33 790 2910

**Europe, Middle East and Africa Technical Support:**

Phone: 00421 33 790 2910

For additional information, please contact your local Sales Representative