

DUAL OPERATIONAL AMPLIFIER

■ GENERAL DESCRIPTION

The NJM4558C integrated circuit is a dual high-gain operational amplifier internally compensated and constructed on a single silicon chip.

Combining the features of the NJM741 with the close parameter matching and tracking of a dual device on a monolithic chip results in unique performance characteristics. Excellent channel separation allows the use of the dual device in single NJM741 operational amplifier applications providing density. It is especially well suited for applications in differential-in, differential-out as well as in potentiometric amplifiers and where gain and phase matched channels are mandatory.

■ FEATURES

- Operating Voltage $\pm 4V \sim \pm 18V$
- High Voltage Gain 100dB typ.
- High Input Resistance $5M\Omega$ typ.
- Bipolar Technology
- Package Outline SOP8, SSOP8
- Internal ESD protection
Human body model (HBM) $\pm 2000V$ typ.

■ PACKAGE OUTLINE



NJM4558CG
(SOP8)



NJM4558CV
(SSOP8)

■ PIN CONFIGURATION

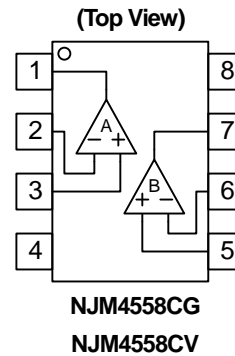

- PIN FUNCTION**
- 1.A OUTPUT
 - 2.A -INPUT
 - 3.A +INPUT
 - 4.V⁻
 - 5.B +INPUT
 - 6.B -INPUT
 - 7.B OUTPUT
 - 8.V⁺

■ EQUIVALENT CIRCUIT (1/2 Shown)

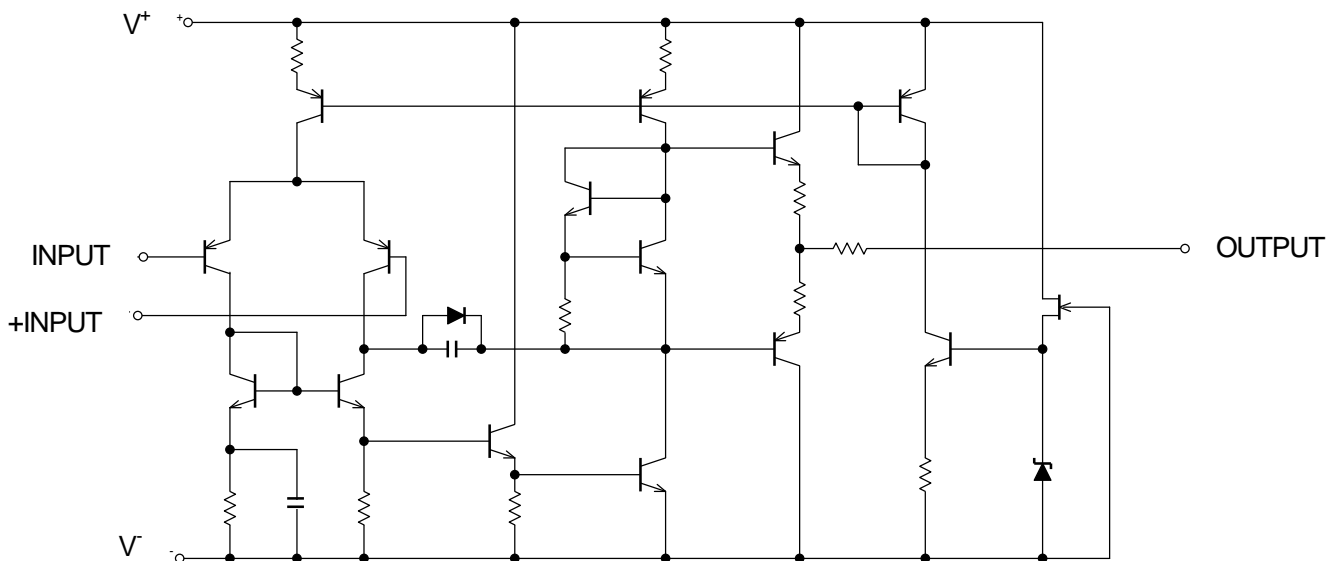

NJM4558C

■ ABSOLUTE MAXIMUM RATINGS (Ta=25°C, unless otherwise noted.)

PARAMETER	SYMBOL	RATING	UNIT
Supply Voltage	V ⁺ /V ⁻	±18	V
Differential Input Voltage (Note1) (Note2)	V _{ID}	±36	V
Input Voltage (Note2)	V _{IC}	±18	V
Power Dissipation	P _D	SOP : 550 (Note3) 820(Note4) SSOP : 350 (Note3) 440(Note4)	mW
Operating Temperature Range	T _{opr}	- 40~+85	°C
Storage Temperature Range	T _{stg}	- 65~+125	°C

(Note1) Differential voltage is the voltage difference between +INPUT and -INPUT.

(Note2) For supply voltage less than ±15V, the absolute maximum rating is equal to the supply voltage.

The normal operation will establish when any input is within the Common Mode Input Voltage Range of electrical characteristics.

(Note3) EIA/JEDEC STANDARD Test board (76.2 x 114.3 x 1.6mm, 2layers, FR-4) mounting

(Note4) EIA/JEDEC STANDARD Test board (76.2 x 114.3 x 1.6mm, 4layers, FR-4) mounting

■ RECOMMENDED OPERATING CONDITIONS (Ta=25°C)

PARAMETER	SYMBOL	CONDITION	MIN.	TYP.	MAX.	UNIT
Supply Voltage	V ⁺ /V ⁻		±4	-	±18	V

■ ELECTRICAL CHARACTERISTICS (V⁺/V⁻=±15V, Ta=25°C, unless otherwise noted.)

PARAMETER	SYMBOL	TEST CONDITION	MIN.	TYP.	MAX.	UNIT
Input Offset Voltage	V _{IO}	R _S ≤10kΩ	-	0.5	6	mV
Input Offset Current	I _{IO}		-	5	200	nA
Input Bias Current	I _B		-	25	500	nA
Input Resistance	R _{IN}		-	3	-	MΩ
Large Signal Voltage Gain	A _V	R _L ≥2kΩ, V _O =±10V	86	100	-	dB
Maximum Output Voltage Swing 1	V _{OM1}	R _L ≥10kΩ	± 12	± 14	-	V
Maximum Output Voltage Swing 2	V _{OM2}	R _L ≥2kΩ	± 10	± 13	-	V
Input Common Mode Voltage Range	V _{ICM}		± 12	± 14	-	V
Common Mode Rejection Ratio	CMR	R _S ≤10kΩ	70	95	-	dB
Supply Voltage Rejection Ratio	SVR	R _S ≤10kΩ	76.5	100	-	dB
Operating Current	I _{CC}		-	3.5	5.7	mA
Slew Rate	SR		-	1.5	-	V/μs
Gain Bandwidth Product	GBP	f=10kHz	-	3.5	-	MHz
Equivalent Input Noise Voltage1	V _{NI}	RIAA, R _S =2.2kΩ, 30kHz LPF	-	1.4	-	μVrms
Equivalent Input Noise Voltage2	e _n	f=1kHz	-	12	-	nV/√Hz

■ TYPICAL CHARACTERISTICS

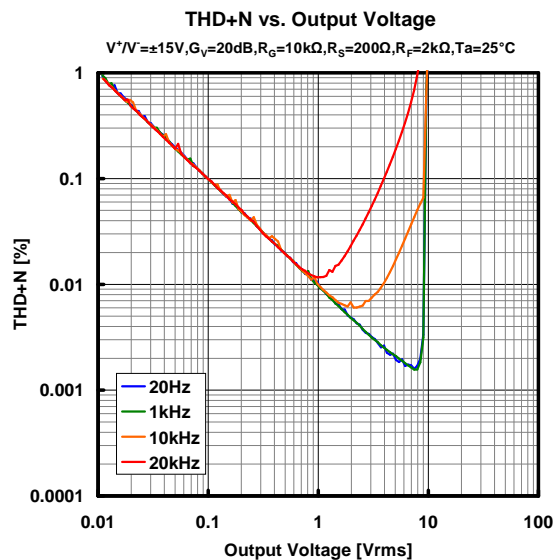
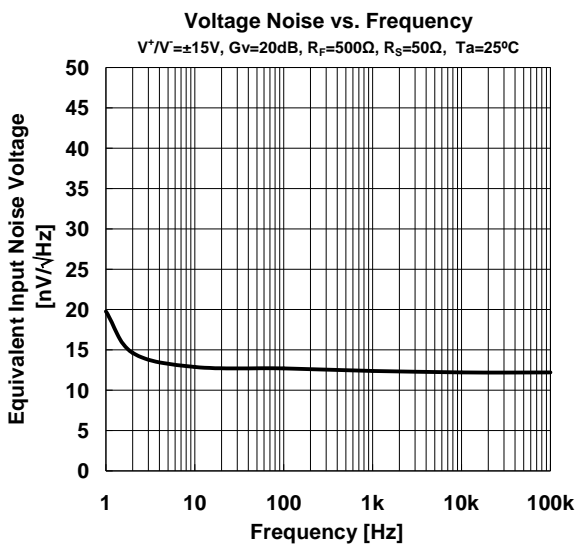
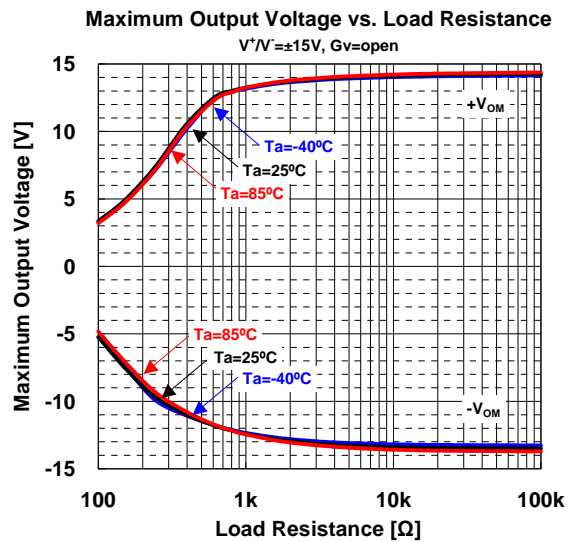
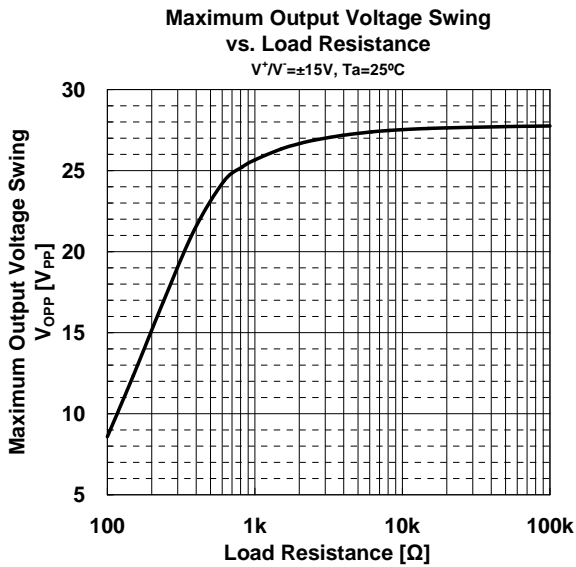
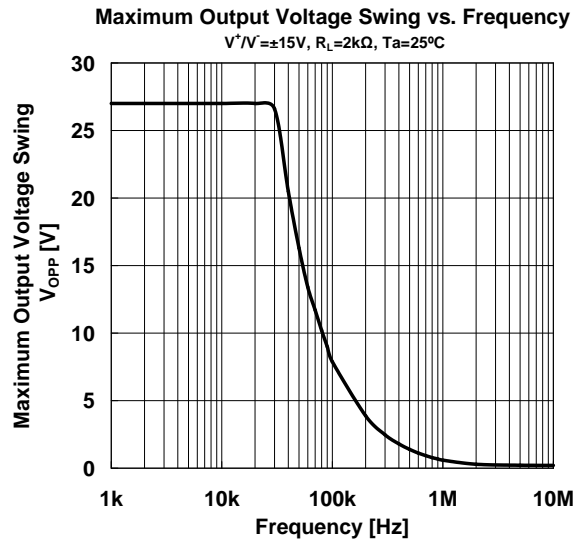
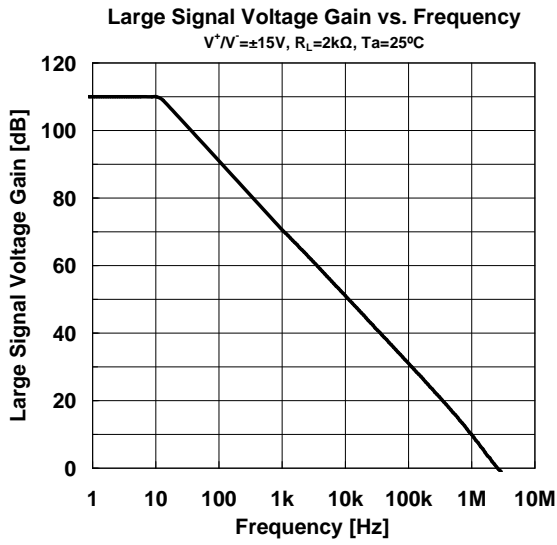

NJM4558C

■ TYPICAL CHARACTERISTICS

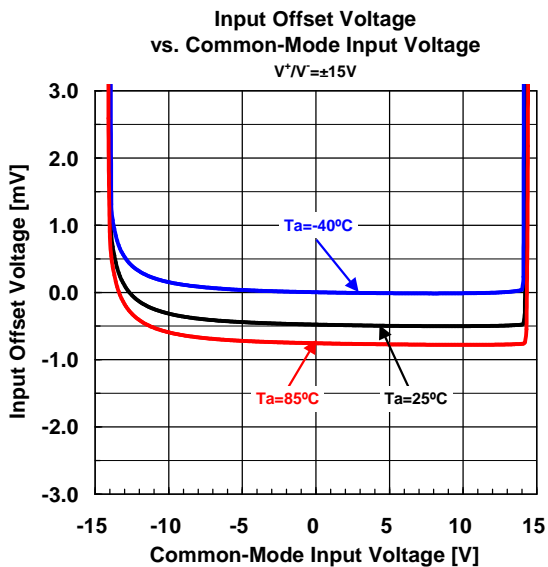
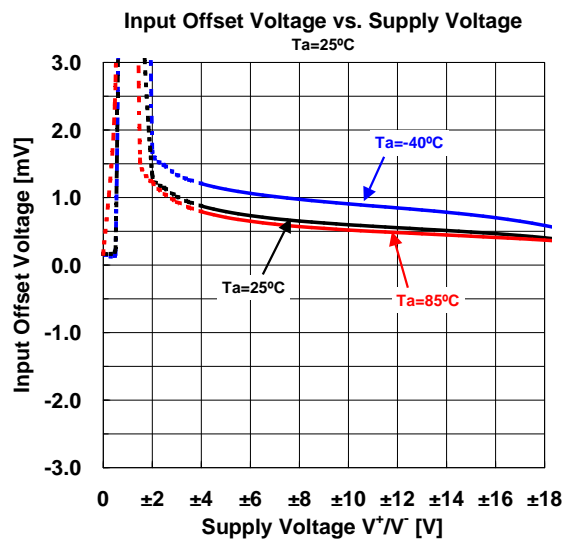
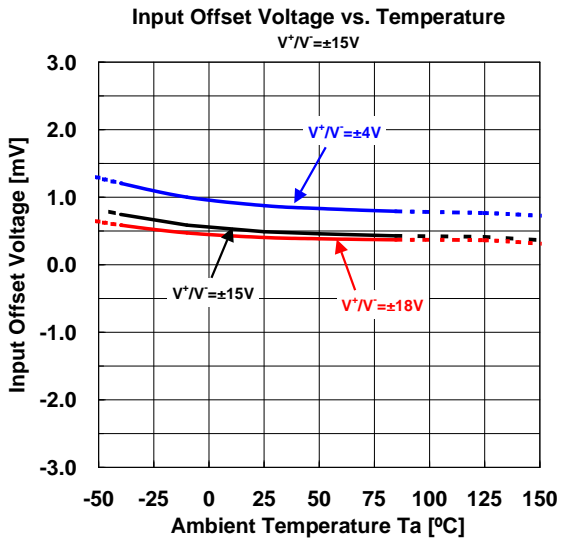
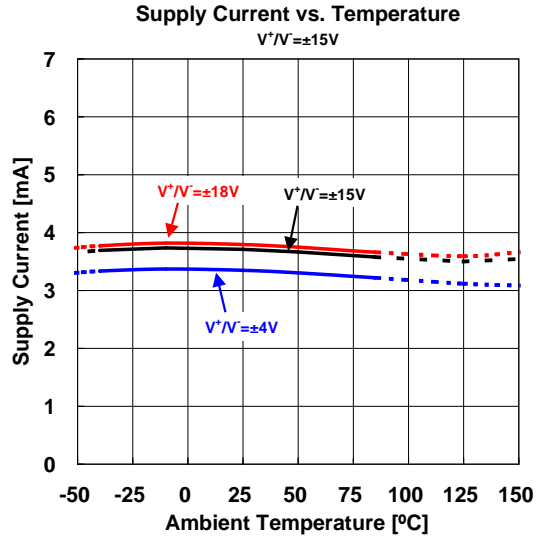
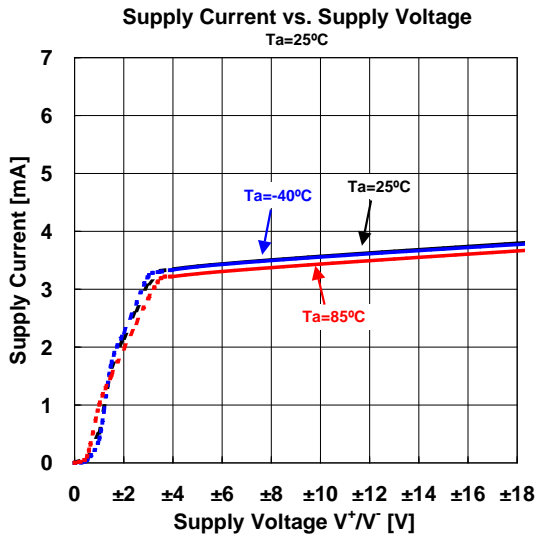

■ TYPICAL CHARACTERISTICS

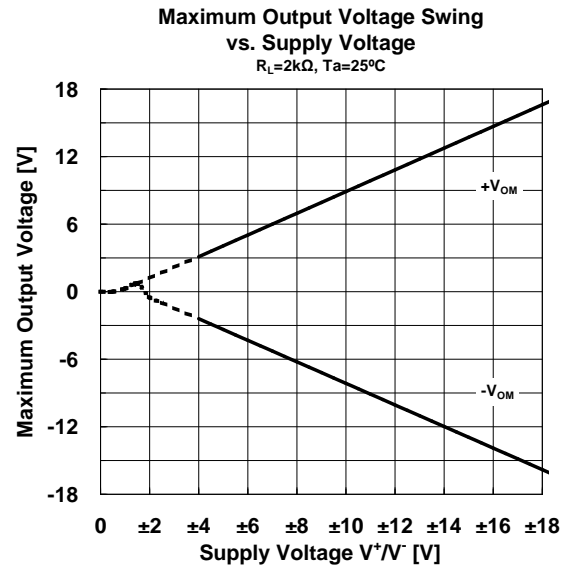
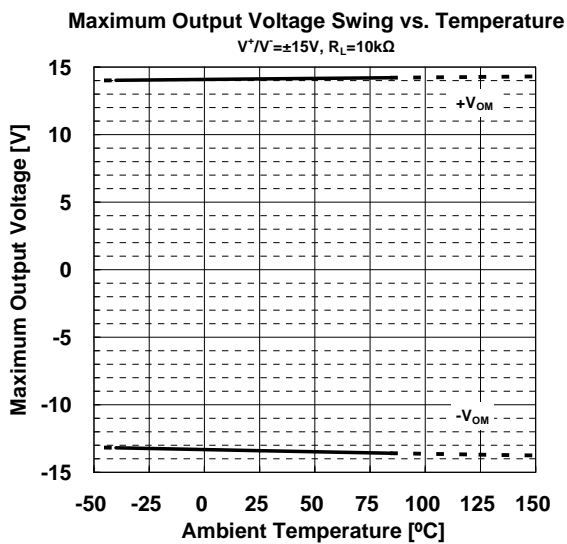
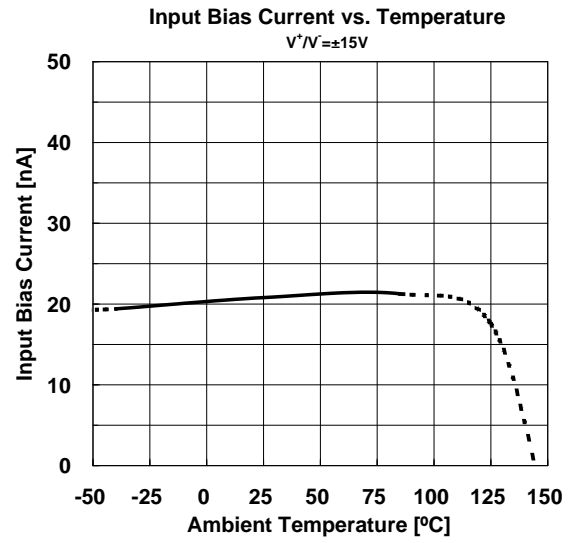
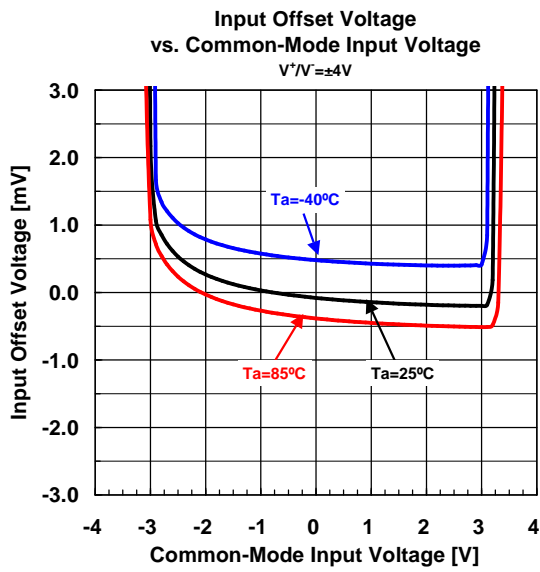

NJM4558C

■PACKAGE OUTLINE UNIT : mm

SOP8

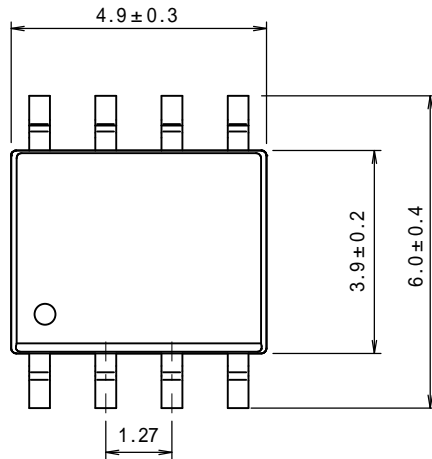

UNIT: mm

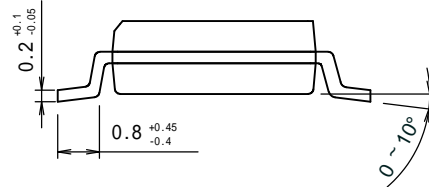
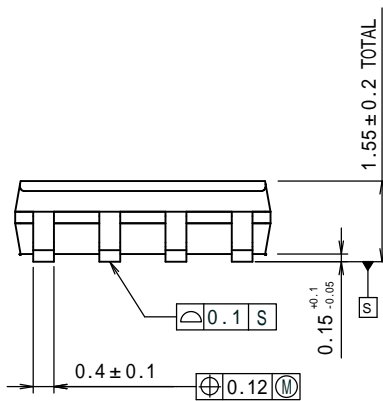

SSOP8

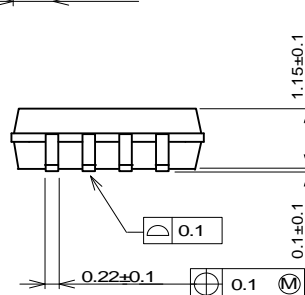
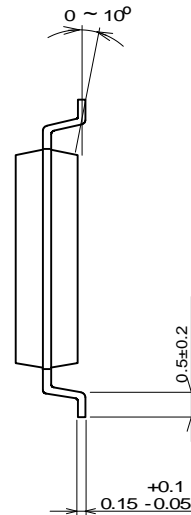
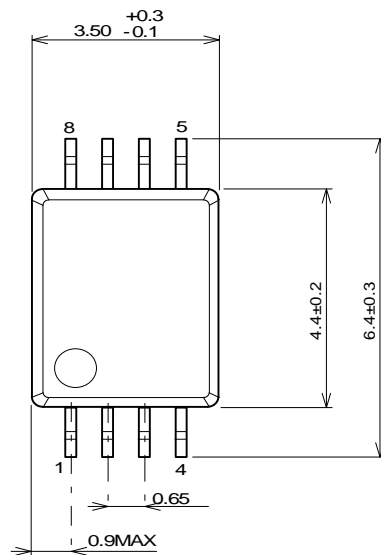

[CAUTION]
 The specifications on this databook are only given for information, without any guarantee as regards either mistakes or omissions. The application circuits in this databook are described only to show representative usages of the product and not intended for the guarantee or permission of any right including the industrial rights.