

## Technical Data Sheet

### Full Color Side View LEDs (Height 0.8mm)

**99-235/RSGHB7C-A07/2D**

#### Features

- White package.
- Optical indicator.
- Colorless clear window.
- Ideal for backlight and light pipe application.
- Inter reflector.
- Wide viewing angle.
- Suitable for vapor-phase reflow, Infrared reflow and wave solder processes.
- Computable with automatic placement equipment.
- Available on tape and reel (12mm Tape)
- Pb-free
- The product itself will remain within RoHS compliant version.



#### Descriptions

- The 99-235 series is available in soft red, green and blue. Due to the package design, the LED has wide viewing angle and optimized light coupling by inter reflector. This feature makes the ideal for light pipe application. The low current requirement makes this device ideal for portable equipment or any other application where power is at a premium.

#### Applications

- Telecommunication: indicator and backlighting in telephone and fax.
- Flat backlight for LCD's, switches and symbols.
- Light pipe application.
- General use.

#### Device Selection Guide

Chip			Resin Color
Type	Material	Emitted Color	
RS	AlGaInP	Brilliant Red	Water Clear
GH	InGaN	Brilliant Green	
B7	InGaN	Blue	

**Technical Data Sheet - Preliminary**

**Full Color Side View LEDs (Height 0.8mm)**

**99-235/RSGHB7C-A07/2D**

**Package Outline Dimensions**

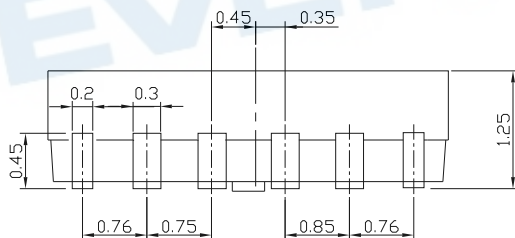
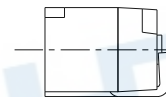
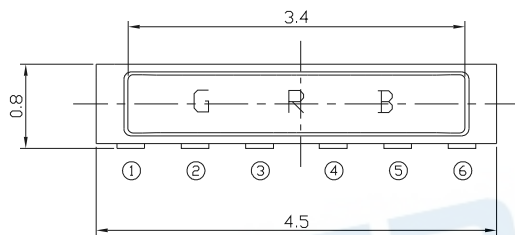
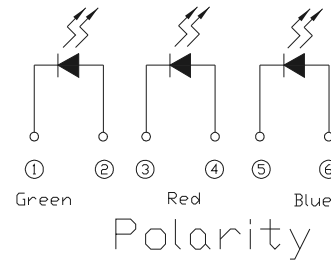
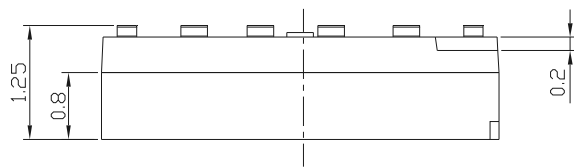

Recommended soldering pad design

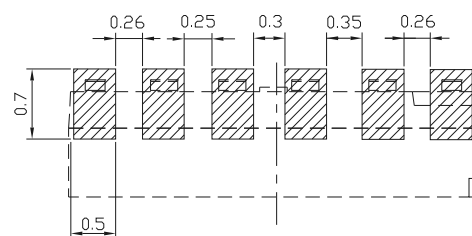

**Note:** The tolerances unless mentioned is  $\pm 0.1\text{mm}$  ;Unit = mm

**Technical Data Sheet - Preliminary****Full Color Side View LEDs (Height 0.8mm)****99-235/RSGHB7C-A07/2D****Absolute Maximum Ratings (Ta=25°C)**

Parameter	Symbol	Rating	Unit
Reverse Voltage	V <sub>R</sub>	5	V
Forward Current	I <sub>F</sub>	RS	50
		GH	30
		B7	30
Peak Forward Current(Duty 1/10@ 1KHZ)	I <sub>FP</sub>	RS	100
		GH	100
		B7	100
Power Dissipation	P <sub>d</sub>	RS	130
		GH	110
		B7	110
Electrostatic Discharge(HBM)	ESD	RS	2000
		GH	1000
		B7	1000
Operating Temperature	T <sub>opr</sub>	-40 ~ +85	°C
Storage Temperature	T <sub>stg</sub>	-40~ +90	°C
Soldering Temperature	T <sub>sol</sub>	Reflow Soldering : 260 °C for 10 sec. Hand Soldering : 350 °C for 3 sec.	

**Technical Data Sheet - Preliminary****Full Color Side View LEDs (Height 0.8mm)****99-235/RSGHB7C-A07/2D****Electro-Optical Characteristics (Ta=25°C)**

Parameter	Symbol	Min.	Typ.	Max.	Unit	Condition	
Luminous Intensity	I <sub>v</sub>	RS	200	-----	800	mcd	I <sub>F</sub> =20mA
		GH	500	-----	1300		
		B7	100	-----	550		
Viewing Angle	2θ 1/2	-----	120	-----	deg	I <sub>F</sub> =20mA	
Peak Wavelength	λ <sub>p</sub>	RS	-----	632	-----	nm	I <sub>F</sub> =20mA
		GH	-----	518	-----		
		B7	-----	468	-----		
Dominant Wavelength	λ <sub>d</sub>	RS	619	-----	629	nm	I <sub>F</sub> =20mA
		GH	525	-----	535		
		B7	455	-----	465		
Spectrum Radiation Bandwidth	Δλ	RS	-----	20	-----	nm	I <sub>F</sub> =20mA
		GH	-----	36	-----		
		B7	-----	26	-----		
Forward Voltage	V <sub>F</sub>	RS	-----	2.0	2.4	V	I <sub>F</sub> =20mA
		GH	-----	3.3	3.7		
		B7	-----	3.3	3.7		
Reverse Current	I <sub>R</sub>	RS	-----	-----	10	μA	V <sub>R</sub> =5V
		GH	-----	-----	50		
		B7	-----	-----	50		

**Notes:**

- 1.Tolerance of Luminous Intensity ±11%
- 2.Tolerance of Dominant Wavelength ±1nm

**Technical Data Sheet - Preliminary**

**Full Color Side View LEDs (Height 0.8mm)**

**99-235/RSGHB7C-A07/2D**

**Typical Electro-Optical Characteristics Curves(RS)**

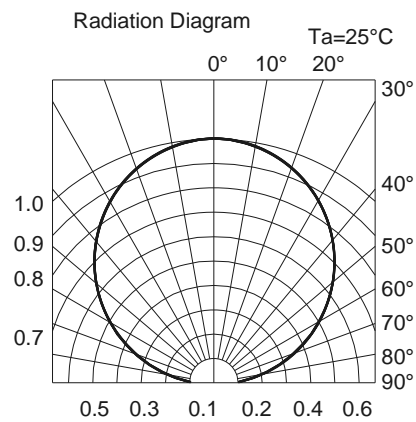
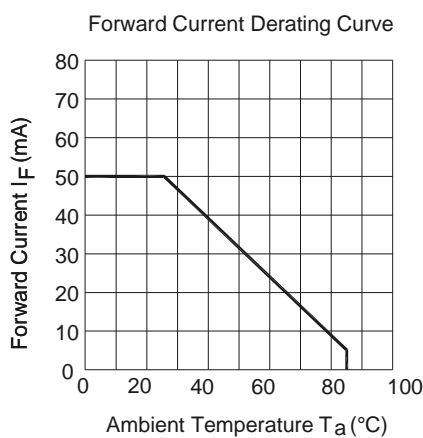
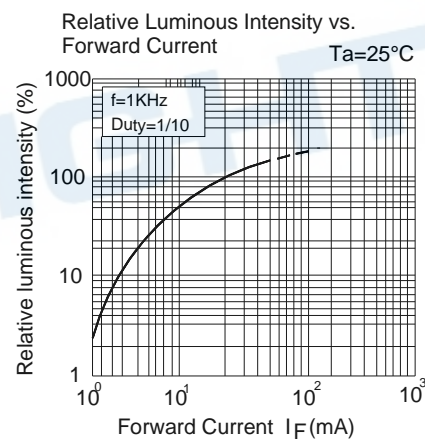
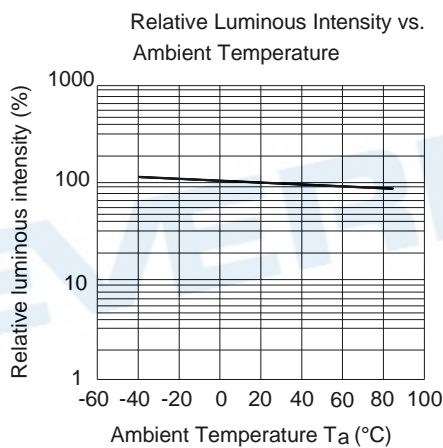
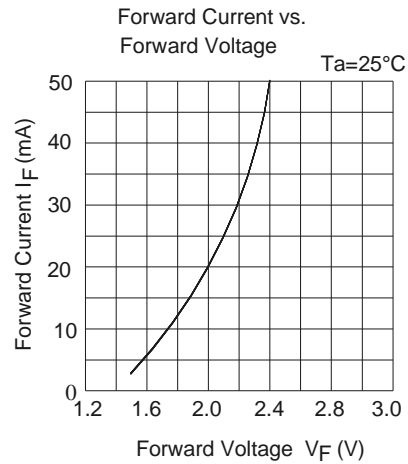
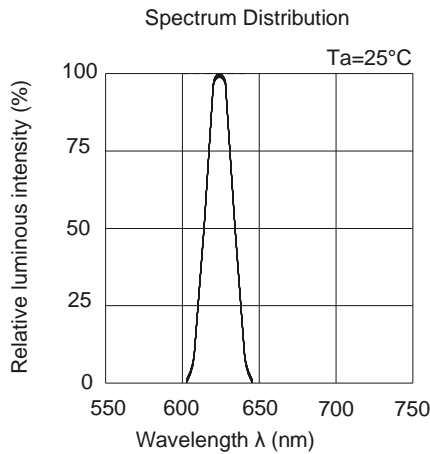

**Typical Electro-Optical Characteristics Curves(GH)**

**Technical Data Sheet - Preliminary**

**Full Color Side View LEDs (Height 0.8mm)**

**99-235/RSGHB7C-A07/2D**

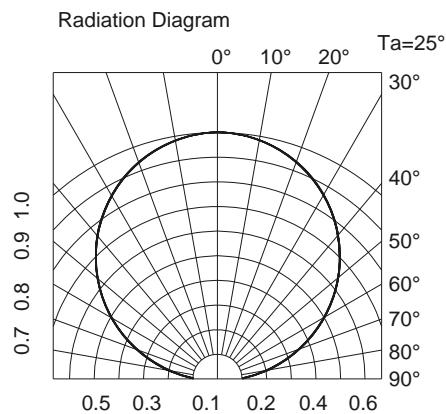
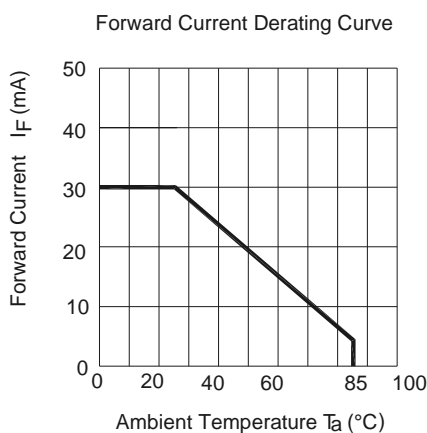
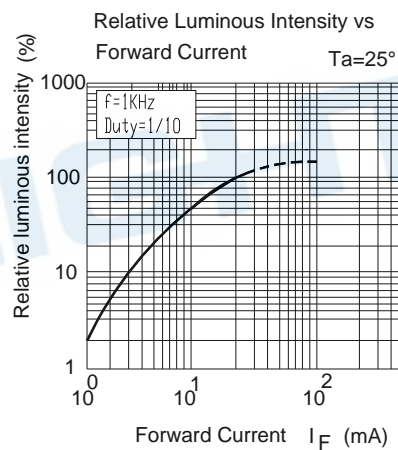
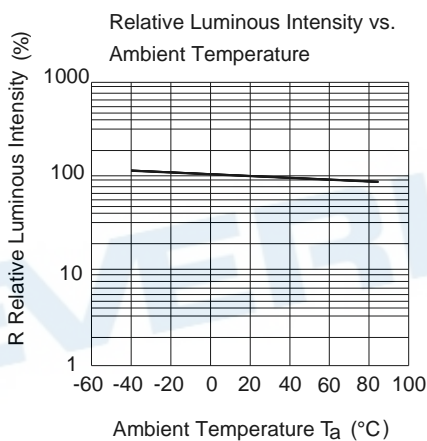
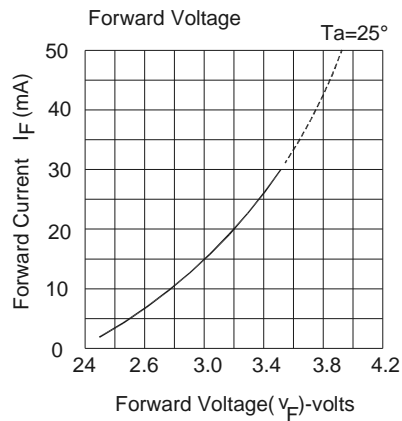
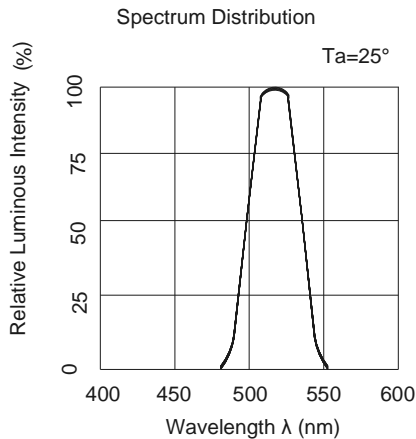

**Technical Data Sheet - Preliminary**

**Full Color Side View LEDs (Height 0.8mm)**

**99-235/RSGHB7C-A07/2D**

**Typical Electro-Optical Characteristics Curves(B7)**

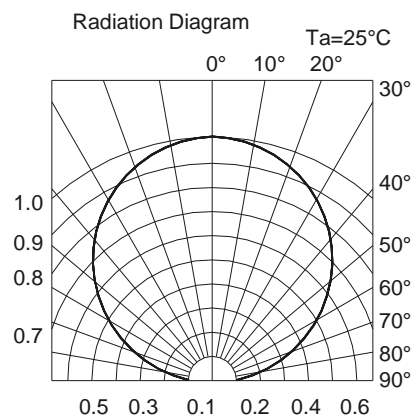
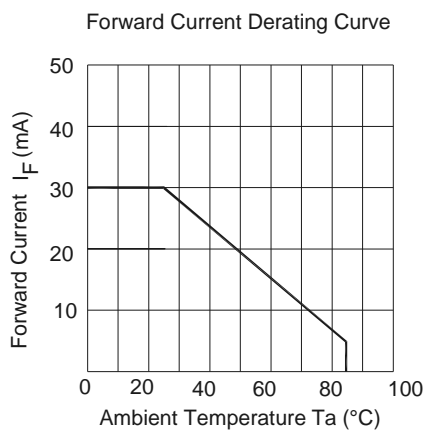
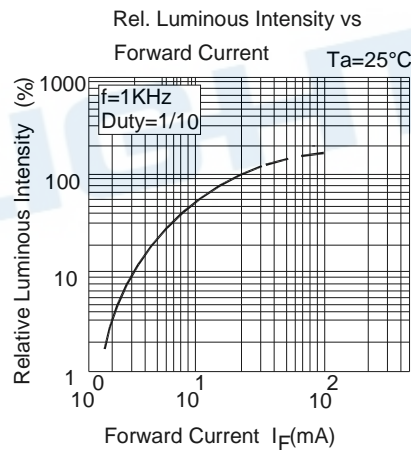
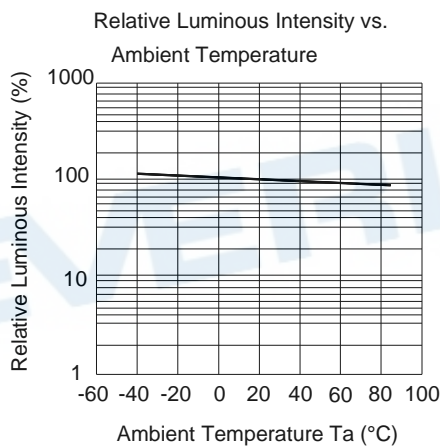
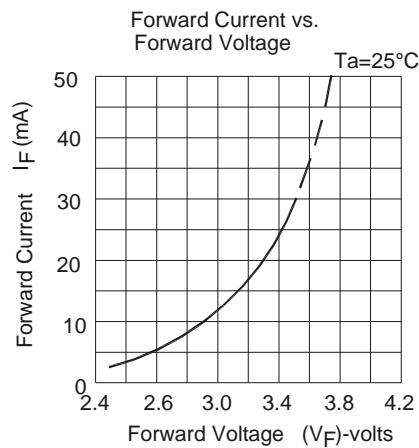
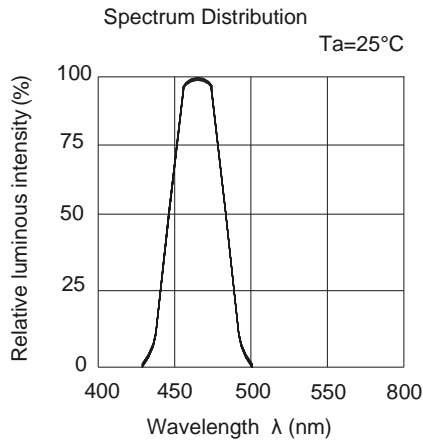

**Technical Data Sheet - Preliminary**

**Full Color Side View LEDs (Height 0.8mm)**

**99-235/RSGHB7C-A07/2D**

**Label Explanation**

CAT: Luminous Intensity Rank

HUE: Dom. Wavelength Rank

REF: Forward Voltage Rank

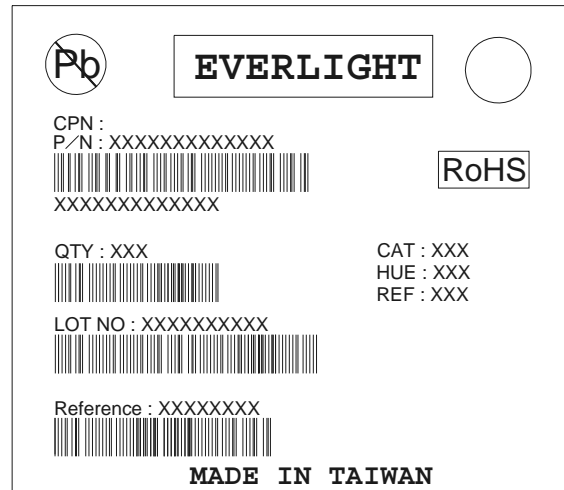

**Reel Dimensions**

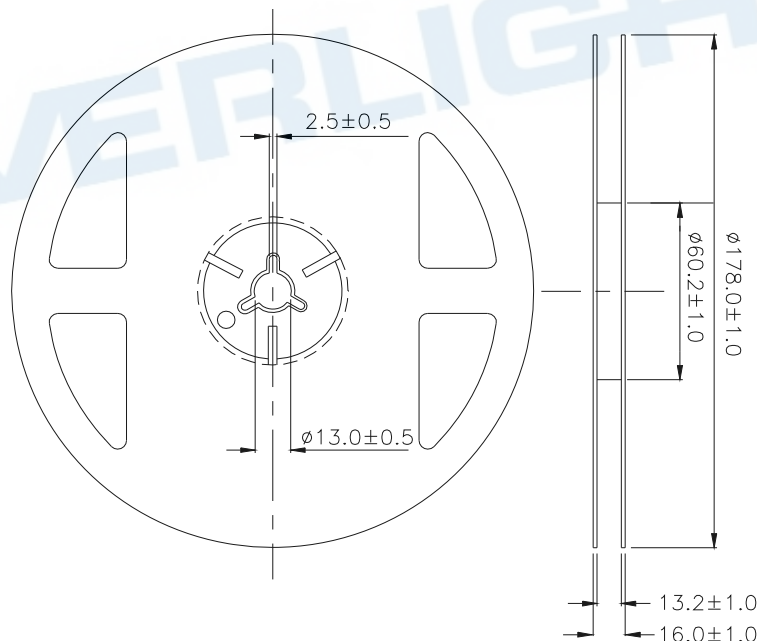

**Note:** Tolerances Unless Dimension  $\pm 0.1$ mm, Unit = mm



**Technical Data Sheet - Preliminary**

**Full Color Side View LEDs (Height 0.8mm)**

**99-235/RSGHB7C-A07/2D**

**Carrier Tape Dimensions: Loaded Quantity 2000 pcs Per Reel.**

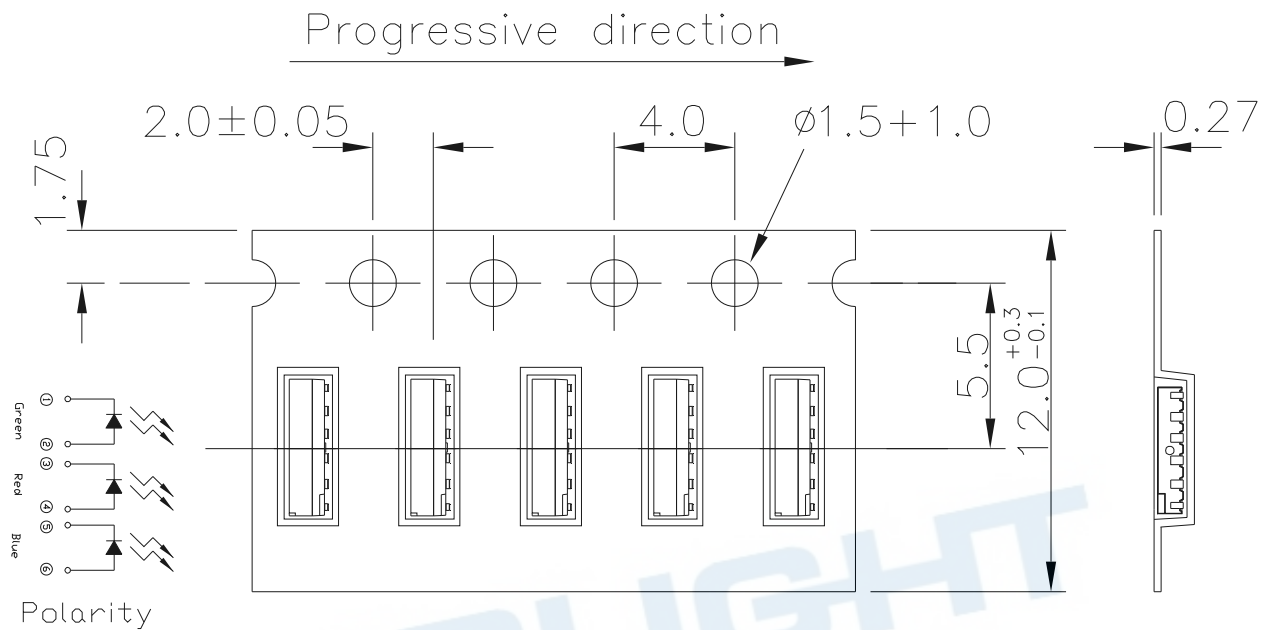

**Note:** Tolerances Unless Dimension ±0.1mm, Unit = mm

**Moisture Resistant Packaging**

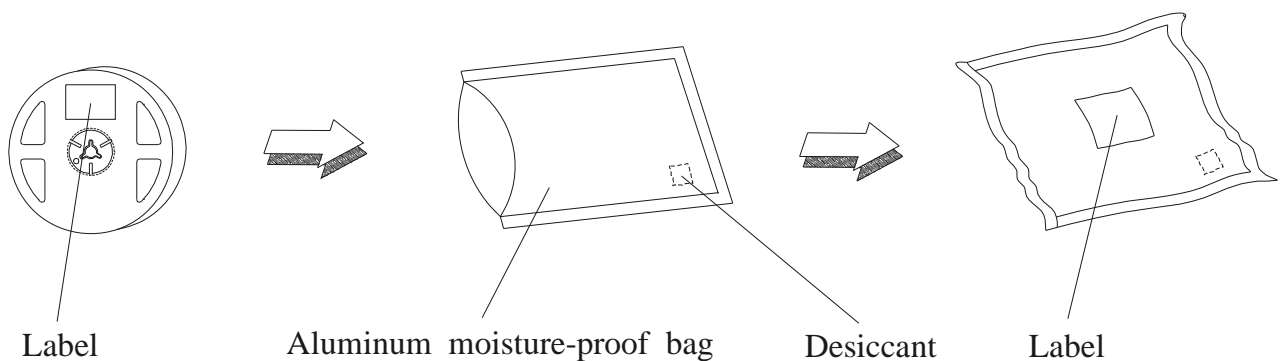

**Technical Data Sheet - Preliminary****Full Color Side View LEDs (Height 0.8mm)****99-235/RSGHB7C-A07/2D****Reliability Test Items and Conditions**

The reliability of products shall be satisfied with items listed below.

Confidence level : 90%

LTPD : 10%

No.	Items	Test Condition	Test Hours/Cycles	Sample Size	Ac/Re
1	Reflow Soldering	Temp. : 260°C±5°C Max. 10sec.	6 min	22 PCS.	0/1
2	Temperature Cycle	H : +100°C 15min ∫ 5 min L : -40°C 15min	300 Cycles	22 PCS.	0/1
3	Thermal Shock	H : +100°C 5min ∫ 10 sec L : -10°C 5min	300 Cycles	22 PCS.	0/1
4	High Temperature Storage	Temp. : 100°C	1000 Hrs.	22 PCS.	0/1
5	Low Temperature Storage	Temp. : -40°C	1000 Hrs.	22 PCS.	0/1
6	DC Operating Life	I <sub>F</sub> = 20 mA	1000 Hrs.	22 PCS.	0/1
7	High Temperature / High Humidity	85°C /RH85%	1000 Hrs.	22 PCS.	0/1

**Technical Data Sheet - Preliminary**

**Full Color Side View LEDs (Height 0.8mm)**

**99-235/RSGHB7C-A07/2D**

**Precautions for Use**

1. Over-current-proof

Customer must apply resistors for protection, otherwise slight voltage shift will cause big current change ( Burn out will happen ).

2. Storage

2.1 Do not open moisture proof bag before the products are ready to use.

2.2 Before opening the package: The LEDs should be kept at 30°C or less and 90%RH or less.

2.3 After opening the package: The LED's floor life are 168 hours under 30°C or less and 60% RH or less. If unused LEDs remain, it should be stored in moisture proof packages.

2.4 If the moisture absorbent material (silica gel) has faded away or the LEDs have exceeded the storage time, baking treatment should be performed using the following conditions.

Baking treatment : 60±5°C for 24 hours.

3. Soldering Condition

3.1 Pb-free solder temperature profile

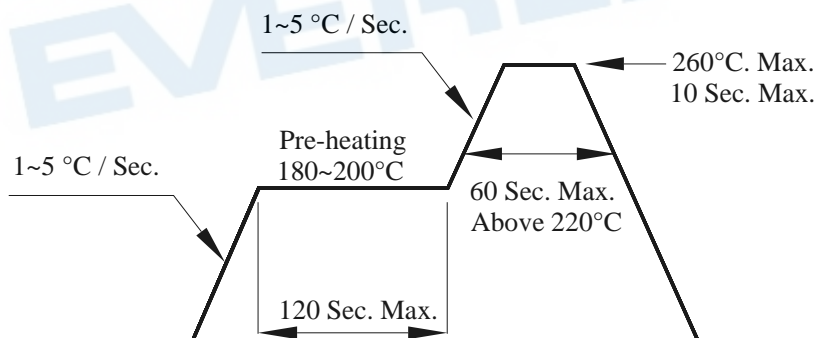

3.2 Reflow soldering should not be done more than two times.

3.3 When soldering, do not put stress on the LEDs during heating.

3.4 After soldering, do not warp the circuit board.

4. Soldering Iron

Each terminal is to go to the tip of soldering iron temperature less than 350°C for 3 seconds within once in less than the soldering iron capacity 25W. Leave two seconds and more intervals, and do soldering of each terminal. Be careful because the damage of the product is often started at the time of the hand solder.

**Technical Data Sheet - Preliminary**

**Full Color Side View LEDs (Height 0.8mm)**

**99-235/RSGHB7C-A07/2D**

5. Repairing

Repair should not be done after the LEDs have been soldered. When repairing is unavoidable, a double-head soldering iron should be used (as below figure). It should be confirmed beforehand whether the characteristics of the LEDs will or will not be damaged by repairing.

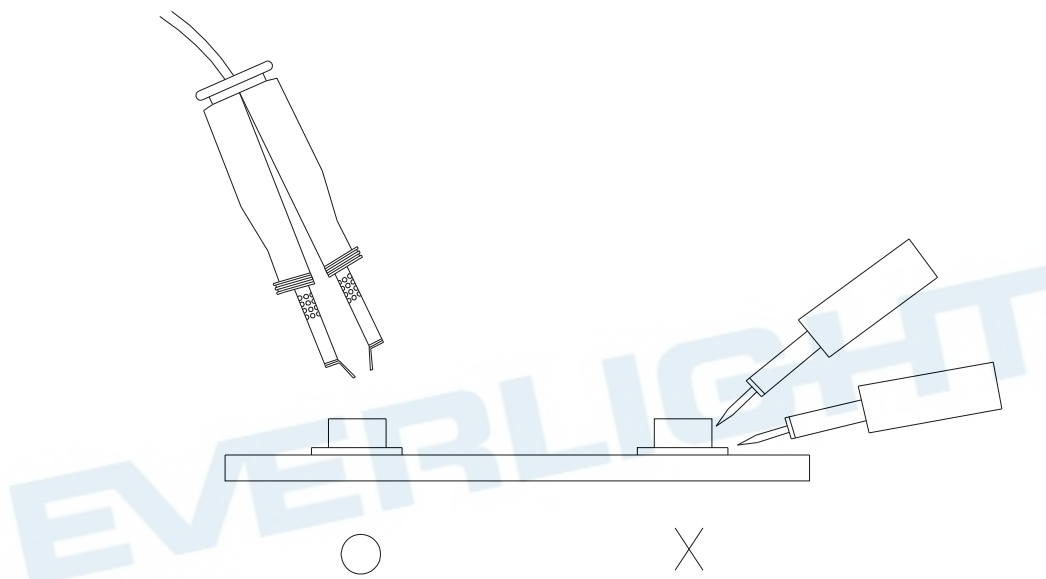

**Technical Data Sheet - Preliminary**

**Full Color Side View LEDs (Height 0.8mm)**

**99-235/RSGHB7C-A07/2D**

**DISCLAIMER**

1. EVERLIGHT reserves the right(s) on the adjustment of product material mix for the specification.
2. The product meets EVERLIGHT published specification for a period of twelve (12) months from date of shipment.
3. The graphs shown in this datasheet are representing typical data only and do not show guaranteed values.
4. When using this product, please observe the absolute maximum ratings and the instructions for using outlined in these specification sheets. EVERLIGHT assumes no responsibility for any damage resulting from the use of the product which does not comply with the absolute maximum ratings and the instructions included in these specification sheets.
5. These specification sheets include materials protected under copyright of EVERLIGHT. Reproduction in any form is prohibited without obtaining EVERLIGHT's prior consent.
6. This product is not intended to be used for military, aircraft, automotive, medical, life sustaining or life saving applications or any other application which can result in human injury or death. Please contact authorized Everlight sales agent for special application request.

**EVERLIGHT ELECTRONICS CO., LTD.**  
Office: No 25, Lane 76, Sec 3, Chung Yang Rd,  
Tucheng, Taipei 236, Taiwan, R.O.C

Tel: 886-2-2267-2000, 2267-9936  
Fax: 886-2267-6244, 2267-6189, 2267-6306  
<http://www.everlight.com>