

Features

- $\pm 0.5^{\circ}\text{C}$ Typical Threshold Accuracy
- $\pm 3.5^{\circ}\text{C}$ (max) Threshold Accuracy (0°C to $+125^{\circ}$)
- Temperature Threshold Set by a 1% External Resistor
- Low $40\mu\text{A}$ Supply Current
- Open-Drain Active Low Output Stage
- Guaranteed Reset Valid to $V_{\text{CC}} = 0.8\text{V}$
- Pin-Selectable 2°C or 10°C Hysteresis
- SOT-23-5 Packages

Applications

- μP Temperature Monitoring in High-Speed Computers
- Temperature Control
- Temperature Alarms
- Fan Control
- Automotive

General Description

The TP5709S5 are fully integrated, resistor programmable temperature switches with thresholds set by an external resistor. They require only one external resistor to set the temperature threshold within a wide 0°C to $+125^{\circ}\text{C}$ temperature range. The TP5709S5 provides an open-drain, active low output. These

switches operate with a $+2.7\text{V}$ to $+5.5\text{V}$ single supply while providing a temperature threshold accuracy of $\pm 0.5^{\circ}\text{C}$ (typ) or $\pm 3.5^{\circ}\text{C}$ (max). They typically consume $40\mu\text{A}$ supply current. Hysteresis is pin selectable to 2°C or 10°C .

Typical Application Circuit

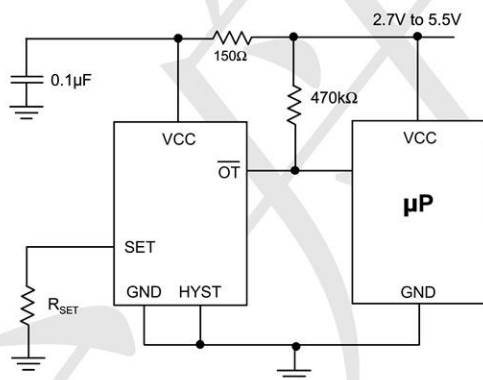

PIN CONFIGURATION

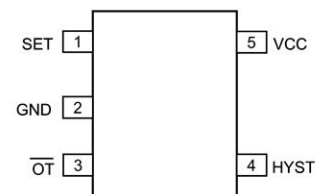

NAME	FUNCTION
SET	Temperature Set Point, Connect an external 1% resistor from SET to GND to set trip point.
GND	Ground
$\overline{\text{OT}}$	Open-Drain Active Low Output.
HYST	Hysteresis Selection. Hysteresis is 10°C for $\text{HYST} = V_{\text{CC}}$, 2°C for $\text{HYST} = \text{GND}$.
VCC	Power-Supply Input.

Features
BLOCK DIAGRAM

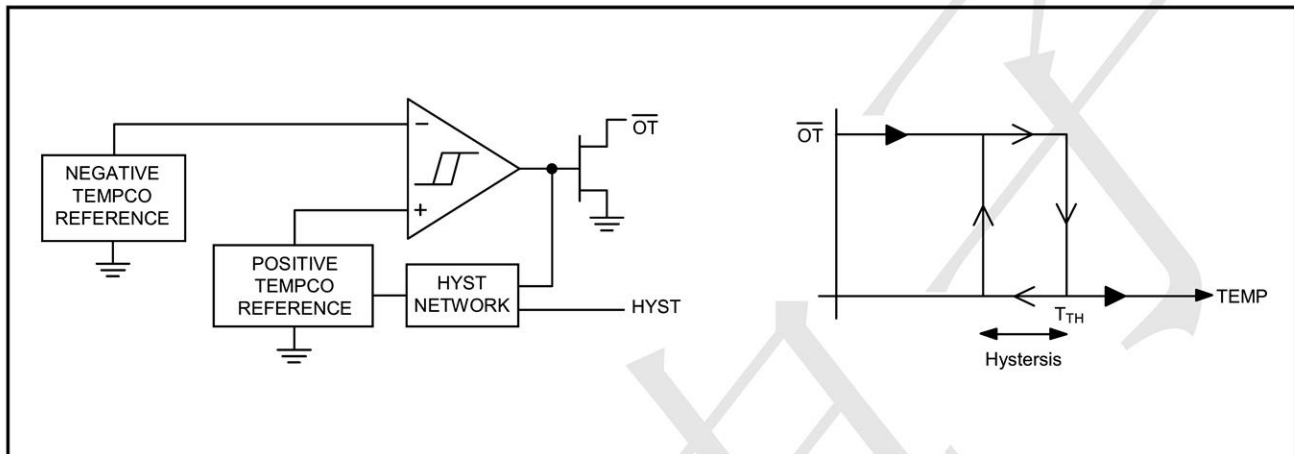

Absolute Maximum Ratings

Reference to GND Supply Voltage (V_{CC}) . . . -0.3V to +6V
 \overline{OT} -0.3V to +6V
 SET, HYST -0.3V to ($V_{CC} + 0.3V$)
 Output Current (all pins) 20mA
 Input Current (all pins) 20mA
 Thermal Resistance Junction to Ambient, (θ_{JA})
 SOT-23-5 240°C/W

Continuous Power Dissipation ($T_A = +25^\circ\text{C}$)
 SOT-23-5 520mW
 Operating Temperature Range -40°C to +125°C
 Junction Temperature +150°C
 Storage Temperature Range -65°C to +150°C
 Reflow Temperature (soldering, 10s) 260°C
 ESD Protection 2kV

Electrical Characteristics

$V_{CC} = +2.7V$ to $+5.5V$.

The device is not guaranteed to function outside its operating conditions. Parameters with MIN and/or MAX limits are 100% tested at +25°C, unless otherwise specified.

PARAMETER	SYMBOL	CONDITION	MIN	TYP	MAX	UNIT
Supply Voltage Range	V_{CC}		2.7	---	5.5	V
Supply Current	I_{CC}	$V_{CC}=3.3V$		40	55	μA
Temperature Threshold Accuracy	ΔT_{TH}	$T_A = 0^\circ\text{C}$ to $+125^\circ\text{C}$	-3.5	± 0.5	3.5	$^\circ\text{C}$
HYST Input Leakage			---	1	---	μA
HYST Input Threshold	V_{IH}		$0.7 \times V_{CC}$	---	---	V
	V_{IL}		---	---	$0.3 \times V_{CC}$	V
Open-Drain Output Sink Current	I_{OT}	$V_{\overline{OT}} = 0.3V$	5	12	---	mA
Open-Drain Output Leakage Current	I_{LEAK_OT}	$V_{\overline{OT}} = V_{CC}, V_{CC} = 0.5\text{--}5.5V$	---	1	---	μA



Typical Operating Characteristics

V_{CI}

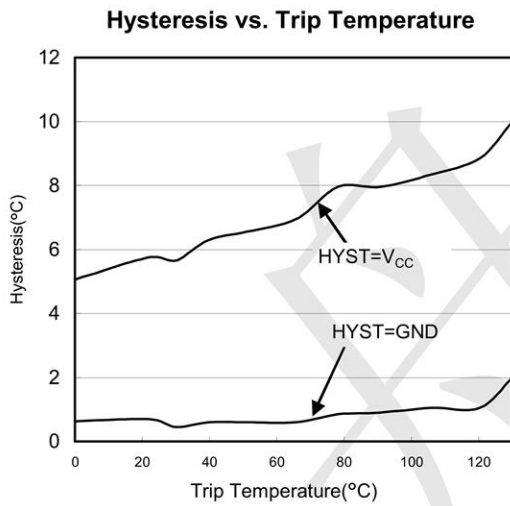
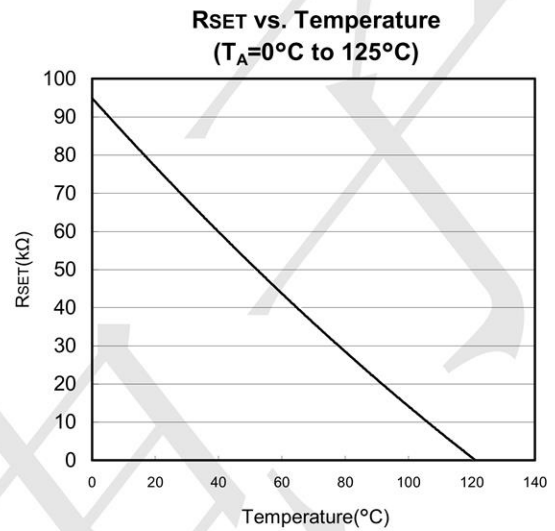
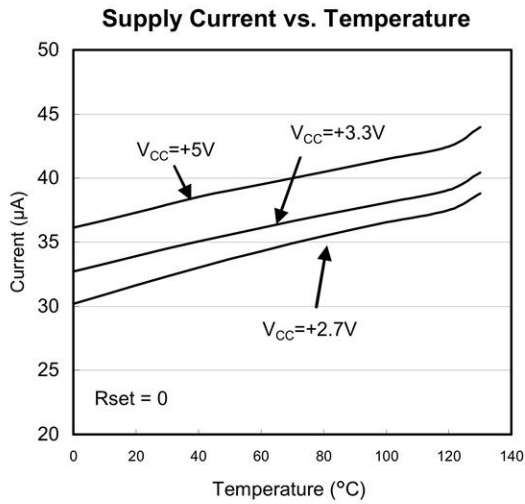

Detailed Description

The TP5709S5 fully integrated temperature switches incorporate two temperature-dependent references and one comparator. One reference exhibits a positive temperature coefficient, and the other has a negative temperature coefficient. The temperature at which the two reference voltages are equal determines the temperature trip point. Pin-selectable 2°C or 10°C hysteresis keeps the output from oscillating when the temperature is close to the threshold. The G709/G710 has an active-low, open-drain output structure.

The TP5709S5 are programmable for a wide range of temperature thresholds from 0°C to +125°C. The temperature threshold is set by an external resistor between SET and GND. The G709 output easily interfaces with a microprocessor (μP) reset input.

Hysteresis Input

The HYST pin is a CMOS-compatible input that selects hysteresis at either a high level (10°C for HYST = VCC) or a low level (2°C for HYST = GND). Hysteresis prevents the output from oscillating when the temperature is near the trip point. **Do not leave HYST unconnected.** Connect HYST to GND or VCC. Other input voltages cause increased supply current or abnormal function.

Applications Information

Set-Point Resistor

To set the trip-point temperature, connect a resistor between SET and GND. The resistor's value is determined either from the RSET vs. Temperature graphs (see *Typical Operating Characteristics*) or from the equations below.

To set the temperature trip point from 0°C to +125°C, use the following equation:

$$R_{\text{SET}}(\text{k}\Omega) = 0.0012T^2 - 0.9308T + 96.147$$

where T is the trip temperature in Centigrade. R_{SET} is the set-point resistance.

Thermal Considerations

The TP5709S5 supply current is typically 33 μA . When used to drive high-impedance loads, the devices dissipate negligible power; therefore, the die temperature is essentially the same as the package temperature. The key to accurate temperature monitoring is good thermal contact between the TP5709S5 package and the device being monitored. In some applications, the SOT-23 packages may be small enough to fit underneath a socketed μP , allowing the device to monitor the μP 's temperature directly. Use the monitor's output to reset the μP , assert an interrupt, or trigger an external alarm. Accurate temperature monitoring depends on the thermal resistance between the device being monitored and the G709/G710 die.

The rise in die temperature due to self-heating is given by the following formula:

$$\Delta T_J = P_{\text{DISS}} \times \theta_{\text{JA}}$$

where P_{DISS} is the power dissipated by the TP5709S5 and θ_{JA} is the package's thermal resistance. The typical thermal resistance is 115°C/W for the SOT-23 package. To limit the effects of self-heating, minimize the output currents.

Power Noise Filtering

To reduce trip point error caused by power noise, place a 150 Ω resistor and 0.1 μF capacitor as the low pass filter for V_{CC} .



Package information

SOT23-5

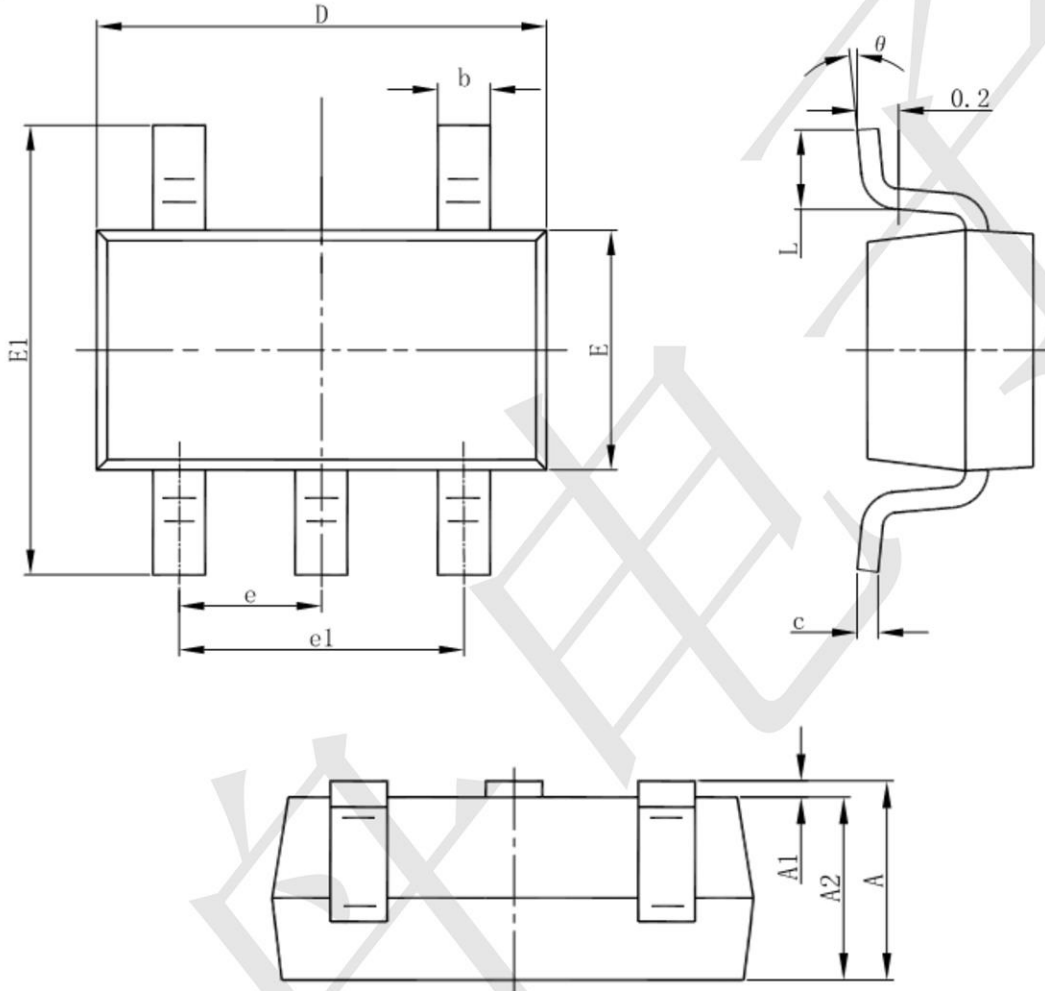

Symbol	Dimensions In Millimeters		Dimensions In Inches	
	Min	Max	Min	Max
A	1.050	1.250	0.041	0.049
A1	0.000	0.100	0.000	0.004
A2	1.050	1.150	0.041	0.045
b	0.300	0.500	0.012	0.020
c	0.100	0.200	0.004	0.008
D	2.820	3.020	0.111	0.119
E	1.500	1.700	0.059	0.067
E1	2.650	2.950	0.104	0.116
e	0.950(BSC)		0.037(BSC)	
e1	1.800	2.000	0.071	0.079
L	0.300	0.600	0.012	0.024
theta	0°	8°	0°	8°