

Prosperity Dielectrics Co., Ltd.

No.566-1, Kaoshi Rd., Yangmei, Taoyuan 32668, Taiwan (R.O.C.)

Tel : 886-3-4753355

Fax : 886-3-4854959

Messrs. : 一般共用

Date : 2020/04/29

APPROVAL SHEET

Product Name : Ultra High Q / Low ESR Multilayer Ceramic Chip Capacitors

Part No. : RF Series

Description : Size 01005~1111, C0G(NPO), 6.3V~1500V

PREPARED BY	APPROVED BY

信昌電子陶瓷股份有限公司

PROSPERITY DIELECTRICS CO., LTD.

桃園市楊梅區高獅路 566-1 號 <http://www.pdc.com.tw>

Tel : 03-4753355 ext :

Fax : 03-4854959

Contactor : _____ **Mobile :** _____

Prosperity Dielectrics Co., Ltd.

No.566-1, Kaoshi Rd., Yangmei, Taoyuan 32668, Taiwan (R.O.C.)

Tel : 886-3-4753355

Fax : 886-3-4854959

SPECIFICATION

FOR

Product Name : Ultra High Q / Low ESR Multilayer Ceramic Chip Capacitors

Part No. : RF Series

Description : Size 01005~1111, C0G(NPO), 6.3V~1500V

SPEC. No. : RF-000-001-05

DATE : 2020/04/29

DRAWN BY	CHECEKED BY	APPROVED BY
Jane Hsiao	Yvens Chou	Joseph Ling

1. INTRODUCTION

MLCC consists of a conducting material and electrodes. To manufacture a chip-type SMT and achieve miniaturization, high density and high efficiency, ceramic condensers are used.

PDC RF series MLCC is used at high frequencies generally have a small temperature coefficient of capacitance, typical within the $\pm 30\text{ppm}/^\circ\text{C}$ required for NP0 (COG) classification and have excellent conductivity internal electrode. Thus, PDC RF series MLCC will be with the feature of low ESR and high Q characteristics.

2. FEATURES

- a. High Q and low ESR performance at high frequency.
- b. Ultra low capacitance to 0.1pF.
- c. Can offer high precision tolerance to $\pm 0.05\text{pF}$.
- d. Quality improvement of telephone calls for low power loss and better performance.

3. APPLICATIONS

- a. Telecommunication products & equipments : Mobile phone, WLAN, Base station.
- b. RF module : Power amplifier, VCO.
- c. Tuners.

4. HOW TO ORDER

RF	21	N	101	J	251	C	I
Series	Size	Dielectric	Capacitance	Tolerance	Rated voltage	Termination	Packaging
RF=Ultra High Q & Low ESR	02=01005(0402) 03=0201 (0603) 11=0505 (1414) 15=0402 (1005) 18=0603 (1608) 21=0805 (2012) 22=1111 (2828)	N=NP0 (COG)	Two significant digits followed by no. of zeros. And R is in place of decimal point. eg.: 0R5=0.5pF 1R0=1.0pF 100=10x10 ⁰ =10pF	A= $\pm 0.05\text{pF}$ B= $\pm 0.1\text{pF}$ C= $\pm 0.25\text{pF}$ D= $\pm 0.5\text{pF}$ F= $\pm 1\%$ G= $\pm 2\%$ J= $\pm 5\%$	Two significant digits followed by no. of zeros. And R is in place of decimal point. 6R3=6.3 VDC 100=10 VDC 250=25 VDC 500=50 VDC 101=100 VDC 201=200 VDC 251=250 VDC 501=500 VDC 152=1500 VDC	C=Cu/Ni/Sn	T=7" reeled G= 13" reeled

5. EXTERNAL DIMENSIONS

Size Inch (mm)	L (mm)	W (mm)	T (mm)/Symbol	Remark	M _B (mm)
01005 (0402)	0.40±0.02	0.20±0.02	0.20±0.02	V #	0.10±0.03
0201 (0603)	0.60±0.03	0.30±0.03	0.30±0.03	L #	0.15±0.05
0402 (1005)	1.00±0.05	0.50±0.05	0.50±0.05	N #	0.25+0.05/-0.10
0603 (1608)	1.60±0.10	0.80±0.10	0.80±0.07	S	0.40±0.15
	1.60 +0.15/-0.10	0.80 +0.15/-0.10	0.50±0.10	H	
0805 (2012)	2.00±0.15	1.25±0.10	0.60±0.10	A	0.50±0.20
	2.00±0.20	1.25±0.20	0.85±0.10	T	
0505 (1414)	1.40+0.38/-0.25	1.40±0.38	1.15±0.15	J #	0.25+0.25/-0.13
1111 (2828)	2.79 +0.51/-0.25	2.79±0.38	≤ 1.78	G #	0.38±0.25

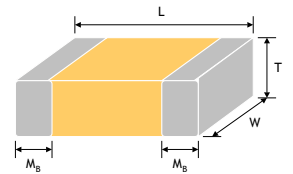

Fig. 5.1 The outline of MLCC

Reflow soldering only is recommended.

6. GENERAL ELECTRICAL DATA

Dielectric	NP0
Size	01005, 0201, 0402, 0505, 0603, 0805, 1111
Capacitance*	0.1pF to 1000pF
Capacitance tolerance	Cap.≤5pF : A (±0.05pF), B (±0.1pF), C (±0.25pF) 5pF<Cap.<10pF : B (±0.1pF), C (±0.25pF), D (±0.5pF) Cap.≥10pF : F (±1%), G (±2%), J (±5%)
Rated voltage (WVDC)	6.3V, 10V, 25V, 50V, 100V, 200V, 250V, 500V, 1500V
Q*	01005, 0201, 0402/25V~50V : Cap.<30pF : Q≥400+20C; Cap.≥30pF : Q≥1000 0402/100V~200V, 0603, 0805, 0505, 1111 : Cap.<30pF : Q≥800+20C; Cap.≥30pF : Q≥1400
Insulation resistance at Ur	≥10GΩ or RxC≥100Ω-F, whichever is smaller
Operating temperature	-55 to +125°C
Capacitance change	±30ppm/°C
Termination	Ni/Sn (lead-free termination)

* Measured at the conditions of 25°C ambient temperature and 30~70% related humidity.
 Apply 1.0±0.2Vrms, 1.0MHz±10% for Cap.≤1000pF and 1.0±0.2Vrms, 1.0kHz±10% for Cap.>1000pF.

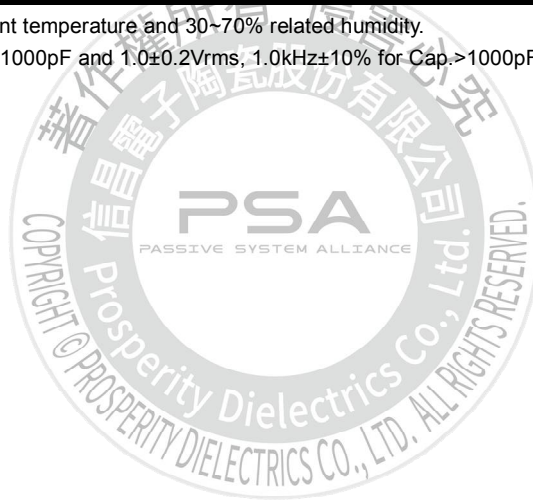

7. CAPACITANCE RANGE

DIELECTRIC		NP0		
SIZE		01005		Tolerance
RATED VOLTAGE (VDC)		16	25	
Capacitance	0.2pF (0R2)	V	V	A, B
	0.3pF (0R3)	V	V	A, B
	0.4pF (0R4)	V	V	A, B
	0.5pF (0R5)	V	V	A, B, C
	0.6pF (0R6)	V	V	A, B, C
	0.7pF (0R7)	V	V	A, B, C
	0.75pF (R75)	V	V	A, B, C
	0.8pF (0R8)	V	V	A, B, C
	0.9pF (0R9)	V	V	A, B, C
	1.0pF (1R0)	V	V	A, B, C
	1.2pF (1R2)	V	V	A, B, C
	1.5pF (1R5)	V	V	A, B, C
	1.8pF (1R8)	V	V	A, B, C
	2.0pF (2R0)	V	V	A, B, C
	2.2pF (2R2)	V	V	A, B, C
	2.7pF (2R7)	V	V	A, B, C
	3.0pF (3R0)	V	V	A, B, C
	3.3pF (3R3)	V	V	A, B, C
	3.9pF (3R9)	V	V	A, B, C
	4.0pF (4R0)	V	V	A, B, C
	4.7pF (4R7)	V	V	A, B, C
	5.0pF (5R0)	V	V	A, B, C
5.6pF (5R6)	V	V	B, C, D	
6.0pF (6R0)	V	V	B, C, D	
6.8pF (6R8)	V	V	B, C, D	
7.0pF (7R0)	V	V	B, C, D	
8.0pF (8R0)	V	V	B, C, D	
8.2pF (8R2)	V	V	B, C, D	
9.0pF (9R0)	V	V	B, C, D	
10pF (100)	V	V	C, D, G	
12pF (120)	V	V	J	
15pF (150)	V	V	J	
20pF (200)	V	V	J	
22pF (220)	V	V	J	

1. The letter in cell is expressed the symbol of product thickness.
2. For more information about products with special capacitance or other data, please contact PDC local representative.

7. CAPACITANCE RANGE(Con.)

DIELECTRIC		NP0									Tolerance
SIZE		0201					0402				
RATED VOLTAGE (VDC)		6.3	10	25	50	100	25	50	100	200	
Capacitance	0.1pF (0R1)	L	L	L	L	L	N	N	N	N	A, B
	0.2pF (0R2)	L	L	L	L	L	N	N	N	N	A, B
	0.3pF (0R3)	L	L	L	L	L	N	N	N	N	A, B
	0.4pF (0R4)	L	L	L	L	L	N	N	N	N	A, B
	0.5pF (0R5)	L	L	L	L	L	N	N	N	N	A, B, C
	0.6pF (0R6)	L	L	L	L	L	N	N	N	N	A, B, C
	0.7pF (0R7)	L	L	L	L	L	N	N	N	N	A, B, C
	0.75pF (R75)	L	L	L	L	L	N	N	N	N	A, B, C
	0.8pF (0R8)	L	L	L	L	L	N	N	N	N	A, B, C
	0.9pF (0R9)	L	L	L	L	L	N	N	N	N	A, B, C
	1.0pF (1R0)	L	L	L	L	L	N	N	N	N	A, B, C
	1.1pF (1R1)	L	L	L	L	L	N	N	N	N	A, B, C
	1.2pF (1R2)	L	L	L	L	L	N	N	N	N	A, B, C
	1.3pF (1R3)	L	L	L	L	L	N	N	N	N	A, B, C
	1.4pF (1R4)	L	L	L	L	L	N	N	N	N	A, B, C
	1.5pF (1R5)	L	L	L	L	L	N	N	N	N	A, B, C
	1.6pF (1R6)	L	L	L	L	L	N	N	N	N	A, B, C
	1.7pF (1R7)	L	L	L	L	L	N	N	N	N	A, B, C
	1.8pF (1R8)	L	L	L	L	L	N	N	N	N	A, B, C
	1.9pF (1R9)	L	L	L	L	L	N	N	N	N	A, B, C
	2.0pF (2R0)	L	L	L	L	L	N	N	N	N	A, B, C
	2.1pF (2R1)	L	L	L	L	L	N	N	N	N	A, B, C
	2.2pF (2R2)	L	L	L	L	L	N	N	N	N	A, B, C
	2.3pF (2R3)	L	L	L	L	L	N	N	N	N	A, B, C
	2.4pF (2R4)	L	L	L	L	L	N	N	N	N	A, B, C
	2.5pF (2R5)	L	L	L	L	L	N	N	N	N	A, B, C
	2.6pF (2R6)	L	L	L	L	L	N	N	N	N	A, B, C
	2.7pF (2R7)	L	L	L	L	L	N	N	N	N	A, B, C
	2.8pF (2R8)	L	L	L	L	L	N	N	N	N	A, B, C
	2.9pF (2R9)	L	L	L	L	L	N	N	N	N	A, B, C
	3.0pF (3R0)	L	L	L	L	L	N	N	N	N	A, B, C
	3.1pF (3R1)	L	L	L	L	L	N	N	N	N	A, B, C
	3.2pF (3R2)	L	L	L	L	L	N	N	N	N	A, B, C
	3.3pF (3R3)	L	L	L	L	L	N	N	N	N	A, B, C
	3.4pF (3R4)	L	L	L	L	L	N	N	N	N	A, B, C
	3.5pF (3R5)	L	L	L	L	L	N	N	N	N	A, B, C
	3.6pF (3R6)	L	L	L	L	L	N	N	N	N	A, B, C
	3.7pF (3R7)	L	L	L	L	L	N	N	N	N	A, B, C
	3.8pF (3R8)	L	L	L	L	L	N	N	N	N	A, B, C
	3.9pF (3R9)	L	L	L	L	L	N	N	N	N	A, B, C
	4.0pF (4R0)	L	L	L	L	L	N	N	N	N	A, B, C
	4.1pF (4R1)	L	L	L	L	L	N	N	N	N	A, B, C
	4.2pF (4R2)	L	L	L	L	L	N	N	N	N	A, B, C
	4.3pF (4R3)	L	L	L	L	L	N	N	N	N	A, B, C
	4.4pF (4R4)	L	L	L	L	L	N	N	N	N	A, B, C
	4.5pF (4R5)	L	L	L	L	L	N	N	N	N	A, B, C
	4.6pF (4R6)	L	L	L	L	L	N	N	N	N	A, B, C
	4.7pF (4R7)	L	L	L	L	L	N	N	N	N	A, B, C
	4.8pF (4R8)	L	L	L	L	L	N	N	N	N	A, B, C
	4.9pF (4R9)	L	L	L	L	L	N	N	N	N	A, B, C
	5.0pF (5R0)	L	L	L	L	L	N	N	N	N	A, B, C
	5.1pF (5R1)	L	L	L	L	L	N	N	N	N	B, C, D
	5.2pF (5R2)	L	L	L	L	L	N	N	N	N	B, C, D
	5.3pF (5R3)	L	L	L	L	L	N	N	N	N	B, C, D
	5.4pF (5R4)	L	L	L	L	L	N	N	N	N	B, C, D
	5.5pF (5R5)	L	L	L	L	L	N	N	N	N	B, C, D
	5.6pF (5R6)	L	L	L	L	L	N	N	N	N	B, C, D
	5.7pF (5R7)	L	L	L	L	L	N	N	N	N	B, C, D
	5.8pF (5R8)	L	L	L	L	L	N	N	N	N	B, C, D
	5.9pF (5R9)	L	L	L	L	L	N	N	N	N	B, C, D
6.0pF (6R0)	L	L	L	L	L	N	N	N	N	B, C, D	

1. The letter in cell is expressed the symbol of product thickness.
2. For more information about products with special capacitance or other data, please contact PDC local representative.

7. CAPACITANCE RANGE(Con.)

DIELECTRIC		NP0									Tolerance
SIZE		0201					0402				
RATED VOLTAGE (VDC)		6.3	10	25	50	100	25	50	100	200	
Capacitance	6.1pF (6R1)	L	L	L	L	L	N	N	N	N	B, C, D
	6.2pF (6R2)	L	L	L	L	L	N	N	N	N	B, C, D
	6.3pF (6R3)	L	L	L	L	L	N	N	N	N	B, C, D
	6.4pF (6R4)	L	L	L	L	L	N	N	N	N	B, C, D
	6.5pF (6R5)	L	L	L	L	L	N	N	N	N	B, C, D
	6.6pF (6R6)	L	L	L	L	L	N	N	N	N	B, C, D
	6.7pF (6R7)	L	L	L	L	L	N	N	N	N	B, C, D
	6.8pF (6R8)	L	L	L	L	L	N	N	N	N	B, C, D
	6.9pF (6R9)	L	L	L	L	L	N	N	N	N	B, C, D
	7.0pF (7R0)	L	L	L	L	L	N	N	N	N	B, C, D
	7.1pF (7R1)	L	L	L	L	L	N	N	N	N	B, C, D
	7.2pF (7R2)	L	L	L	L	L	N	N	N	N	B, C, D
	7.3pF (7R3)	L	L	L	L	L	N	N	N	N	B, C, D
	7.4pF (7R4)	L	L	L	L	L	N	N	N	N	B, C, D
	7.5pF (7R5)	L	L	L	L	L	N	N	N	N	B, C, D
	7.6pF (7R6)	L	L	L	L	L	N	N	N	N	B, C, D
	7.7pF (7R7)	L	L	L	L	L	N	N	N	N	B, C, D
	7.8pF (7R8)	L	L	L	L	L	N	N	N	N	B, C, D
	7.9pF (7R9)	L	L	L	L	L	N	N	N	N	B, C, D
	8.0pF (8R0)	L	L	L	L	L	N	N	N	N	B, C, D
	8.1pF (8R1)	L	L	L	L	L	N	N	N	N	B, C, D
	8.2pF (8R2)	L	L	L	L	L	N	N	N	N	B, C, D
	8.3pF (8R3)	L	L	L	L	L	N	N	N	N	B, C, D
	8.4pF (8R4)	L	L	L	L	L	N	N	N	N	B, C, D
	8.5pF (8R5)	L	L	L	L	L	N	N	N	N	B, C, D
	8.6pF (8R6)	L	L	L	L	L	N	N	N	N	B, C, D
	8.7pF (8R7)	L	L	L	L	L	N	N	N	N	B, C, D
	8.8pF (8R8)	L	L	L	L	L	N	N	N	N	B, C, D
	8.9pF (8R9)	L	L	L	L	L	N	N	N	N	B, C, D
	9.0pF (9R0)	L	L	L	L	L	N	N	N	N	B, C, D
	9.1pF (9R1)	L	L	L	L	L	N	N	N	N	B, C, D
	9.2pF (9R2)	L	L	L	L	L	N	N	N	N	B, C, D
	9.3pF (9R3)	L	L	L	L	L	N	N	N	N	B, C, D
	9.4pF (9R4)	L	L	L	L	L	N	N	N	N	B, C, D
	9.5pF (9R5)	L	L	L	L	L	N	N	N	N	B, C, D
	9.6pF (9R6)	L	L	L	L	L	N	N	N	N	B, C, D
	9.7pF (9R7)	L	L	L	L	L	N	N	N	N	B, C, D
	9.8pF (9R8)	L	L	L	L	L	N	N	N	N	B, C, D
	9.9pF (9R9)	L	L	L	L	L	N	N	N	N	B, C, D
	10pF (100)	L	L	L	L	L	N	N	N	N	F, G, J
11pF (110)	L	L	L	L	L	N	N	N	N	F, G, J	
12pF (120)	L	L	L	L	L	N	N	N	N	F, G, J	
13pF (130)	L	L	L	L	L	N	N	N	N	F, G, J	
15pF (150)	L	L	L	L	L	N	N	N	N	F, G, J	
16pF (160)	L	L	L	L	L	N	N	N	N	F, G, J	
18pF (180)	L	L	L	L	L	N	N	N	N	F, G, J	
20pF (200)	L	L	L	L	L	N	N	N	N	F, G, J	
22pF (220)	L	L	L	L	L	N	N	N	N	F, G, J	
24pF (240)	L	L	L	L	L	N	N	N	N	F, G, J	
27pF (270)	L	L	L	L	L	N	N	N	N	F, G, J	
30pF (300)	L	L	L	L	L	N	N	N	N	F, G, J	
33pF (330)	L	L	L	L	L	N	N	N	N	F, G, J	
36pF (360)						N	N	N	N	F, G, J	
39pF (390)						N	N	N	N	F, G, J	
43pF (430)						N	N	N	N	F, G, J	
47pF (470)						N	N	N	N	F, G, J	
56pF (560)						N	N	N	N	F, G, J	
68pF (680)						N	N	N	N	F, G, J	
82pF (820)						N	N	N	N	F, G, J	
100pF (101)						N	N	N	N	F, G, J	

1. The letter in cell is expressed the symbol of product thickness.

2. For more information about products with special capacitance or other data, please contact PDC local representative.

7. CAPACITANCE RANGE(Con.)

DIELECTRIC		NP0										Tolerance
SIZE		0505			0603			0805				
RATED VOLTAGE (VDC)		50	100	250	50	100	250	50	100	250	500	
Capacitance	0.1pF (0R1)				H	H	H					A, B
	0.2pF (0R2)				H	H	H	A	A	A	A	A, B
	0.3pF (0R3)				S	S	S	T	T	T	T	A, B
	0.4pF (0R4)	J	J	J	S	S	S	T	T	T	T	A, B
	0.5pF (0R5)	J	J	J	S	S	S	T	T	T	T	A, B, C
	0.6pF (0R6)	J	J	J	S	S	S	T	T	T	T	A, B, C
	0.7pF (0R7)	J	J	J	S	S	S	T	T	T	T	A, B, C
	0.8pF (0R8)	J	J	J	S	S	S	T	T	T	T	A, B, C
	0.9pF (0R9)	J	J	J	S	S	S	T	T	T	T	A, B, C
	1.0pF (1R0)	J	J	J	S	S	S	T	T	T	T	A, B, C
	1.1pF (1R1)	J	J	J	S	S	S	T	T	T	T	A, B, C
	1.2pF (1R2)	J	J	J	S	S	S	T	T	T	T	A, B, C
	1.3pF (1R3)	J	J	J	S	S	S	T	T	T	T	A, B, C
	1.4pF (1R4)	J	J	J	S	S	S	T	T	T	T	A, B, C
	1.5pF (1R5)	J	J	J	S	S	S	T	T	T	T	A, B, C
	1.6pF (1R6)	J	J	J	S	S	S	T	T	T	T	A, B, C
	1.7pF (1R7)	J	J	J	S	S	S	T	T	T	T	A, B, C
	1.8pF (1R8)	J	J	J	S	S	S	T	T	T	T	A, B, C
	1.9pF (1R9)	J	J	J	S	S	S	T	T	T	T	A, B, C
	2.0pF (2R0)	J	J	J	S	S	S	T	T	T	T	A, B, C
	2.1pF (2R1)	J	J	J	S	S	S	T	T	T	T	A, B, C
	2.2pF (2R2)	J	J	J	S	S	S	T	T	T	T	A, B, C
	2.3pF (2R3)	J	J	J	S	S	S	T	T	T	T	A, B, C
	2.4pF (2R4)	J	J	J	S	S	S	T	T	T	T	A, B, C
	2.5pF (2R5)	J	J	J	S	S	S	T	T	T	T	A, B, C
	2.6pF (2R6)	J	J	J	S	S	S	T	T	T	T	A, B, C
	2.7pF (2R7)	J	J	J	S	S	S	T	T	T	T	A, B, C
	2.8pF (2R8)	J	J	J	S	S	S	T	T	T	T	A, B, C
	2.9pF (2R9)	J	J	J	S	S	S	T	T	T	T	A, B, C
	3.0pF (3R0)	J	J	J	S	S	S	T	T	T	T	A, B, C
	3.1pF (3R1)	J	J	J	S	S	S	T	T	T	T	A, B, C
	3.2pF (3R2)	J	J	J	S	S	S	T	T	T	T	A, B, C
	3.3pF (3R3)	J	J	J	S	S	S	T	T	T	T	A, B, C
	3.4pF (3R4)	J	J	J	S	S	S	T	T	T	T	A, B, C
	3.5pF (3R5)	J	J	J	S	S	S	T	T	T	T	A, B, C
	3.6pF (3R6)	J	J	J	S	S	S	T	T	T	T	A, B, C
3.7pF (3R7)	J	J	J	S	S	S	T	T	T	T	A, B, C	
3.8pF (3R8)	J	J	J	S	S	S	T	T	T	T	A, B, C	
3.9pF (3R9)	J	J	J	S	S	S	T	T	T	T	A, B, C	
4.0pF (4R0)	J	J	J	S	S	S	T	T	T	T	A, B, C	
4.1pF (4R1)	J	J	J	S	S	S	T	T	T	T	A, B, C	
4.2pF (4R2)	J	J	J	S	S	S	T	T	T	T	A, B, C	
4.3pF (4R3)	J	J	J	S	S	S	T	T	T	T	A, B, C	
4.4pF (4R4)	J	J	J	S	S	S	T	T	T	T	A, B, C	
4.5pF (4R5)	J	J	J	S	S	S	T	T	T	T	A, B, C	
4.6pF (4R6)	J	J	J	S	S	S	T	T	T	T	A, B, C	
4.7pF (4R7)	J	J	J	S	S	S	T	T	T	T	A, B, C	
4.8pF (4R8)	J	J	J	S	S	S	T	T	T	T	A, B, C	
4.9pF (4R9)	J	J	J	S	S	S	T	T	T	T	A, B, C	
5.0pF (5R0)	J	J	J	S	S	S	T	T	T	T	A, B, C	
5.1pF (5R1)	J	J	J	S	S	S	T	T	T	T	B, C, D	
5.2pF (5R2)	J	J	J	S	S	S	T	T	T	T	B, C, D	
5.3pF (5R3)	J	J	J	S	S	S	T	T	T	T	B, C, D	
5.4pF (5R4)	J	J	J	S	S	S	T	T	T	T	B, C, D	
5.5pF (5R5)	J	J	J	S	S	S	T	T	T	T	B, C, D	
5.6pF (5R6)	J	J	J	S	S	S	T	T	T	T	B, C, D	
5.7pF (5R7)	J	J	J	S	S	S	T	T	T	T	B, C, D	
5.8pF (5R8)	J	J	J	S	S	S	T	T	T	T	B, C, D	
5.9pF (5R9)	J	J	J	S	S	S	T	T	T	T	B, C, D	
6.0pF (6R0)	J	J	J	S	S	S	T	T	T	T	B, C, D	

1. The letter in cell is expressed the symbol of product thickness.

2. For more information about products with special capacitance or other data, please contact PDC local representative.

7. CAPACITANCE RANGE(Con.)

DIELECTRIC		NPO											Tolerance
SIZE		0505			0603				0805				
RATED VOLTAGE (VDC)		50	100	250	25	50	100	250	50	100	250	500	
Capacitance	6.1pF (6R1)	J	J	J	S	S	S	S	T	T	T	T	B, C, D
	6.2pF (6R2)	J	J	J	S	S	S	S	T	T	T	T	B, C, D
	6.3pF (6R3)	J	J	J	S	S	S	S	T	T	T	T	B, C, D
	6.4pF (6R4)	J	J	J	S	S	S	S	T	T	T	T	B, C, D
	6.5pF (6R5)	J	J	J	S	S	S	S	T	T	T	T	B, C, D
	6.6pF (6R6)	J	J	J	S	S	S	S	T	T	T	T	B, C, D
	6.7pF (6R7)	J	J	J	S	S	S	S	T	T	T	T	B, C, D
	6.8pF (6R8)	J	J	J	S	S	S	S	T	T	T	T	B, C, D
	6.9pF (6R9)	J	J	J	S	S	S	S	T	T	T	T	B, C, D
	7.0pF (7R0)	J	J	J	S	S	S	S	T	T	T	T	B, C, D
	7.1pF (7R1)	J	J	J	S	S	S	S	T	T	T	T	B, C, D
	7.2pF (7R2)	J	J	J	S	S	S	S	T	T	T	T	B, C, D
	7.3pF (7R3)	J	J	J	S	S	S	S	T	T	T	T	B, C, D
	7.4pF (7R4)	J	J	J	S	S	S	S	T	T	T	T	B, C, D
	7.5pF (7R5)	J	J	J	S	S	S	S	T	T	T	T	B, C, D
	7.6pF (7R6)	J	J	J	S	S	S	S	T	T	T	T	B, C, D
	7.7pF (7R7)	J	J	J	S	S	S	S	T	T	T	T	B, C, D
	7.8pF (7R8)	J	J	J	S	S	S	S	T	T	T	T	B, C, D
	7.9pF (7R9)	J	J	J	S	S	S	S	T	T	T	T	B, C, D
	8.0pF (8R0)	J	J	J	S	S	S	S	T	T	T	T	B, C, D
	8.1pF (8R1)	J	J	J	S	S	S	S	T	T	T	T	B, C, D
	8.2pF (8R2)	J	J	J	S	S	S	S	T	T	T	T	B, C, D
	8.3pF (8R3)	J	J	J	S	S	S	S	T	T	T	T	B, C, D
	8.4pF (8R4)	J	J	J	S	S	S	S	T	T	T	T	B, C, D
	8.5pF (8R5)	J	J	J	S	S	S	S	T	T	T	T	B, C, D
	8.6pF (8R6)	J	J	J	S	S	S	S	T	T	T	T	B, C, D
	8.7pF (8R7)	J	J	J	S	S	S	S	T	T	T	T	B, C, D
	8.8pF (8R8)	J	J	J	S	S	S	S	T	T	T	T	B, C, D
	8.9pF (8R9)	J	J	J	S	S	S	S	T	T	T	T	B, C, D
	9.0pF (9R0)	J	J	J	S	S	S	S	T	T	T	T	B, C, D
	9.1pF (9R1)	J	J	J	S	S	S	S	T	T	T	T	B, C, D
	9.2pF (9R2)	J	J	J	S	S	S	S	T	T	T	T	B, C, D
	9.3pF (9R3)	J	J	J	S	S	S	S	T	T	T	T	B, C, D
	9.4pF (9R4)	J	J	J	S	S	S	S	T	T	T	T	B, C, D
	9.5pF (9R5)	J	J	J	S	S	S	S	T	T	T	T	B, C, D
	9.6pF (9R6)	J	J	J	S	S	S	S	T	T	T	T	B, C, D
	9.7pF (9R7)	J	J	J	S	S	S	S	T	T	T	T	B, C, D
	9.8pF (9R8)	J	J	J	S	S	S	S	T	T	T	T	B, C, D
	9.9pF (9R9)	J	J	J	S	S	S	S	T	T	T	T	B, C, D
	10pF (100)	J	J	J	S	S	S	S	T	T	T	T	F, G, J
	11pF (110)	J	J	J	S	S	S	S	T	T	T	T	F, G, J
	12pF (120)	J	J	J	S	S	S	S	T	T	T	T	F, G, J
13pF (130)	J	J	J	S	S	S	S	T	T	T	T	F, G, J	
15pF (150)	J	J	J	S	S	S	S	T	T	T	T	F, G, J	
16pF (160)	J	J	J	S	S	S	S	T	T	T	T	F, G, J	
18pF (180)	J	J	J	S	S	S	S	T	T	T	T	F, G, J	
20pF (200)	J	J	J	S	S	S	S	T	T	T	T	F, G, J	
22pF (220)	J	J	J	S	S	S	S	T	T	T	T	F, G, J	
24pF (240)	J	J	J	S	S	S	S	T	T	T	T	F, G, J	
27pF (270)	J	J	J	S	S	S	S	T	T	T	T	F, G, J	
30pF (300)	J	J	J	S	S	S	S	T	T	T	T	F, G, J	
33pF (330)	J	J	J	S	S	S	S	T	T	T	T	F, G, J	
36pF (360)	J	J	J	S	S	S	S	T	T	T	T	F, G, J	
39pF (390)	J	J	J	S	S	S	S	T	T	T	T	F, G, J	
43pF (430)	J	J	J	S	S	S	S	T	T	T	T	F, G, J	
47pF (470)	J	J	J	S	S	S	S	T	T	T	T	F, G, J	
56pF (560)	J	J	J	S	S	S	S	T	T	T	T	F, G, J	
68pF (680)	J	J	J	S	S	S	S	T	T	T	T	F, G, J	
82pF (820)	J	J	J	S	S	S	S	T	T	T	T	F, G, J	
100pF (101)	J	J	J	S	S	S	S	T	T	T	T	F, G, J	
120pF (121)				S	S			T	T	T		F, G, J	
150pF (151)				S	S			T	T	T		F, G, J	
180pF (181)				S	S			T	T	T		F, G, J	
220pF (221)				S	S			T	T	T		F, G, J	

- The letter in cell is expressed the symbol of product thickness.
- For more information about products with special capacitance or other data, please contact PDC local representative.

7. CAPACITANCE RANGE(Con.)

DIELECTRIC		NPO						Tolerance
SIZE		1111						
RATED VOLTAGE (VDC)	50	100	200	250	500	1500		
Capacitance	1.0pF (1R0)	G	G	G	G	G	G	A, B, C
	1.1pF (1R1)	G	G	G	G	G	G	A, B, C
	1.2pF (1R2)	G	G	G	G	G	G	A, B, C
	1.3pF (1R3)	G	G	G	G	G	G	A, B, C
	1.5pF (1R5)	G	G	G	G	G	G	A, B, C
	1.6pF (1R6)	G	G	G	G	G	G	A, B, C
	1.8pF (1R8)	G	G	G	G	G	G	A, B, C
	2.0pF (2R0)	G	G	G	G	G	G	A, B, C
	2.2pF (2R2)	G	G	G	G	G	G	A, B, C
	2.4pF (2R4)	G	G	G	G	G	G	A, B, C
	2.7pF (2R7)	G	G	G	G	G	G	A, B, C
	3.0pF (3R0)	G	G	G	G	G	G	A, B, C
	3.3pF (3R3)	G	G	G	G	G	G	A, B, C
	3.6pF (3R6)	G	G	G	G	G	G	A, B, C
	3.9pF (3R9)	G	G	G	G	G	G	A, B, C
	4.0pF (4R0)	G	G	G	G	G	G	A, B, C
	4.3pF (4R3)	G	G	G	G	G	G	A, B, C
	5.0pF (5R0)	G	G	G	G	G	G	A, B, C
	5.1pF (5R1)	G	G	G	G	G	G	B, C, D
	5.6pF (5R6)	G	G	G	G	G	G	B, C, D
	6.0pF (6R0)	G	G	G	G	G	G	B, C, D
	6.8pF (6R8)	G	G	G	G	G	G	B, C, D
	7.0pF (7R0)	G	G	G	G	G	G	B, C, D
	8.0pF (8R0)	G	G	G	G	G	G	B, C, D
	8.2pF (8R2)	G	G	G	G	G	G	B, C, D
	10pF (100)	G	G	G	G	G	G	F, G, J
	12pF (120)	G	G	G	G	G	G	F, G, J
	15pF (150)	G	G	G	G	G	G	F, G, J
	18pF (180)	G	G	G	G	G	G	F, G, J
	22pF (220)	G	G	G	G	G	G	F, G, J
	27pF (270)	G	G	G	G	G	G	F, G, J
	33pF (330)	G	G	G	G	G	G	F, G, J
	39pF (390)	G	G	G	G	G		F, G, J
	47pF (470)	G	G	G	G	G		F, G, J
	56pF (560)	G	G	G	G	G		F, G, J
	68pF (680)	G	G	G	G	G		F, G, J
	82pF (820)	G	G	G	G	G		F, G, J
	100pF (101)	G	G	G	G	G		F, G, J
	120pF (121)	G	G	G	G	G		F, G, J
	150pF (151)	G	G	G	G	G		F, G, J
180pF (181)	G	G	G	G	G		F, G, J	
220pF (221)	G	G	G	G	G		F, G, J	
270pF (271)	G	G	G	G	G		F, G, J	
330pF (331)	G	G	G	G	G		F, G, J	
390pF (391)	G	G	G	G	G		F, G, J	
470pF (471)	G	G	G	G	G		F, G, J	
560pF (561)	G	G	G	G	G		F, G, J	
680pF (681)	G	G	G	G	G		F, G, J	
820pF (821)	G	G	G	G	G		F, G, J	
1000pF (102)	G	G	G	G	G		F, G, J	

1. The letter in cell is expressed the symbol of product thickness.
2. For more information about products with special capacitance or other data, please contact PDC local representative.

8. ELECTRICAL CHARACTERISTICS

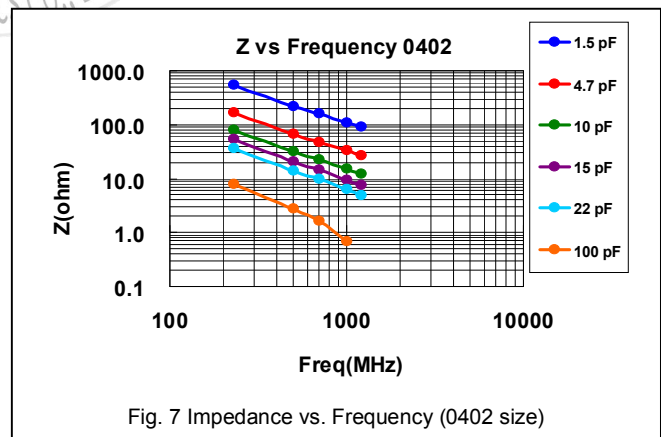
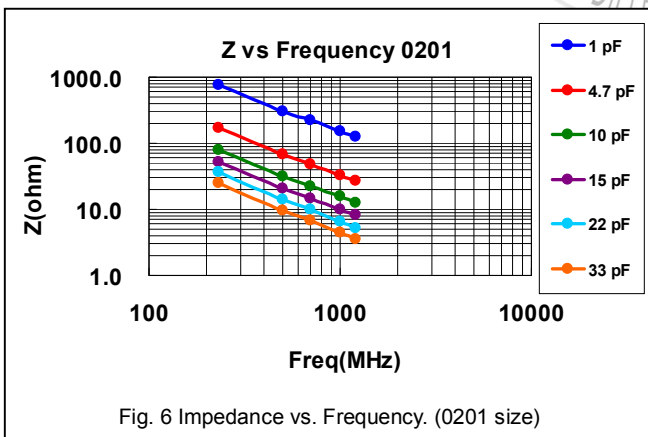
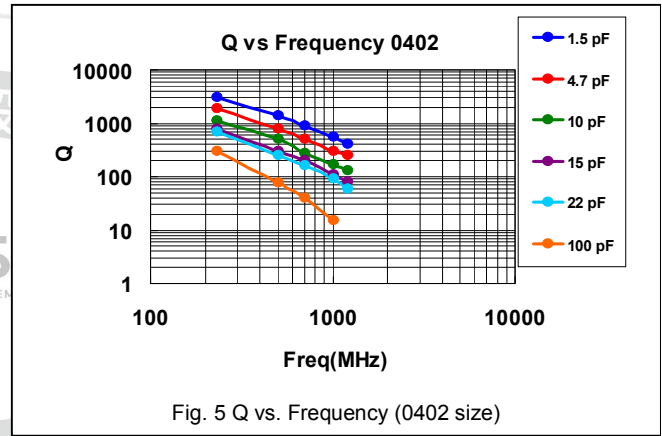
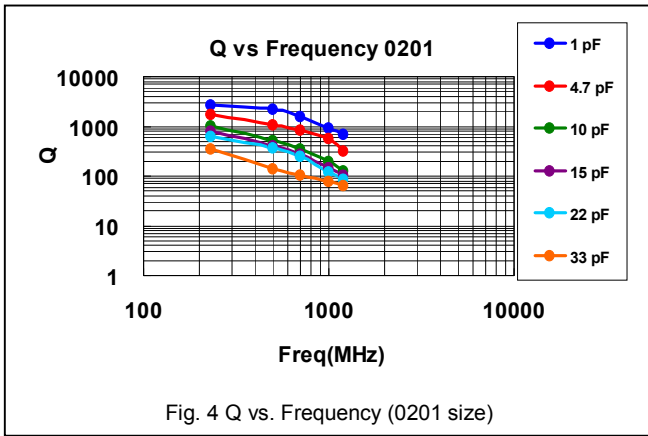
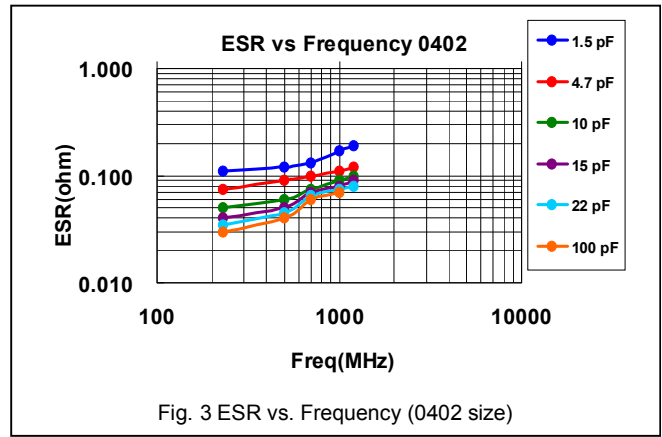
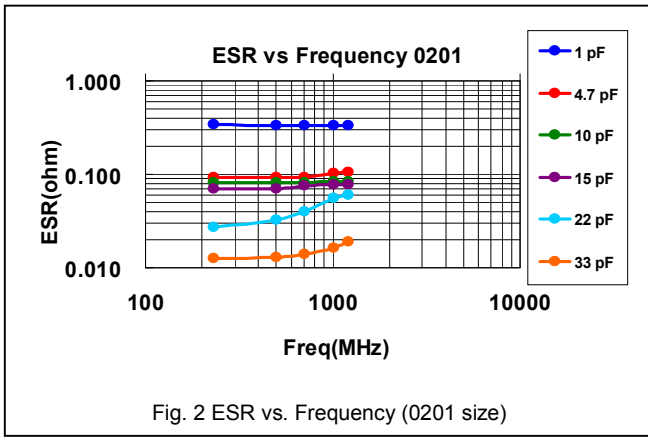

8. ELECTRICAL CHARACTERISTICS

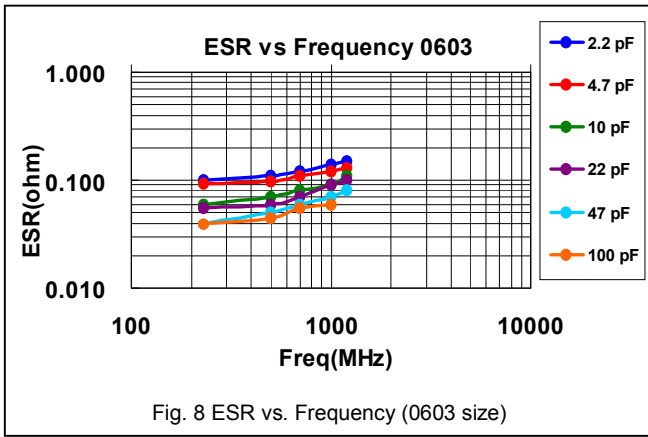

Fig. 8 ESR vs. Frequency (0603 size)

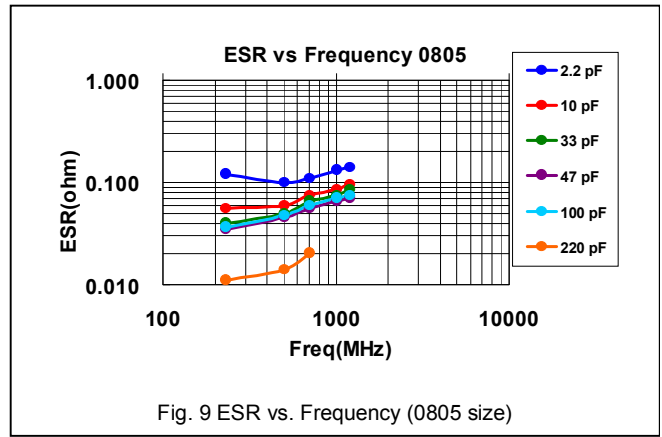

Fig. 9 ESR vs. Frequency (0805 size)

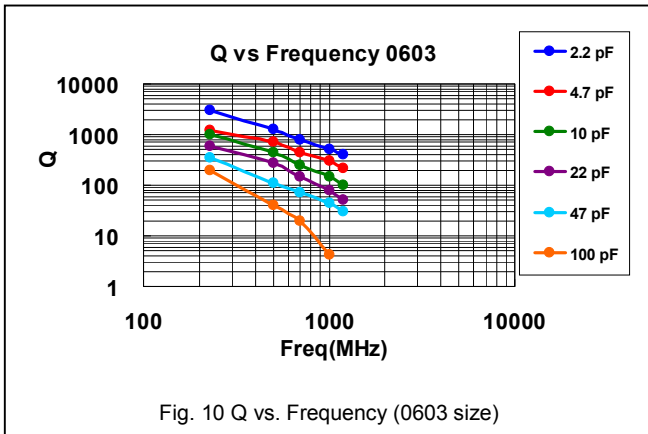

Fig. 10 Q vs. Frequency (0603 size)

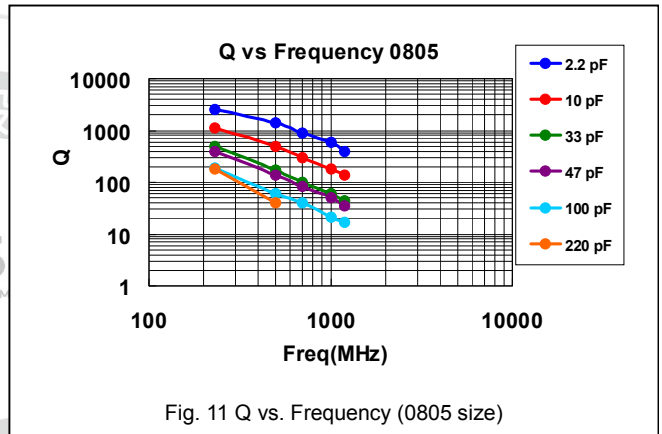

Fig. 11 Q vs. Frequency (0805 size)

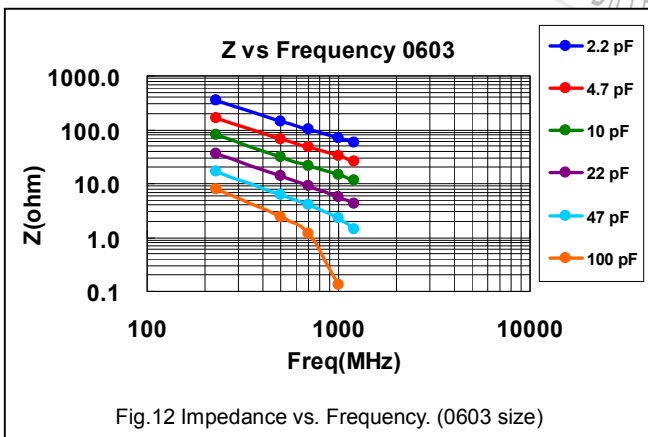

Fig.12 Impedance vs. Frequency. (0603 size)

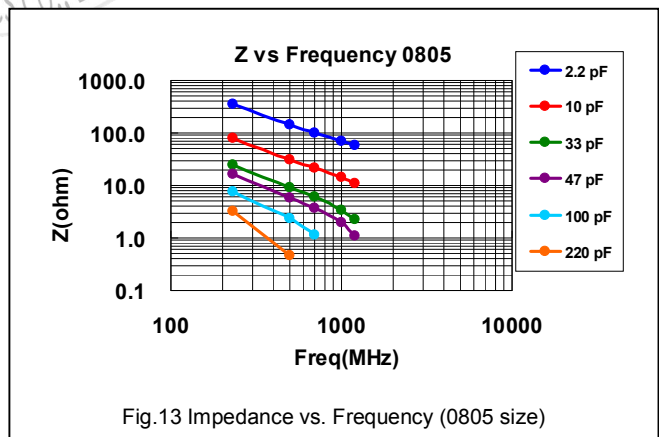

Fig.13 Impedance vs. Frequency (0805 size)

8. ELECTRICAL CHARACTERISTICS

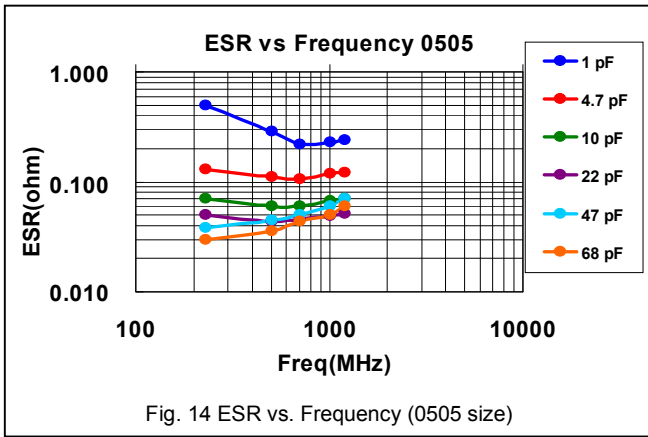

Fig. 14 ESR vs. Frequency (0505 size)

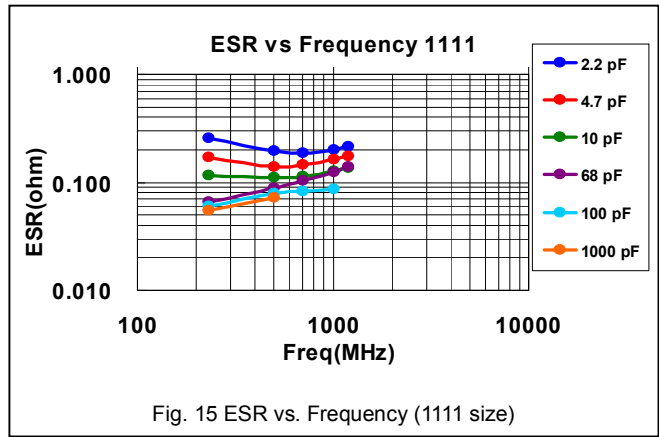

Fig. 15 ESR vs. Frequency (1111 size)

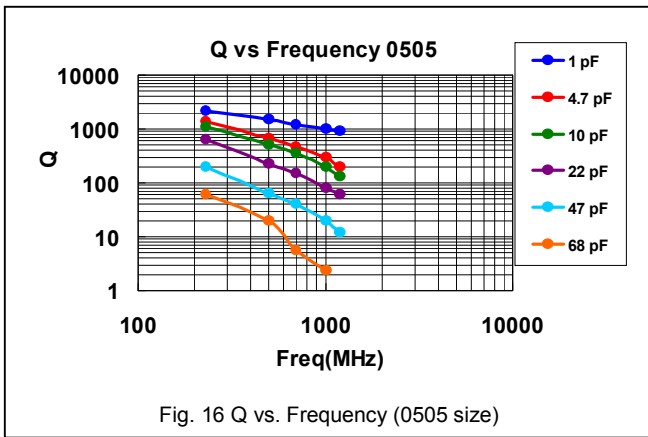

Fig. 16 Q vs. Frequency (0505 size)

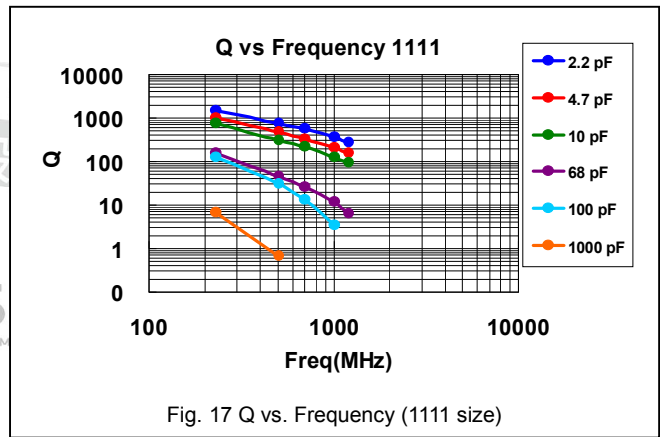

Fig. 17 Q vs. Frequency (1111 size)

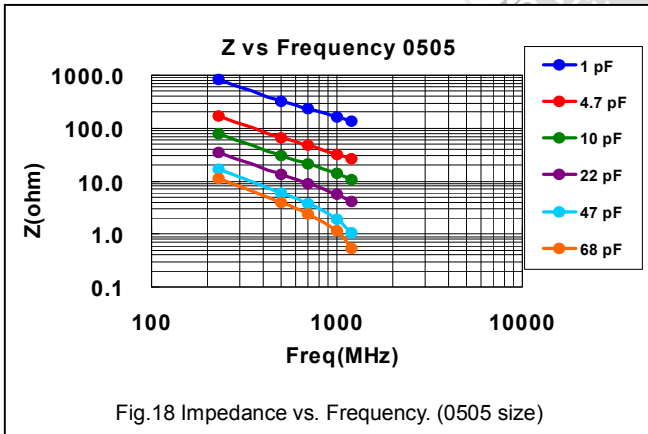

Fig.18 Impedance vs. Frequency. (0505 size)

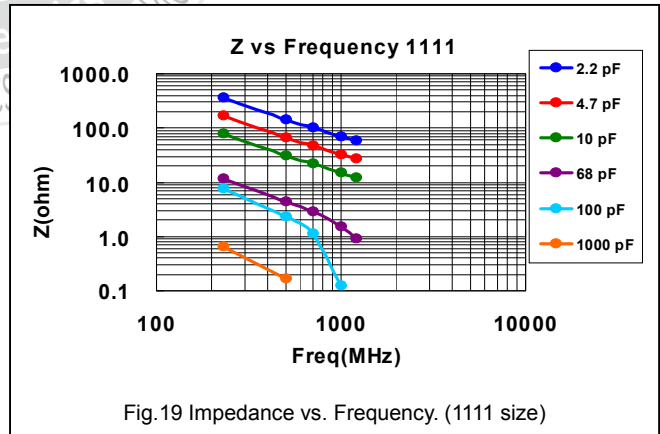

Fig.19 Impedance vs. Frequency. (1111 size)

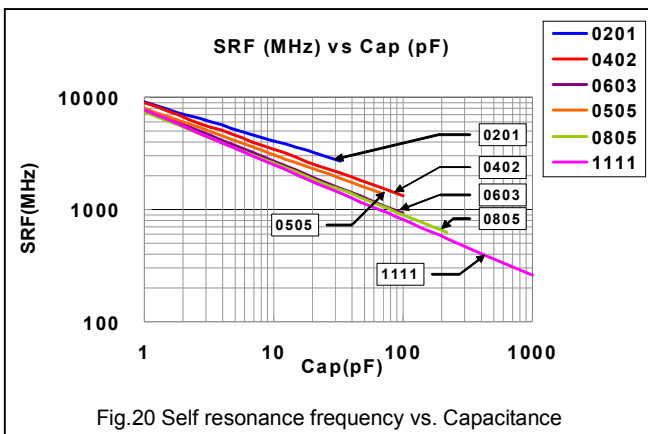

Fig.20 Self resonance frequency vs. Capacitance

9. RELIABILITY TEST CONDITIONS AND REQUIREMENTS

No.	Item	Test Condition	Requirements															
1.	Visual and Dimensions	---	* No remarkable defect. * Dimensions to confirm to individual specification sheet.															
2.	Capacitance		* Shall not exceed the limits given in the detailed spec.															
3.	Q/D.F. (Dissipation Factor)	* Class I : (NP0) Cap.≤1000pF, 1.0±0.2Vrms, 1MHz±10%. Cap.>1000pF, 1.0±0.2Vrms, 1KHz±10%. At 25°C ambient temperature.	* 01005, 0201, 0402/25V~50V : Cap.<30pF, Q≥400+20C; Cap.≥30pF, Q≥1000 * 0402/100V~200V, 0603, 0805, 0505, 1111 : Cap.<30pF : Q≥800+20C; Cap.≥30pF : Q≥1400															
4.	Temperature Coefficient	* With no electrical load. <table border="1"> <thead> <tr> <th>T.C.</th> <th>Operating Temp.</th> </tr> </thead> <tbody> <tr> <td>NP0</td> <td>-55~125°C at 25°C</td> </tr> </tbody> </table>	T.C.	Operating Temp.	NP0	-55~125°C at 25°C	<table border="1"> <thead> <tr> <th>T.C.</th> <th>Capacitance Change</th> </tr> </thead> <tbody> <tr> <td>NP0</td> <td>Within ±30ppm/°C</td> </tr> </tbody> </table>	T.C.	Capacitance Change	NP0	Within ±30ppm/°C							
T.C.	Operating Temp.																	
NP0	-55~125°C at 25°C																	
T.C.	Capacitance Change																	
NP0	Within ±30ppm/°C																	
5.	Insulation Resistance	* ≤100V : To apply rated voltage for max. 120 sec. * ≥200V :To apply rated voltage (500V max.) for 60 sec.	* ≥10GΩ or RxC≥100Ω-F, whichever is smaller.															
6.	Dielectric Strength	* To apply voltage : ≤100V : 250% of rated voltage. 200V ~ 300V : 200% of rated voltage. 500V ~ 999V : 150% of rated voltage. 1000V ~ 3000V : 120% of rated voltage. 4000V : 110% of rated voltage. * Duration : 1 to 5 sec. * Charge & discharge current less than 50mA.	* No evidence of damage or flash over during test.															
7.	Solderability	* Solder temperature : 235±5°C. * Dipping time : 2±0.5 sec.	* 95% min. coverage of all metalized area.															
8.	Resistance to Soldering Heat	* Solder temperature : 260±5°C. * Dipping time : 10±1 sec. * Preheating : 120 to 150°C for 1 minute before immerse the capacitor in a eutectic solder. * Cap. / DF(Q) / I.R. Measurement to be made after de-aging at 150°C for 1hr then set for 24±2 hrs at room temp.	* No remarkable damage. * Cap. change : Within ±2.5% or ±0.25pF whichever is larger. * Q/D.F., I.R. and dielectric strength : To meet initial requirements. * 25% max. leaching on each edge.															
9.	Temperature Cycle	* Conduct the five cycles according to the temperatures and time. <table border="1"> <thead> <tr> <th>Step</th> <th>Temp.(°C)</th> <th>Time(min.)</th> </tr> </thead> <tbody> <tr> <td>1</td> <td>Min. operating temp. +0/-3</td> <td>30±3</td> </tr> <tr> <td>2</td> <td>Room temp.</td> <td>2~3</td> </tr> <tr> <td>3</td> <td>Max. operating temp. +3/-0</td> <td>30±3</td> </tr> <tr> <td>4</td> <td>Room temp.</td> <td>2~3</td> </tr> </tbody> </table> * Cap. / DF(Q) / I.R. Measurement to be made after de-aging at 150°C for 1hr then set for 24±2 hrs at room temp.	Step	Temp.(°C)	Time(min.)	1	Min. operating temp. +0/-3	30±3	2	Room temp.	2~3	3	Max. operating temp. +3/-0	30±3	4	Room temp.	2~3	* No remarkable damage. * Cap. change : Within ±2.5% or ±0.25pF, whichever is larger. * Q/D.F., I.R. and dielectric strength : To meet initial requirements.
Step	Temp.(°C)	Time(min.)																
1	Min. operating temp. +0/-3	30±3																
2	Room temp.	2~3																
3	Max. operating temp. +3/-0	30±3																
4	Room temp.	2~3																
10.	Humidity (Damp Heat) Steady State	* Test temp. : 40±2°C. * Humidity : 90~95% RH. * Test time : 500 +24/-0hrs. * Cap./DF(Q) Measurement to be made after de-aging at 150°C for 1hr then set for 24±2 hrs at room temp.	* No remarkable damage. * Cap. change : Within ±5.0% or ±0.5pF, whichever is larger. * Q/D.F. value : Cap.>30pF, Q≥350. 10pF≤Cap.≤30pF, Q≥275+2.5C. Cap.<10pF, Q≥200+10C. * I.R. : ≥1GΩ.															

9. RELIABILITY TEST CONDITIONS AND REQUIREMENTS

No.	Item	Test Condition	Requirements																																																								
11.	Humidity (Damp Heat) Load	* Test temp. : 40±2°C. * Humidity : 90~95%RH. * Test time : 500 +24/-0hrs. * To apply voltage : Rated voltage (500Vdc max.). * Cap./DF(Q) Measurement to be made after de-aging at 150°C for 1hr then set for 24±2 hrs at room temp.	* No remarkable damage. * Cap. change : Within ±7.5% or ±0.75pF, whichever is larger. * Q/D.F. value : Cap.≥30pF, Q≥200; Cap.<30pF, Q≥100+10/3C. * I.R. : ≥500MΩ.																																																								
12.	High Temperature Load (Endurance)	* Test temp. : 125±3°C. * To apply voltage : (1) 10V≤Ur<500V : 200% of rated voltage. (2) ≤6.3V or 500V : 150% of rated voltage. (3) Ur≥630V : 120% of rated voltage. * Test time : 1000 +24/-0 hrs. * Cap. / DF(Q) / I.R. Measurement to be made after de-aging at 150°C for 1hr then set for 24±2 hrs at room temp.	* No remarkable damage. * Cap. change : Within ±3.0% or ±0.3pF, whichever is larger. * Q/D.F. value : Cap.>30pF, Q≥350. 10pF≤Cap.≤30pF, Q≥275+2.5C. Cap.<10pF, Q≥200+10C. * I.R. : ≥1GΩ.																																																								
13.	Adhesive Strength of Termination	* Pressurizing force : 01005 : 1N / 0201 : 2N. 0402 to 0603 : 5N / >0603 : 10N. * Test time : 10±1 sec.	* No remarkable damage or removal of the terminations.																																																								
14.	Bending Test	* The middle part of substrate shall be pressurized by means of the pressurizing rod at a rate of about 1 mm per second until the deflection becomes 1 mm and then the pressure shall be maintained for 5±1 sec. * Measurement to be made after keeping at room temp. for 24±2 hrs.	* No remarkable damage. <table border="1" style="width: 100%;"> <thead> <tr> <th>Dielectric</th> <th>Cap. Change</th> </tr> </thead> <tbody> <tr> <td>Class I (NPO)</td> <td>Within ±5.0% or ±0.5pF, whichever is larger</td> </tr> </tbody> </table> (This capacitance change means the change of capacitance under specified flexure of substrate from the capacitance measured before the test)	Dielectric	Cap. Change	Class I (NPO)	Within ±5.0% or ±0.5pF, whichever is larger																																																				
Dielectric	Cap. Change																																																										
Class I (NPO)	Within ±5.0% or ±0.5pF, whichever is larger																																																										
15.	Vibration Resistance	* Vibration frequency : 10~55 Hz/min. * Total amplitude : 1.5mm. * Test time : 6 hrs. (Two hrs each in three mutually perpendicular directions) * Cap./DF(Q) Measurement to be made after de-aging at 150°C for 1hr then set for 24±2 hrs at room temp.	* No remarkable damage. * Cap. change and D.F. : To meet initial spec.																																																								
16.	ESR	* The ESR should be measured at room temperature and tested at frequency 1±0.1 GHz. * The ESR should be measured at room temperature and tested at frequency 500±50 MHz.	<table border="1" style="width: 100%;"> <thead> <tr> <th colspan="2">01005</th> <th colspan="2">0505</th> </tr> </thead> <tbody> <tr> <td>0.2pF≤Cap.≤1pF</td> <td><700mΩ/pF</td> <td>0.4pF≤Cap.<1.0pF</td> <td><1500mΩ</td> </tr> <tr> <td>1pF<Cap.≤2pF</td> <td><600mΩ</td> <td>1.0pF≤Cap.<10pF</td> <td><250mΩ</td> </tr> <tr> <td>2pF<Cap.≤5pF</td> <td><500mΩ</td> <td>10pF≤Cap.≤100pF</td> <td><200mΩ</td> </tr> <tr> <td>5pF<Cap.≤10pF</td> <td><300mΩ</td> <td></td> <td></td> </tr> <tr> <td>10pF<Cap.≤22pF</td> <td><350mΩ</td> <td></td> <td></td> </tr> </tbody> </table> <table border="1" style="width: 100%;"> <thead> <tr> <th colspan="2">0201</th> <th colspan="2">0402</th> </tr> </thead> <tbody> <tr> <td>0.1pF≤Cap.≤1pF</td> <td><350mΩ/pF</td> <td>0.1pF≤Cap.≤1pF</td> <td><350mΩ/pF</td> </tr> <tr> <td>1pF<Cap.≤5pF</td> <td><300mΩ</td> <td>1pF<Cap.≤5pF</td> <td><300mΩ</td> </tr> <tr> <td>5pF<Cap.≤22pF</td> <td><250mΩ</td> <td>5pF<Cap.≤100pF</td> <td><250mΩ</td> </tr> </tbody> </table> <table border="1" style="width: 100%;"> <thead> <tr> <th colspan="2">0603</th> <th colspan="2">0805</th> </tr> </thead> <tbody> <tr> <td>0.3pF≤Cap.≤1pF</td> <td><1500mΩ</td> <td>0.3pF≤Cap.≤1pF</td> <td><1500mΩ</td> </tr> <tr> <td>1pF<Cap.≤10pF</td> <td><250mΩ</td> <td>1pF<Cap.≤10pF</td> <td><250mΩ</td> </tr> <tr> <td>10pF<Cap.≤220pF</td> <td><200mΩ</td> <td>Cap.>10pF</td> <td><200mΩ</td> </tr> </tbody> </table> * 0201, 22pF≤Cap.≤33pF : < 300mΩ.	01005		0505		0.2pF≤Cap.≤1pF	<700mΩ/pF	0.4pF≤Cap.<1.0pF	<1500mΩ	1pF<Cap.≤2pF	<600mΩ	1.0pF≤Cap.<10pF	<250mΩ	2pF<Cap.≤5pF	<500mΩ	10pF≤Cap.≤100pF	<200mΩ	5pF<Cap.≤10pF	<300mΩ			10pF<Cap.≤22pF	<350mΩ			0201		0402		0.1pF≤Cap.≤1pF	<350mΩ/pF	0.1pF≤Cap.≤1pF	<350mΩ/pF	1pF<Cap.≤5pF	<300mΩ	1pF<Cap.≤5pF	<300mΩ	5pF<Cap.≤22pF	<250mΩ	5pF<Cap.≤100pF	<250mΩ	0603		0805		0.3pF≤Cap.≤1pF	<1500mΩ	0.3pF≤Cap.≤1pF	<1500mΩ	1pF<Cap.≤10pF	<250mΩ	1pF<Cap.≤10pF	<250mΩ	10pF<Cap.≤220pF	<200mΩ	Cap.>10pF	<200mΩ
01005		0505																																																									
0.2pF≤Cap.≤1pF	<700mΩ/pF	0.4pF≤Cap.<1.0pF	<1500mΩ																																																								
1pF<Cap.≤2pF	<600mΩ	1.0pF≤Cap.<10pF	<250mΩ																																																								
2pF<Cap.≤5pF	<500mΩ	10pF≤Cap.≤100pF	<200mΩ																																																								
5pF<Cap.≤10pF	<300mΩ																																																										
10pF<Cap.≤22pF	<350mΩ																																																										
0201		0402																																																									
0.1pF≤Cap.≤1pF	<350mΩ/pF	0.1pF≤Cap.≤1pF	<350mΩ/pF																																																								
1pF<Cap.≤5pF	<300mΩ	1pF<Cap.≤5pF	<300mΩ																																																								
5pF<Cap.≤22pF	<250mΩ	5pF<Cap.≤100pF	<250mΩ																																																								
0603		0805																																																									
0.3pF≤Cap.≤1pF	<1500mΩ	0.3pF≤Cap.≤1pF	<1500mΩ																																																								
1pF<Cap.≤10pF	<250mΩ	1pF<Cap.≤10pF	<250mΩ																																																								
10pF<Cap.≤220pF	<200mΩ	Cap.>10pF	<200mΩ																																																								

10. PACKAGE DIMENSION AND QUANTITY

Paper Tape :

Size	Thickness (mm)/Symbol		Paper tape	
			7" reel	13" reel
01005 (0402)	0.20±0.02	V	20,000	-
0201 (0603)	0.30±0.03	L	15,000	70,000
0402 (1005)	0.50±0.05	N	10,000	50,000
0603 (1608)	0.80±0.07	S	4,000	15,000
	0.50±0.10	H	4,000	-
0805 (2012)	0.60±0.10	A	4,000	15,000
	0.85±0.10	T	4,000	15,000

Plastic Tape :

Size	Thickness (mm)/Symbol		Plastic tape	
			7" reel	13" reel
0505 (1414)	1.15±0.15	J	3,000	-
1111 (2828)	≤ 1.78	G	2,000	-

Tape & reel dimensions :

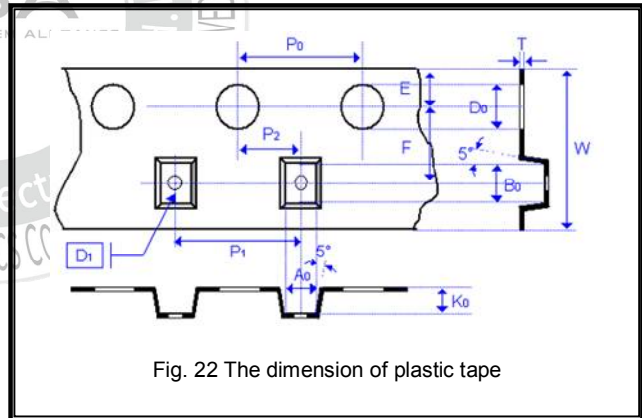
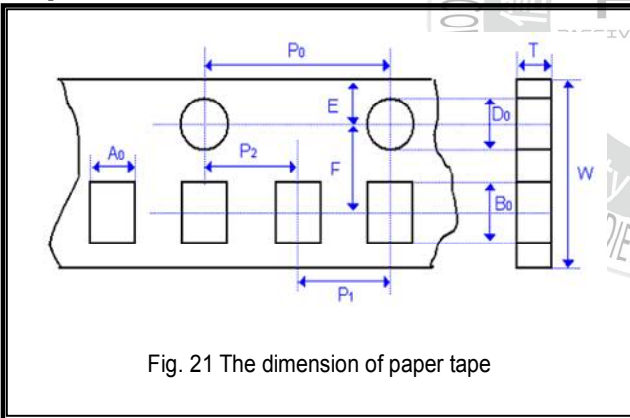

Size	01005	0201	0402	0505	0603	0805	1111
Thickness	V	L	N	J	S	T	G
A ₀	0.25±0.05	0.40±0.10	0.70±0.20	<1.90	1.05±0.30	1.50±0.20	<3.05
B ₀	0.45±0.05	0.70±0.10	1.20±0.20	<1.90	1.80±0.30	2.30±0.20	<3.80
T	≤0.50	≤0.55	≤0.80	0.23±0.10	≤1.20	≤1.20	0.23±0.10
K ₀	-	-	-	<1.50	-	-	< 2.50
W	8.00±0.30	8.00±0.30	8.00±0.30	8.00±0.30	8.00±0.30	8.00±0.30	8.00±0.30
P ₀	4.00±0.10	4.00±0.10	4.00±0.10	4.00±0.10	4.00±0.10	4.00±0.10	4.00±0.10
10xP ₀	40.00±0.10	40.00±0.10	40.00±0.10	40.00±0.20	40.00±0.20	40.00±0.20	40.00±0.20
P ₁	2.00±0.05	2.00±0.05	2.00±0.05	4.00±0.10	4.00±0.10	4.00±0.10	4.00±0.10
P ₂	2.00±0.05	2.00±0.05	2.00±0.05	2.00±0.05	2.00±0.05	2.00±0.05	2.00±0.05
D ₀	1.50±0.1/-0	1.50±0.1/-0	1.50±0.1/-0	1.50±0.1/-0	1.50±0.1/-0	1.50±0.1/-0	1.50±0.1/-0
D ₁	-	-	-	1.00±0.10	-	-	1.00±0.10
E	1.75±0.10	1.75±0.10	1.75±0.10	1.75±0.10	1.75±0.10	1.75±0.10	1.75±0.10
F	3.50±0.05	3.50±0.05	3.50±0.05	3.50±0.05	3.50±0.05	3.50±0.05	3.50±0.05

10. PACKAGE DIMENSION AND QUANTITY

Paper Tape :

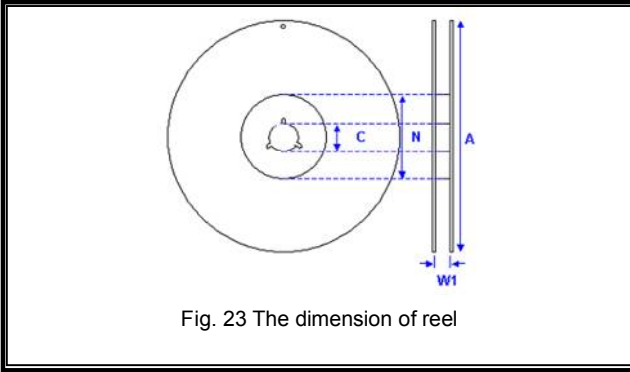

Size	01005, 0201, 0402, 0505, 0603, 0805, 1111	
Reel size	7"	13"
C	13.0 +0.5/-0.2	13.0 +0.5/-0.2
W ₁	8.4 +1.5/-0	8.4 +1.5/-0
A	178.0±1.0	330.0±1.0
N	60.0 +1.0/-0	100.0±1.0

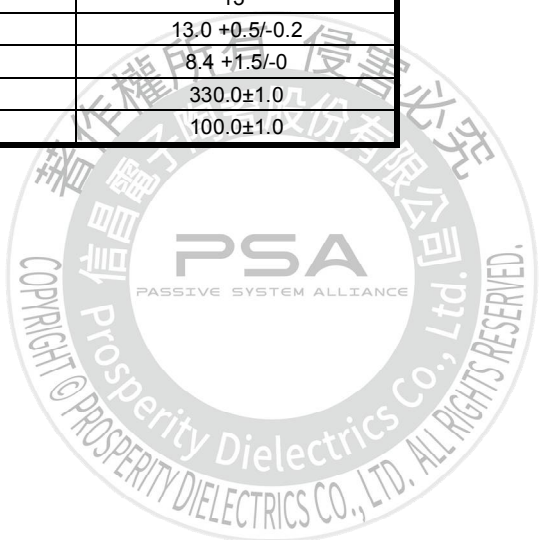

11. APPENDIXES

Constructions :

No.	Name	NP0	
①	Ceramic material	BaTiO ₃ based	
②	Inner electrode	Cu	
③	Termination	Inner layer	Cu
④		Middle layer	Ni
⑤		Outer layer	Sn (Matt)

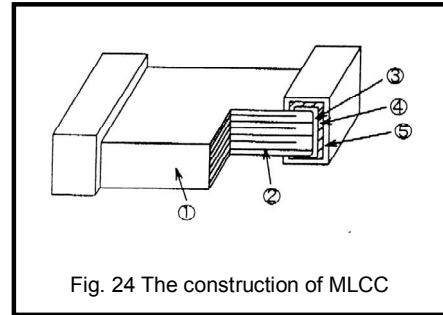

Fig. 24 The construction of MLCC

Storage and handling conditions

- (1) To store products at 5 to 40°C ambient temperature and 20 to 70% related humidity conditions.
- (2) The product is recommended to be used within one year after shipment. Check solderability in case of shelf life extension is needed.

Cautions:

- a. The corrosive gas reacts on the terminal electrodes of capacitors, and results in the poor solderability. Do not store the capacitors in the ambience of corrosive gas (e.g., hydrogen sulfide, sulfur dioxide, chlorine, ammonia gas etc.)
- b. In corrosive atmosphere, solderability might be degraded, and silver migration might occur to cause low reliability.
- c. Due to the dewing by rapid humidity change, or the photochemical change of the terminal electrode by direct sunlight, the solderability and electrical performance may deteriorate. Do not store capacitors under direct sunlight or dewing condition. To store products on the shelf and avoid exposure to moisture.

Recommended soldering conditions

The lead-free termination MLCCs are not only to be used on SMT against lead-free solder paste, but also suitable against lead-containing solder paste. If the optimized solder joint is requested, increasing soldering time, temperature and concentration of N₂ within oven are recommended.

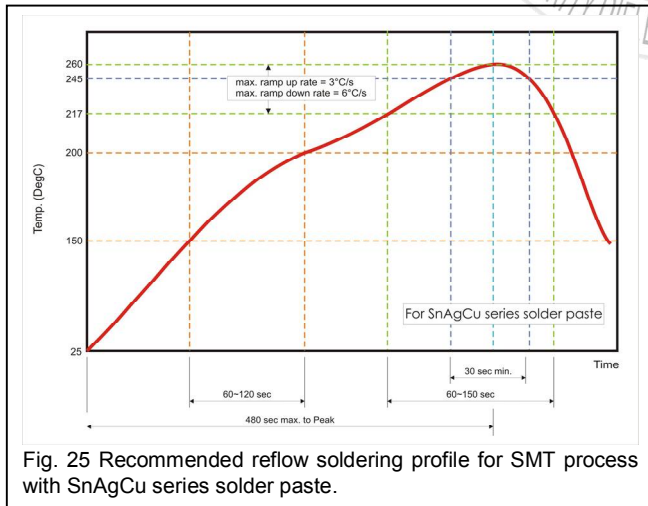

Fig. 25 Recommended reflow soldering profile for SMT process with SnAgCu series solder paste.

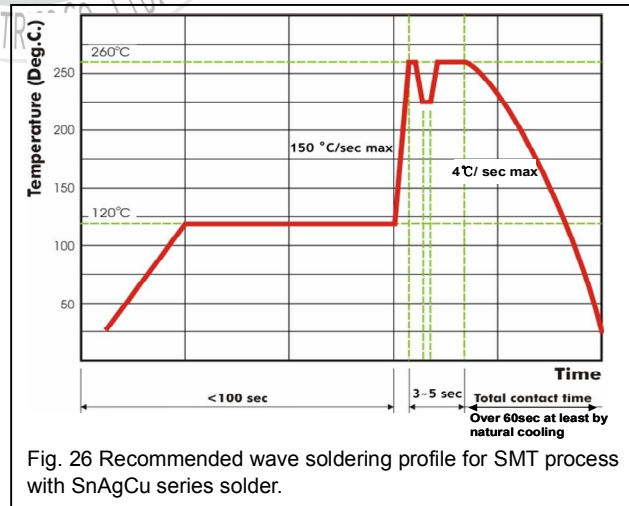

Fig. 26 Recommended wave soldering profile for SMT process with SnAgCu series solder.