



智新电子(厦门)有限公司

JIMSON ELECTRONICS (XIAMEN) CO.,LTD.

File NO (文件编号):	JS-S20210906210
-----------------	-----------------

规格书

SPECIFICATION

☆客户名称

CUSTOMER: 立创

☆产品名称

PROD NAME: 电容器/Capacitor

☆类别

TYPE: MPC

☆规格

DESCRIPTION: 0.68~12.0uF K 500~1200VDC

☆日期

DATE: 2021-09-06

编 制: 徐玉倩

审 核: 梁亚苗

会 签:
日 期:

注意事项:

- 1、本规格书双方签字后正式生效，本规格书共 8 页；
- 2、本规格书一式两份，任何对内容的改动必须经双方同意，并以书面文件的形式发布。

1.SPECIFIC REFERENCE DATA

DESCRIPTION		VALUE	TEST CONDITIONS
Capacitance 容量	Rated Capacitance 标称值	0.68~12.0uF	Measuring frequency: 1kHz Measuring voltage: 1V
	Capacitance olerance 容量误差	K=±10%	
Voltage 电压	Rated voltage 额定电压	500~900VDC	1.6*UR Unit:VDC (1 minute at 20°C)
	Voltage proof 耐电压	无永久性击穿及飞弧	
Dissipation factor (tangent of loss) 散逸因素(损耗角正切)		DF≤0.1% (at 20°C,1KHz)	Measuring frequency: 1kHz Measuring voltage: 1V
Insulation resistance 绝缘电阻		C≤0.33uF IR≥30000MΩ C >0.33uF IR*C≥5000S	measured at rated voltage or less than 100VDC 1 minute at 20°C and RH≤65%
Endurance 耐久性		Δ C/C≤5%; Δ DF≤0.40%; IR≥50% of the specified value	1000 hours with 125% of rated voltage at 85°C. After the test
Climatic catalogue 气候类别		40/85/21	
Solder ability 可焊性		Solder should cover at least 75% of the circumference of the lead 浸没部分引脚需有 75%以上面积挂上锡	solder bath : 235±5°C bath time: 2.0±0.5 sec speed: 25±6 mm/sec depth: 1.5+0.5/-0mm from the bottom of the body
Heat shock 耐焊接热		Δ C/C≤±5%, DF≤1.2*规定值。 试验后电容器外观应无可见损伤,	solder bath : 260±5°C bath time: 5.0±0.5 sec speed: 25±6 mm/sec depth: 1.5+0.5/-0mm from the bottom of the body
Lead tensile strength: 引脚拉伸强度		外观无损伤	Pull: 2.2 LBS time: 5 sec
Lead bending strength 引脚弯曲强度		引脚无损伤	Load of lead: 1.1 LBS The body of capacitor is bent 90 degrees and returned to its original position
Vibration 震动		外观无可见损伤	Frequency cycle: from 10Hz to 55Hz and then 10Hz Amplitude: 1.5mm in three directions Time: 2 hours each directions with a total of 6 hours
Reference standard 引用标准		IEC 384-16,GB10190	

2.CONSTRUCTION:

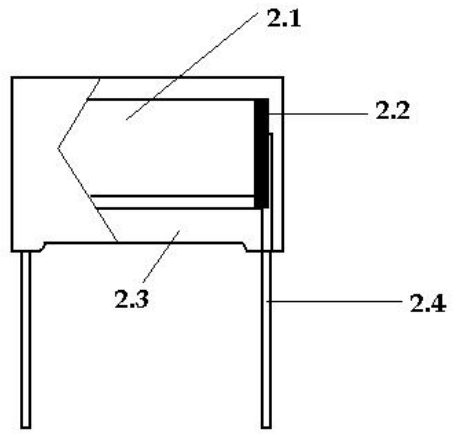
2.1 Dielectric 介质	polypropylene film 聚丙烯薄膜	
2.2 Electrodes 电极	vacuum evaporated metal 真空蒸镀金属	
2.3 coating 包封	Encapsulated in reinforced flame retardant plastic case sealed with epoxy resin meeting the requirement of-UL94V-0 (阻燃盒子并以环氧树脂灌封)	
2.4 LEADS 导线	Radial leads of tinned wire/insulation flexible wire 径向镀锡导线或软导线	
2.5 Terminal contact 引线连接方式	electrically welded; 电弧点焊	

3.FEATURE:

- 无感型型结构，自愈性好
Non-inductive construction and self-healing
- 高耐湿特性
High property moisture resistance
- 优异的物理特性及环境适应性
Super physical and environmental characteristics.

4.APPLICATION:

- 应用于电力电子设备中的串并联谐振电路；
Widely used in power electronic devices in series/parallel resonant circuit;
- 应用于电力电子设备中开关器件关断时的尖峰电压，尖峰电流吸收保护；
Widely used in power electronic equipment when the peak voltage ,peak current
Absorption protection;
- 高性能直流滤波应用场合。
High performance DC filtering applications.

5.MARKING: (打印方式: UV 油墨或激光雕刻)**5.1 电容印刷内容 Marking on individual capacitor includes:**

- 额定容量 Rated capacitance: such as 0.68~12.0uF
- 额定电压 Rated voltage: such as 500~1200VDC
- 容量偏差 Capacitance tolerance: such as K.
- 制造商 Manufacturer's symbol: JIMSON (JS).

5.2 包装标签 Marking on package

包装标签上包含产品型号、额定容量和电压、生产日期和厂址。

Each package unit carry the type, rating, quantity and date of manufacture,
location of manufacture, and manufacturer's name

6.EXPLANATION OF IMPORTANT TERMINOLOGY:

6.1 容量 Rated capacitance

产品的电容量用三位数字来表示，其中前两位数代表电容量的标称值，后一位表示电容量的指数值，即标称值后零的个数。单位为 PF

The rated capacitance value in Pico farads is expressed by a three digit number, the first two digits are significant figures and the last digit specifies the number of zero to follow.

Example: 224 indicated 220,000pF or 0.22uF

225 indicated 2,200,000pF or 2.2Uf

容量单位 CAPACITANCE UNIT:

1F=1,000mF=1,000,000uF=1,000,000,000nF=1,000,000,000,000Pf

6.2 容量误差 Capacitance tolerance

容量误差为实际容量与标称容量的偏差百分比。

The tolerance is the permissible actual capacitance relative to the rated capacitance and it is defined in percent.

Symbol of tolerance shown:

F=±1%	G=±2%	J=±5%	K=±10%	M=±20%	N=±30%
-------	-------	-------	--------	--------	--------

6.3 散逸因素 Dissipation factor

散逸因素是电容器在交变电压下功率损耗的衡量尺寸，它由有功损耗和无功损耗的比值确定。散逸因素随着温度、频率的不同而改变。通常以 20℃、1kHz 作为标准条件进行测量。

Dissipation factor is a measure of the power loss in a capacitor in the case of sinusoidal voltage. It's defined as the ratio between the active power P and the reactive power Q: $\tan \delta = P/Q$. As it verify with temperature and frequency it is measured at 20℃ and 1kHz as the standard of measure condition.

6.4 绝缘电阻 Insulation resistance

绝缘电阻是衡量电容器绝缘特性的指标，为电容器充电一分钟后所加的直流电压和流经电容器的漏电流值的比值，测试条件为：T=20℃，RH≤65%

一般情况下，小容量电容器的绝缘特性直接用绝缘电阻表示，单位为兆欧；大容量电容器的绝缘特性常用时间常数描述。

Insulation resistance is a measure of the capacitors ability to retain an electrical charge for an extended period of time. It is the ratio between an applied direct voltage and the current, which flows through the capacitor. The current is measured 60s after the voltage has been applied. Ambient temperature. T=20℃ and RH≤65%. The insulation resistance is normally expressed in megohm for low capacitance capacitors and as a time constant stated in megohm-microfarads (The product of the IR measured is megohm and the capacitance measured in microfarad) for the higher capacitance value capacitor.

6.5 自愈性 Self-healing

铝箔电容器被击穿时，由于介质中碳元素温度升高会形成永久性的通路。

金属化薄膜电容器由于有自愈能力，能在被击穿时不会形成永久性的通路。当

介质上存在缺陷, 该处就可能发生局部电击穿。当电击穿处周围金属镀层由于电弧放电而蒸发, 击穿点与周围极板隔开, 电容器即可自愈。

A break-through in a plastic film/foil capacitor leads to a permanent short circuit of the capacitor due to the carbon bridge, which is built up in the break-down channel due to the high temperature rise and carbon content of the dielectric.

A metallized capacitor can withstand a break-through without a permanent short circuit on account of its self-healing ability. At a weak point in the dielectric, or because of a transient, a break-down may occur. The thin metal layer around the weak point is evaporated and the weak point is isolated. The capacitor has self-healed.

7. WEATHERABILITY TESTING METHODS:

7.1 上限温度 High temperature

将电容器放置于恒温烤箱, 并将温度设定在 85℃。温度稳定后, 电容器的测量结果需符合以下两项:

7.1.1 容量变化: 最大不超过初始值的+5%

7.1.2 DF 值变化: 小于 0.2% (使用 1KHz 检测)

Place the capacitor in a thermostatic oven kept at +85 °C after reaching the thermal stability, The result of measurement shall meet the requirement given in the following items:

7.1.1 Capacitance drift: the rate +5% max of initial value;

7.1.2 Dissipation factor: less than 0.2% at 1KHz

7.2 下限温度 Low temperature

将电容器放置于恒温烤箱, 并将温度设定在-40℃。温度稳定后, 电容器的测量结果需符合以下两项:

7.2.1 容量变化: 最大不超过初始值的-5%

7.2.2 DF 值变化: 小于 0.15% (使用 1KHz 检测)

Place the capacitor in a thermostatic oven kept at -40 °C after reaching the thermal stability, The result of measurement shall meet the requirement given in the following items:

7.2.1 Capacitance drift: the rate -5% max of initial value;

7.2.2 Dissipation factor: less than 0.15% at 1KHz;

7.3 稳态湿热 Humidity

将电容器放置于恒温烤箱内 1000±4%小时, 保持温度为 85±3℃, 湿度 85±3%, 然后将电容器取出放置 16 小时, 测试结果需符合以下三项:

7.3.1 容量偏离: 最大不超过初始值的+10%

7.3.2 DF 值: 最大不超过 0.2% (使用 1KHz 检测)

7.3.3 绝缘电阻: 大于初始值的 50%

Place the capacitor in a thermostatic oven kept at temperature 85 ± 3 °C and humidity 85 ± 3% for 1000 ± 1% hs. After this, take out the capacitor from the thermostatic oven for 16 hours. The result of measurement shall meet the requirement given in the following items:

7.3.1 capacitance drift: +10% max of initial value.

7.3.2 Insulation resistance: over than 50% of initial value.

7.3.3 Dissipation factor: less than 0.2%.

8. PROPERTIES OF CAPACITOR AND THE DIELECTRICS:

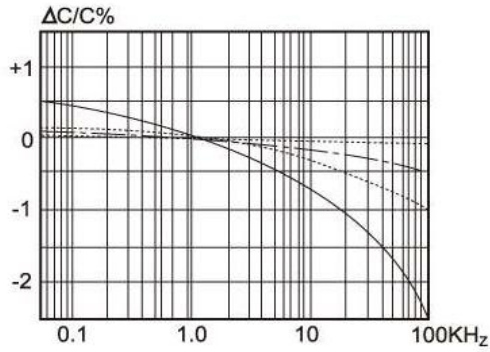

Capacitance vs. Frequency
容量与频率

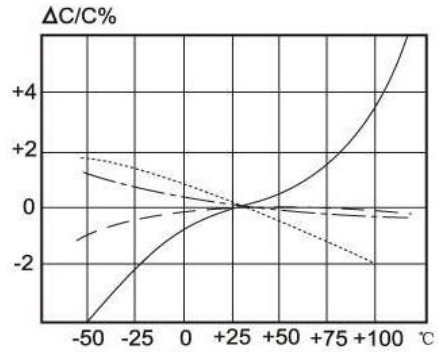

Capacitance vs. Temperature
容量与温度

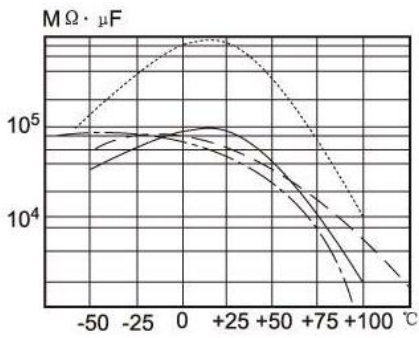

Insulation resistance vs. Temperature
绝缘电阻与温度

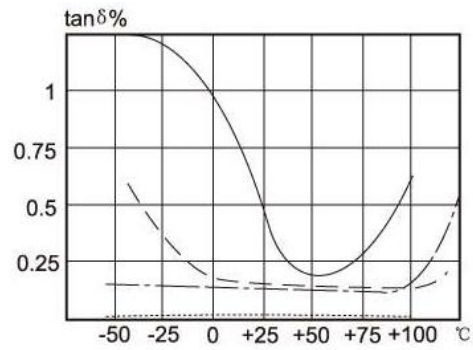

Dissipation factor vs. Temperature
损耗与温度

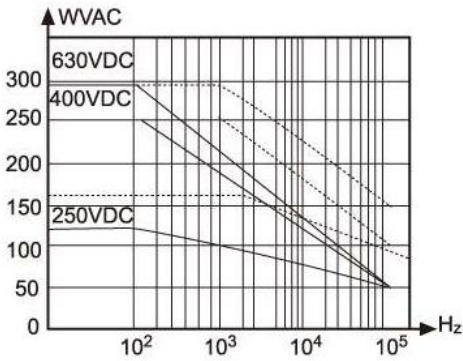

Working Voltage DC&AC vs. Frequency
工作电压直流交流与频率

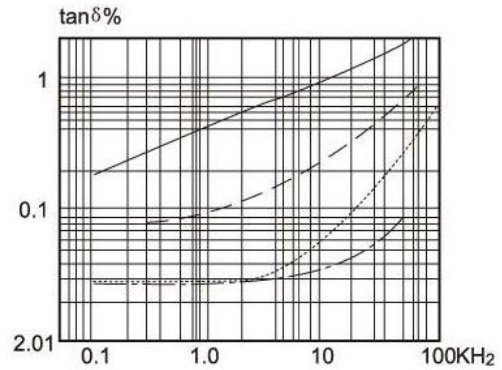

Dissipation factor vs. Frequency
损耗与频率

—————	聚酯	Polyester
.....	聚丙烯	Polypropylene
—————	聚碳酸酯	Polycarbonate
—————	聚苯乙烯	Polystyrene

9.OUTLINE DRAWING:

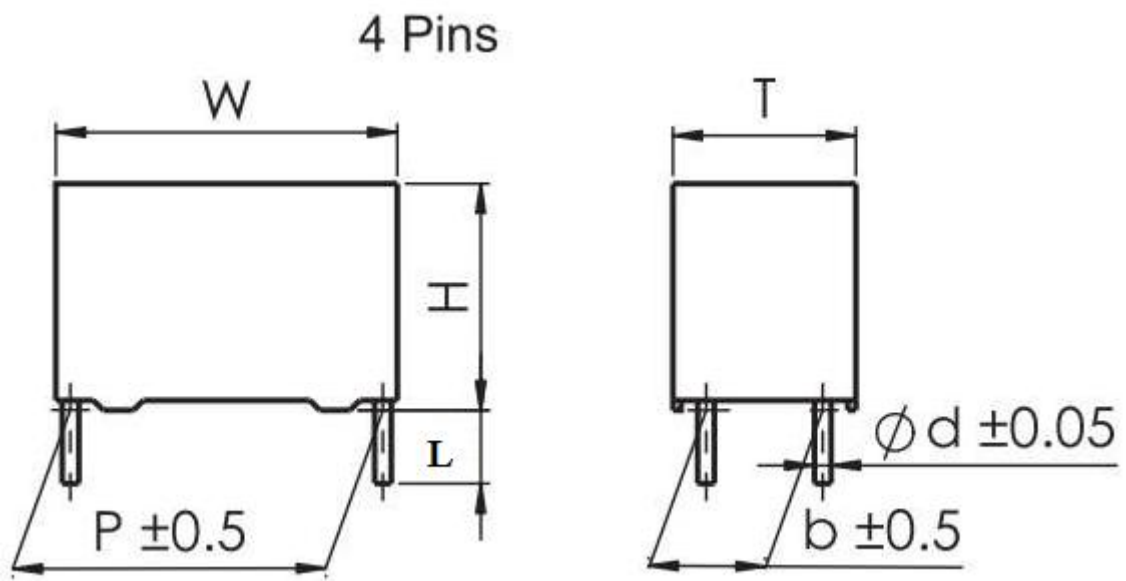
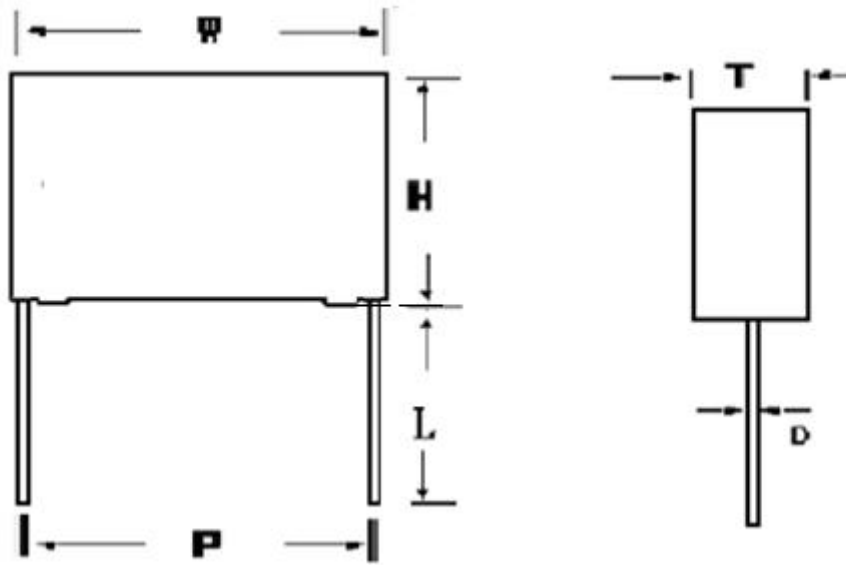

10.DIMENSION:**UNIT: mm**

SYMBOL	CAP	COLO R	W ±1.0	H ±1.0	T ±1.0	P ±1.0	D ±0.0 5	L +5/-10	备注
MPC505K500D01	5.0uF	Grey	32.0	20.0	11.0	27.5	0.8	21.0	
MPX106K500D01	10.0u F	Grey	31.0	25.0	14.0	27.5	0.8	21.0	
MPC335K800D01	3.3uF	Grey	32.0	30.0	15.0	27.5	0.8	21.0	
MPC106K900D01	10.0u F	Grey	32.0	37.0	22.0	27.5	0.8	21.0	四只 脚
MPC105K1000D01	1.0uF	Grey	32.0	20.0	11.0	27.5	0.8	21.0	
MPC405K1000D01	4.0uF	Grey	32.0	30.0	15.0	27.5	0.8	21.0	
MPC684K1000D01	0.68u F	Grey	32.0	20.0	11.0	27.5	0.8	21.0	
MPC205K1100D01	2.0uF	Grey	31.0	25.0	14.0	27.5	0.8	21.0	
MPC105K1200D01	1.0uF	Grey	32.0	20.0	11.0	27.5	0.8	21.0	
MPC126K1200D01	12.0u F	Grey	42.0	45.0	30.0	37.5	0.8	21.0	四只 脚

11. 使用注意事项 Caution

11.1 焊接建议 Soldering Suggestion

为了达到更好的可焊性，建议按照下列的标准；

In order to achieve a better solderability, recommended in accordance with the following criteria

最大的焊接温度 Maximum Soldering Temperature

	T max	Time
预热 Pre-heating	105℃	1min
焊接 Soldering	270℃	4S

11.2 盐雾试验条件 Salt fog test

本产品引线为镀锡铜包钢产品，请过完波峰焊后再进行盐雾试验；

The lead wire of this product is tin-plated copper-coated steel. Please test the salt mist after the wave peak welding.

12. 存储环境及条件 Storage Environment and Conditions

12.1 存储环境 Storage Environment

储存在温度 $\leq 30^{\circ}\text{C}$ ，湿度 $\leq 70\%$ 的情况下，MBB（Moisture Barrier Bag）未打开能够保证 24 个月的储存期。

In the storage temperature are less than 30, humidity less than 70% conditions, MBB（Moisture Barrier Bag）is not open to ensure that the storage period of 24 months.

12.2 存储条件 Storage Condition

由于大气中存在氢氯化物、氢硫化物、硫酸物质等，因此产品储存在空气中，引出端的可焊性会变差。

产品不能暴露在高温高湿状态，必须在 12 的存储环境条件下保存

Due to the presence of hydrogen chloride, hydrogen sulfide, sulfuric acid, etc. in the atmosphere, So the product is stored in the air, solderability of terminations will be poor.

Products can not be exposed to high temperature and high humidity condition, must be stored under 12 of the storage environment.

13. 绿色产品 Green Products

符合 RoHS 标准 In compliance with RoHS

智新电子公司提供的产品均符合 RoHS 2.0 环保指令的要求

JIMSON ELECTRONICS CO., LTD Products are RoHS Compliant.

THE END