



SMCG Plastic-Encapsulate Diodes

RS3A THRU RS3M Fast Recovery Rectifier Diodes

Features

- $I_{F(AV)}$ 3A
- V_{RRM} 50V-1000V
- High surge current capability
- Polarity: Color band denotes cathode

Applications

- Rectifier

Marking

- RS3X
X : From A To M

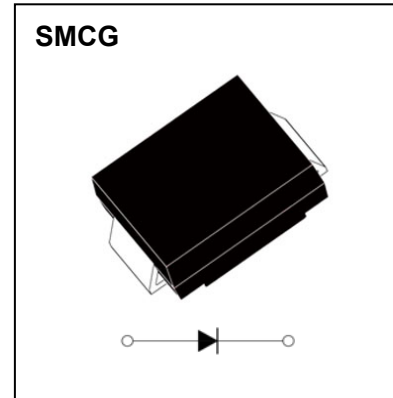

Limiting Values(Absolute Maximum Rating)

Item	Symbol	Unit	Test Conditions	RS3						
				A	B	D	G	J	K	M
Repetitive Peak Reverse Voltage	V_{RRM}	V		50	100	200	400	600	800	1000
Maximum RMS Voltage	V_{RMS}	V		35	70	140	280	420	560	700
Average Forward Current	$I_{F(AV)}$	A	60Hz Half-sine wave, Resistance load, $T_L=110^\circ\text{C}$	3.0						
Surge(Non-repetitive)Forward Current	I_{FSM}	A	60Hz Half-sine wave, 1 cycle, $T_a=25^\circ\text{C}$	100						
Operation Junction and Storage Temperature Range	T_J, T_{STG}	$^\circ\text{C}$		-55 ~ +150						

Electrical Characteristics ($T=25^\circ\text{C}$ Unless otherwise specified)

Item	Symbol	Unit	Test Condition	RS3						
				A	B	D	G	J	K	M
Peak Forward Voltage	V_F	V	$I_F=3.0\text{A}$	1.3						
Maximum reverse recovery time	t_{rr}	ns	$I_F=0.5\text{A}, I_R=1.0\text{A}, I_{ir}=0.25\text{A}$	150			250		500	
Peak Reverse Current	I_{RRM1}	μA	$V_{RM}=V_{RRM}$	$T_a=25^\circ\text{C}$						
	I_{RRM2}			$T_a=100^\circ\text{C}$						
Thermal Resistance(Typical)	$R_{\theta J-A}$	$^\circ\text{C}/\text{W}$	Between junction and ambient	50						
	$R_{\theta J-L}$		Between junction and terminal	15						

Notes:

Thermal resistance from junction to ambient and from junction to lead mounted on P.C.B. with 0.27" x 0.27" (7.0 mm x 7.0 mm) copper pad areas

Typical Characteristics

FIG.1: FORWARD CURRENT DERATING CURVE

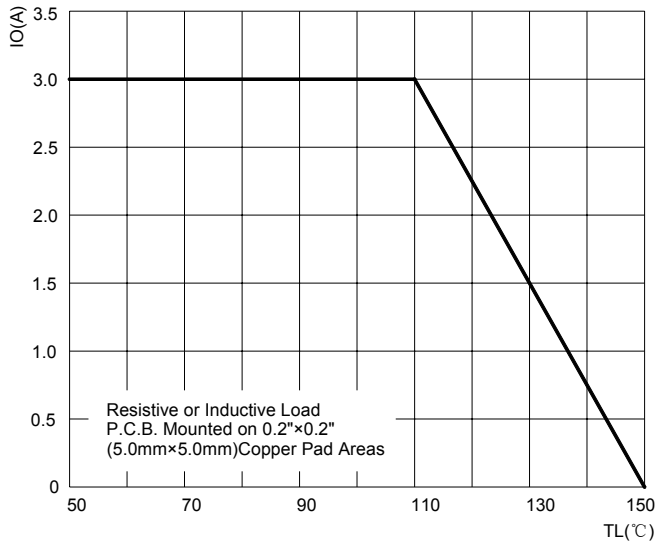

FIG.2: MAXIMUM NON-REPETITIVE FORWARD URGE CURRENT

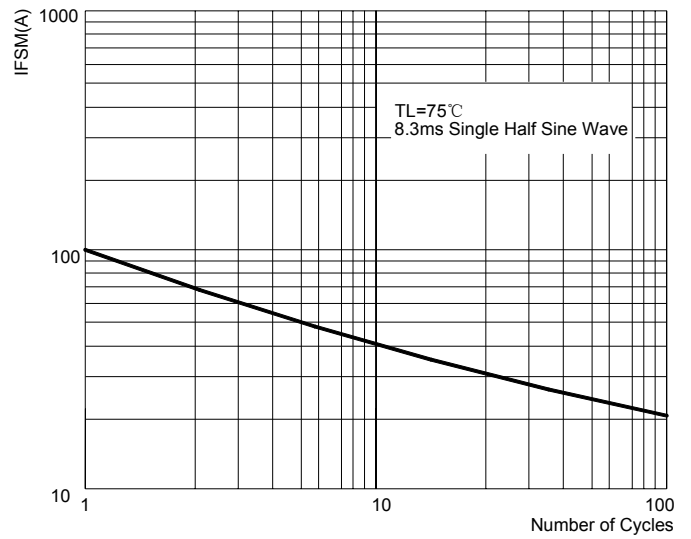

FIG.3: TYPICAL FORWARD CHARACTERISTICS

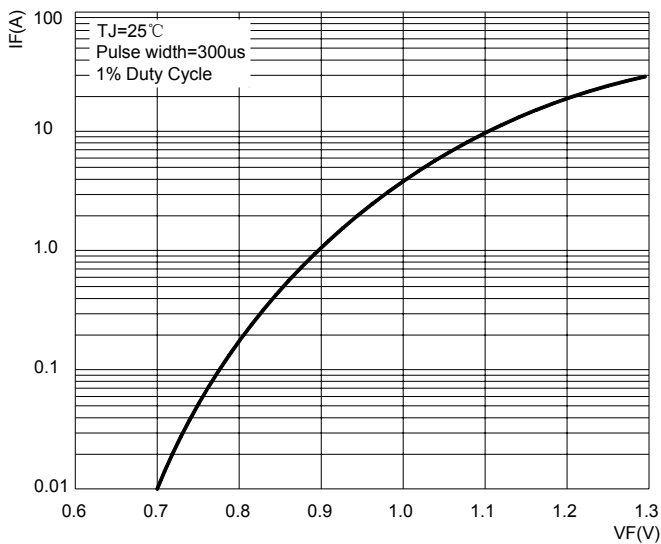

FIG.4: TYPICAL REVERSE CHARACTERISTICS

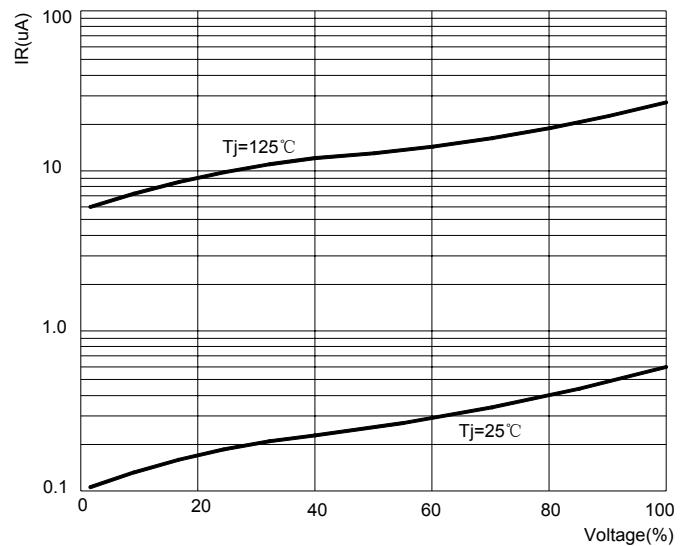
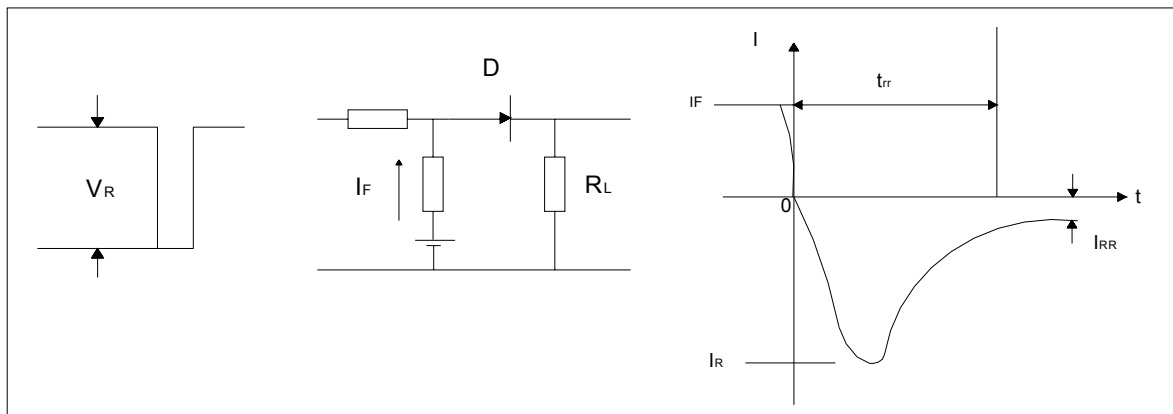

FIG.5: Diagram of circuit and Testing wave form of reverse recovery time



SMCG Package Outline Dimensions



Dimensions in inches and (millimeters)

SMCG Suggested Pad Layout

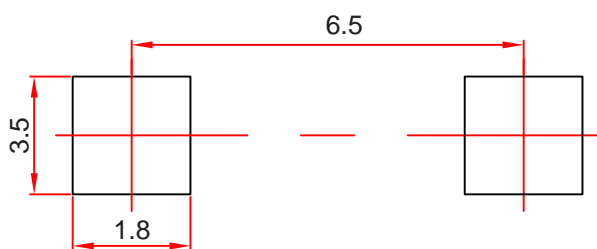

Note:

1. Controlling dimension: in millimeters.
2. General tolerance: ± 0.05 mm.
3. The pad layout is for reference purposes only.

NOTICE

JSCJ reserves the right to make modifications, enhancements, improvements, corrections or other changes without further notice to any product herein. JSCJ does not assume any liability arising out of the application or use of any product described herein.

Reel Taping Specifications For Surface Mount Devices–SMCG



FIG: CONFIGURATION OF SURFACE MOUNTED DEVICES TAPING

ITEM	SYMBOL	SMCG mm(inch)
Carrier width	A	6.05±0.1(0.238±0.004)
Carrier length	B	8.31±0.1(0.327±0.004)
Carrier depth	C	2.70±0.1(0.106±0.004)
Sprocket hole	d	1.55±0.05(0.061±0.002)
Reel outside diameter	D	330±2.0(13±0.079)
Reel inner diameter	D1	75 ±1.0 (2.95 ±0.039)
Feed hole diameter	D2	13±0.5(0.512±0.020)
Sprocket hole position	E	1.75 ±0.1(0.069±0.004)
Punch hole position	F	7.65±0.05(0.301±0.002)
Punch hole pitch	P	8.0±0.1(0.315±0.004)
Sprocket hole pitch	P0	4.0±0.1(0.157±0.004)
Embossment center	P1	2.0±0.1(0.079±0.004)
Total tape thickness	T	0.3 ± 0.1 (0.012±0.004)
Tape width	W	16.0±0.2(0.630±0.008)
Reel width	W1	24.0±2.0(0.945±0.079)

NOTE: Devices are packed in accordance with EIA standard RS-481-A and specification given above.