

# TO-220F Plastic-Encapsulate Transistors

## 2SD2012 TRANSISTOR (NPN)

### FEATURES

- Audio frequency power amplifier applications
- High DC current gain
- Low saturation voltage
- High power dissipation

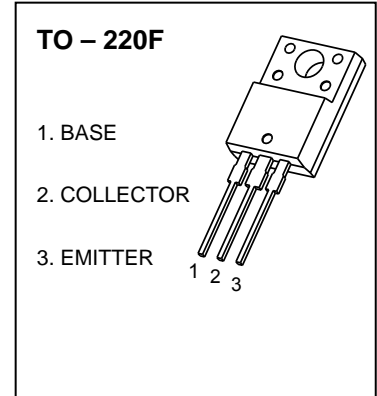

### MARKING

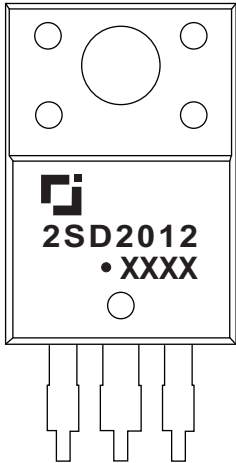

2SD2012=Device code  
Solid dot=Green mold compound device,  
if none, the normal device  
XXXX=Code

### Equivalent Circuit

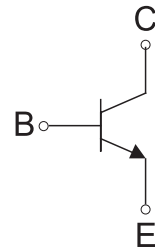

### MAXIMUM RATINGS (T<sub>A</sub>=25°C unless otherwise noted)

Symbol	Parameter	Value	Units
V <sub>CBO</sub>	Collector-Base Voltage	60	V
V <sub>CEO</sub>	Collector-Emitter Voltage	60	V
V <sub>EBO</sub>	Emitter-Base Voltage	7	V
I <sub>C</sub>	Collector Current -Continuous	3	A
P <sub>C</sub>	Collector power dissipation	2	W
T <sub>J</sub> , T <sub>stg</sub>	Operation Junction and Storage Temperature Range	-55-150	°C

**ELECTRICAL CHARACTERISTICS (Tamb=25°C unless otherwise specified)**

Parameter	Symbol	Test conditions	MIN	TYP	MAX	UNIT
Collector-base breakdown voltage	$V_{(BR)CBO}$	$I_C=100\mu A, I_E=0$	60			V
Collector-emitter breakdown voltage	$V_{(BR)CEO}$	$I_C=50mA, I_B=0^{1)}$	60			V
Emitter-base breakdown voltage	$V_{(BR)EBO}$	$I_E=100\mu A, I_C=0$	7			V
Collector cut-off current	$I_{CBO}$	$V_{CB}=60V, I_E=0$			100	$\mu A$
Emitter cut-off current	$I_{EBO}$	$V_{EB}=7V, I_C=0$			100	$\mu A$
DC current gain	$h_{FE1}$	$V_{CE}=5V, I_C=0.5A$	100		320	
	$h_{FE2}$	$V_{CE}=5V, I_C=2A$	20			
Collector-emitter saturation voltage	$V_{CE(sat)}$	$I_C=2A, I_B=0.2A$			1	V
Base-emitter voltage	$V_{BE}$	$V_{CE}=5V, I_C=0.5A$			1	V
Transition frequency	$f_T$	$V_{CE}=5V, I_C=0.5A$		3		MHz
collector capacitance	Cob	$V_{CB}=10V, I_E=0, f=1MHz$		35		pF

# Typical Characteristics

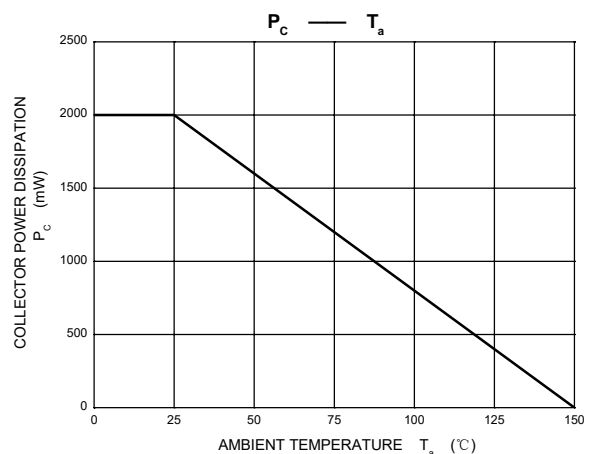
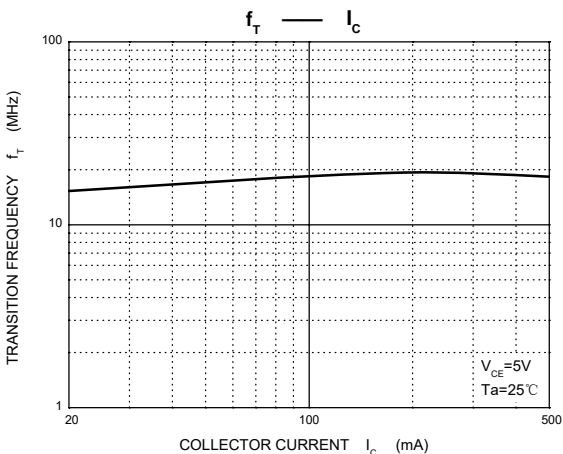
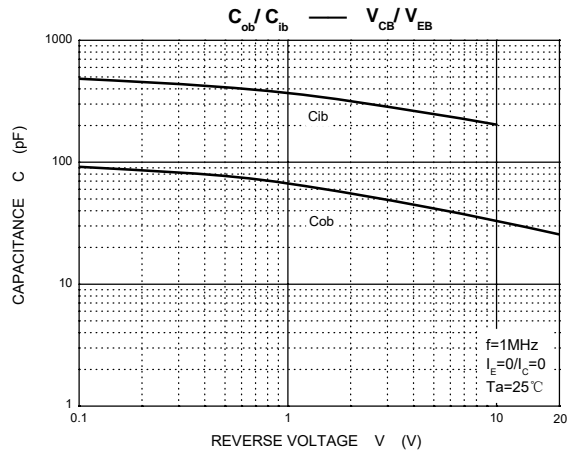
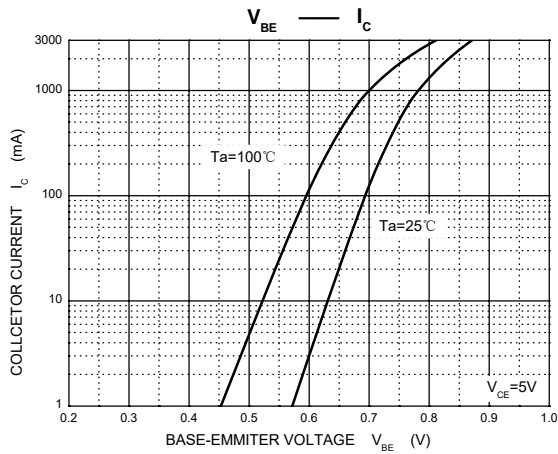
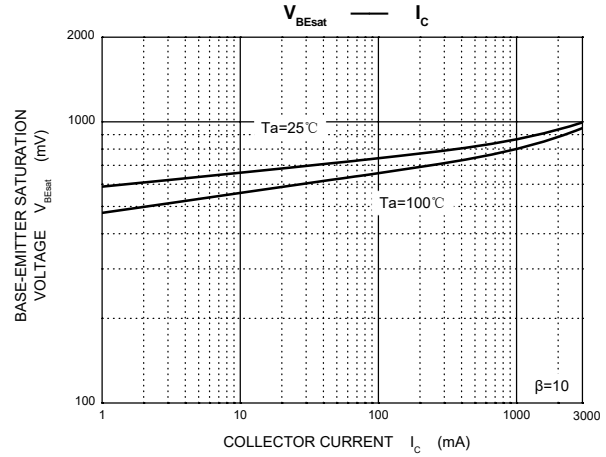
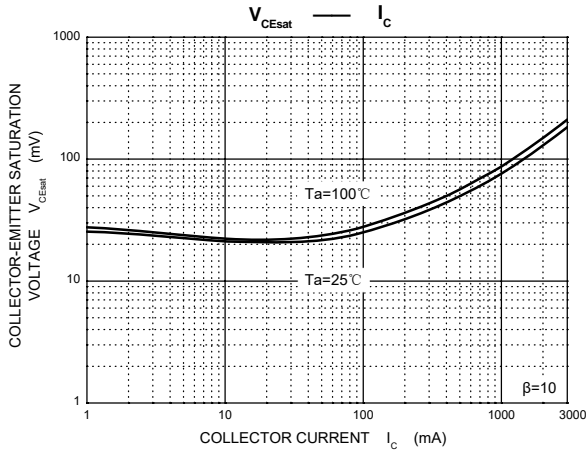
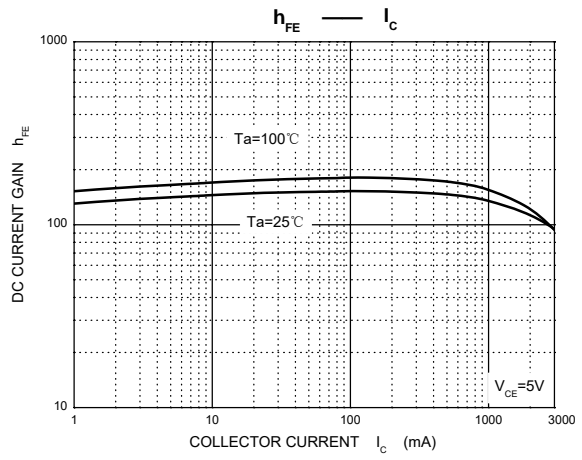
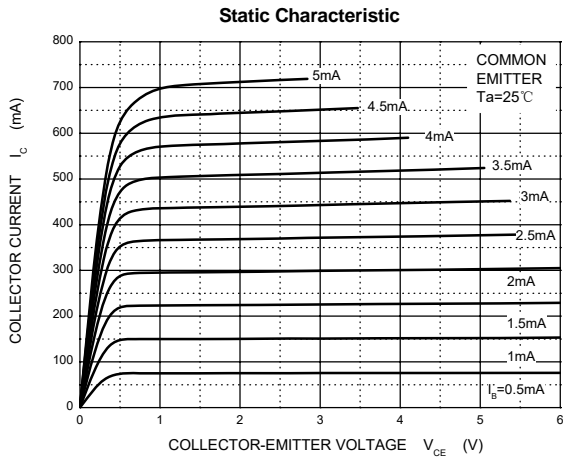

# TO-220F Package Outline Dimensions

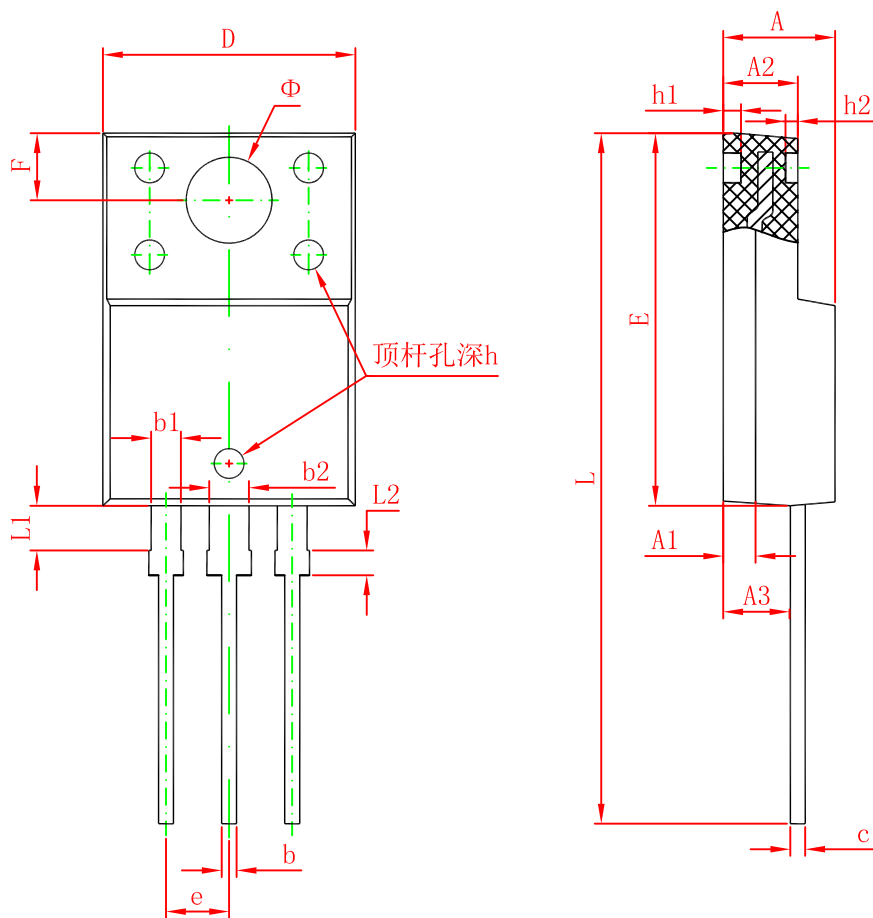

Symbol	Dimensions In Millimeters		Dimensions In Inches	
	Min.	Max.	Min.	Max.
A	4.300	4.700	0.169	0.185
A1	1.300 REF.		0.051 REF.	
A2	2.800	3.200	0.110	0.126
A3	2.500	2.900	0.098	0.114
b	0.500	0.750	0.020	0.030
b1	1.100	1.350	0.043	0.053
b2	1.500	1.750	0.059	0.069
c	0.500	0.750	0.020	0.030
D	9.960	10.360	0.392	0.408
E	14.800	15.200	0.583	0.598
e	2.540 TYP.		0.100 TYP.	
F	2.700 REF.		0.106 REF.	
Φ	3.500 REF.		0.138 REF.	
h	0.000	0.300	0.000	0.012
h1	0.800 REF.		0.031 REF.	
h2	0.500 REF.		0.020 REF.	
L	28.000	28.400	1.102	1.118
L1	1.700	1.900	0.067	0.075
L2	0.900	1.100	0.035	0.043