



BCT2057 1A, Low Dropout, Linear Regulators

BCT2057 1A Low Dropout Linear Regulators

GENERAL DESCRIPTION

The BCT2057 series low-power, low-noise, low-dropout, CMOS linear voltage regulators operate from a 1.6V to 5.5V input voltage. They are the perfect choice for low voltage, low power applications. A low ground current makes this part attractive for battery operated power systems. The BCT2057 series also offer ultra-low dropout voltage to prolong battery life in portable electronics. Output current minimum limit is 1A, and over-current protection limit is set at 1.8A typical.

These devices feature a shutdown function and are offered in active low with auto discharge. The output voltage is preset to voltages in the range of 0.8V to 5.0V. Other features include a low shutdown current, fold-back current limit and thermal shutdown protection.

The BCT2057 is available in Green SOT23-5 or DFN2x2-6L Packages. It operates over an ambient temperature range of -40°C to +85°C.

FEATURES

- Wide Input Voltage Range: 1.6V to 5.5V
- Fixed Outputs of 0.8V,0.9V,1.0V,1.05V,1.1V,1.2V,1.3V,1.35,1.5V,1.8V,2.2V,2.5V,2.8V,3.0V 3.3V and 3.6V
- 1A Current Rating
- Adjustable Output from 0.8V to 5.0V
- Low Dropout Voltage
- Output Current Limit
- Quick output discharge
- Thermal-Overload Protection
- High PSRR(65dB at 1kHz)
- -40°C to 85°C Operating Temperature Range
- Green SOT23-5 or DFN2x2-6L Packages

APPLICATIONS

Cellular Telephones
Cordless Telephones
PCMCIA Cards
Modems
MP3 Player
Hand-Held Instruments
Portable/Battery-Powered Equipment



BCT2057 1A, Low Dropout, Linear Regulators

ORDERING INFORMATION

| Order Number | V _{OUT} (V) | Package Type | Temperature Range | Marking | QTY/Reel |
|-----------------|----------------------|--------------|-------------------|---------|----------|
| BCT2057EUK08-TR | 0.8 | SOT23-5 | -40°C to +85°C | G8XX | 3000 |
| BCT2057EUK09-TR | 0.9 | SOT23-5 | -40°C to +85°C | G9XX | 3000 |
| BCT2057EUK10-TR | 1.0 | SOT23-5 | -40°C to +85°C | G0XX | 3000 |
| BCT2057EUK1A-TR | 1.05 | SOT23-5 | -40°C to +85°C | GAXX | 3000 |
| BCT2057EUK11-TR | 1.1 | SOT23-5 | -40°C to +85°C | G1XX | 3000 |
| BCT2057EUK12-TR | 1.2 | SOT23-5 | -40°C to +85°C | G2XX | 3000 |
| BCT2057EUK13-TR | 1.3 | SOT23-5 | -40°C to +85°C | G3XX | 3000 |
| BCT2057EUK1B-TR | 1.35 | SOT23-5 | -40°C to +85°C | GBXX | 3000 |
| BCT2057EUK15-TR | 1.5 | SOT23-5 | -40°C to +85°C | G5XX | 3000 |
| BCT2057EUK18-TR | 1.8 | SOT23-5 | -40°C to +85°C | G8XX | 3000 |
| BCT2057EUK22-TR | 2.2 | SOT23-5 | -40°C to +85°C | G2XX | 3000 |
| BCT2057EUK25-TR | 2.5 | SOT23-5 | -40°C to +85°C | G5XX | 3000 |
| BCT2057EUK28-TR | 2.8 | SOT23-5 | -40°C to +85°C | G8XX | 3000 |
| BCT2057EUK30-TR | 3.0 | SOT23-5 | -40°C to +85°C | G0XX | 3000 |
| BCT2057EUK33-TR | 3.3 | SOT23-5 | -40°C to +85°C | G3XX | 3000 |
| BCT2057EUK36-TR | 3.6 | SOT23-5 | -40°C to +85°C | G6XX | 3000 |
| BCT2057EUKAJ-TR | ADJ | SOT23-5 | -40°C to +85°C | GJXX | 3000 |
| BCT2057ELT08-TR | 0.8 | DFN2x2-6L | -40°C to +85°C | G8XX | 3000 |
| BCT2057ELT09-TR | 0.9 | DFN2x2-6L | -40°C to +85°C | G9XX | 3000 |
| BCT2057ELT10-TR | 1.0 | DFN2x2-6L | -40°C to +85°C | G0XX | 3000 |
| BCT2057ELT1A-TR | 1.05 | DFN2x2-6L | -40°C to +85°C | GAXX | 3000 |
| BCT2057ELT11-TR | 1.1 | DFN2x2-6L | -40°C to +85°C | G1XX | 3000 |
| BCT2057ELT12-TR | 1.2 | DFN2x2-6L | -40°C to +85°C | G2XX | 3000 |
| BCT2057ELT13-TR | 1.3 | DFN2x2-6L | -40°C to +85°C | G3XX | 3000 |
| BCT2057ELT1B-TR | 1.35 | DFN2x2-6L | -40°C to +85°C | GBXX | 3000 |
| BCT2057ELT15-TR | 1.5 | DFN2x2-6L | -40°C to +85°C | G5XX | 3000 |
| BCT2057ELT18-TR | 1.8 | DFN2x2-6L | -40°C to +85°C | G8XX | 3000 |
| BCT2057ELT22-TR | 2.2 | DFN2x2-6L | -40°C to +85°C | G2XX | 3000 |
| BCT2057ELT25-TR | 2.5 | DFN2x2-6L | -40°C to +85°C | G5XX | 3000 |
| BCT2057ELT28-TR | 2.8 | DFN2x2-6L | -40°C to +85°C | G8XX | 3000 |
| BCT2057ELT30-TR | 3.0 | DFN2x2-6L | -40°C to +85°C | G0XX | 3000 |
| BCT2057ELT33-TR | 3.3 | DFN2x2-6L | -40°C to +85°C | G3XX | 3000 |
| BCT2057ELT36-TR | 3.6 | DFN2x2-6L | -40°C to +85°C | G6XX | 3000 |
| BCT2057ELTAJ-TR | ADJ | DFN2x2-6L | -40°C to +85°C | GJXX | 3000 |



BCT2057 1A, Low Dropout, Linear Regulators

ORDER NUMBER

BCT2057 X XX XX -IR

Tape and Reel

Output Voltages:

08:0.8V

09:0.9V

10:1.0V

1A:1.05V

11:1.1V

12:1.2V

13:1.3V

1B:1.35V

15:1.5V

18:1.8V

22:2.2V

25:2.5V

28:2.8V

30:3.0V

33:3.3V

36:3.6V

AJ:ADJ

Package Type:

UK: SOT23-5

LT: DFN2x2-6L

Operating Temperature Range:

E: -40°C to +85°C

MARKING DESCRIPTION

GVXX

G: Product code.

V: Output Voltage Code. 8:0.8V, 9:0.9V, 0:1.0V, A:1.05V, 1:1.1V, 2:1.2V, 3:1.3V, B:1.35V, 5:1.5V, 8:1.8V, 2:2.2V, 5:2.5V, 8:2.8V, 0:3.0V, 3:3.3V, 6:3.6V, J:ADJ.

XX: Batch code.

PIN CONFIGURATION

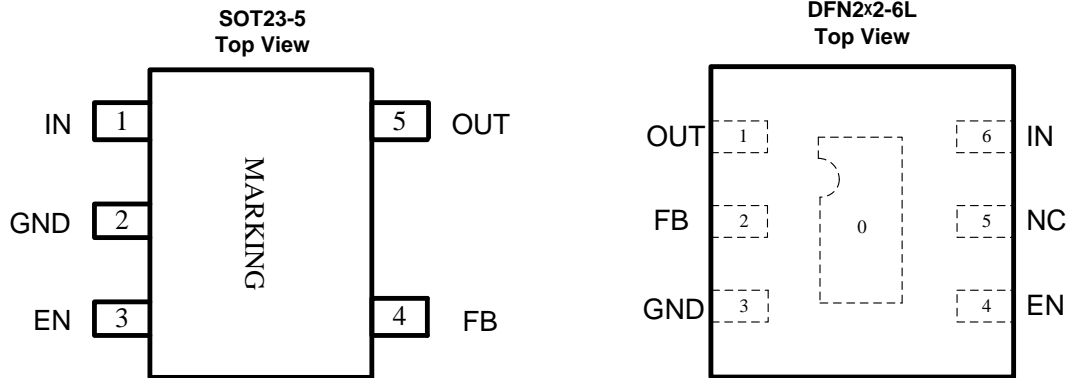

PIN DESCRIPTION

| PIN | | NAME | FUNCTION |
|---------|-----------|------|---|
| SOT23-5 | DFN2x2-6L | | |
| 1 | 6 | IN | Regulator Input. |
| 2 | 3 | GND | Ground |
| 3 | 4 | EN | Enable pin, active high. |
| 4 | 2 | FB | Output voltage adjust pin.(NC when fixed output) |
| 5 | 1 | OUT | Regulator Output. |
| - | 0 | GND | Ground, Thermal pin. |
| - | 5 | NC | No connect. |

TYPICAL APPLICATION CIRCUIT

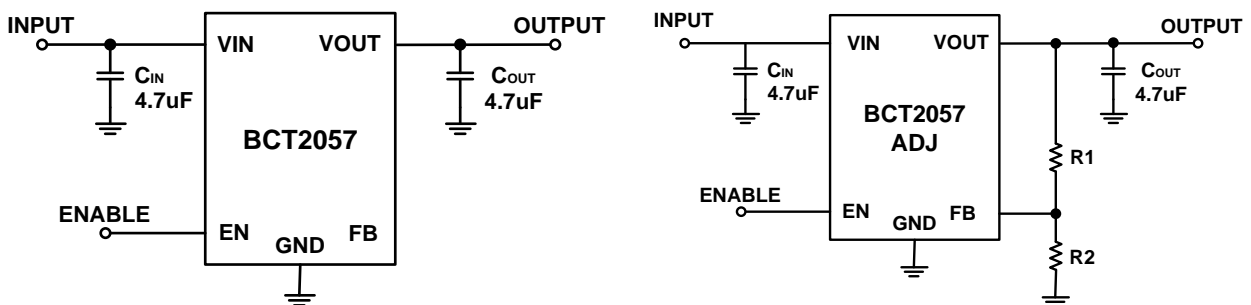



BCT2057 1A, Low Dropout, Linear Regulators

ABSOLUTE MAXIMUM RATINGS

| | |
|---|--------------------------|
| IN to GND..... | -0.3V to 6.5V |
| EN to GND..... | -0.3V to V_{IN} |
| OUT,FB to GND..... | -0.3V to $(V_{IN}+0.3V)$ |
| Output Short-Circuit Duration..... | Infinite |
| Power Dissipation, $P_D@T_A=25^\circ C$ | |
| SOT23-5..... | 0.5W |
| DFN2x2-6L..... | 0.9W |
| Package Thermal Resistance | |
| SOT23-5, θ_{JA} | 260°C/W |
| DFN2x2-6L, θ_{JA} | 140°C/W |
| Junction Temperature..... | 150°C |
| Operating Temperature Range..... | -40°C to +85°C |
| Storage Temperature Range..... | -65°C to 150°C |
| Lead Temperature (Soldering, 10 sec)..... | 260°C |
| ESD Susceptibility HBM..... | 4000V |

NOTE:

Stresses beyond those listed under “Absolute Maximum Ratings” may cause permanent damage to the device. These are stress ratings only, and functional operation of the device at these or any other conditions beyond those indicated in the operational sections of the specifications is not implied. Exposure to absolute maximum rating conditions for extended periods may affect device reliability.

CAUTION

This integrated circuit can be damaged by ESD if you don't pay attention to ESD protection. Broadchip recommends that all integrated circuits be handled with appropriate precautions. Failure to observe proper handling and installation procedures can cause damage. ESD damage can range from subtle performance degradation to complete device failure. Precision integrated circuits may be more susceptible to damage because very small parametric changes could cause the device not to meet its published specifications.

Broadchip reserves the right to make any change in circuit design, specification or other related things if necessary without notice at any time. Please contact Broadchip sales office to get the latest datasheet.

ELECTRICAL CHARACTERISTICS

($V_{IN} = V_{OUT(NOMINAL)} + 0.5V^{(1)}$, $T_A = -40^{\circ}C$ to $+85^{\circ}C$, unless otherwise specified.)

| PARAMETER | SYM | CONDITIONS | MIN | TYP | MAX | UNITS |
|--|-------------------|--|----------------------------|-------|-------|-------------|
| Input Voltage | V_{IN} | | 1.6 | | 5.5 | V |
| Output Voltage Accuracy ⁽¹⁾ | | $I_{OUT} = 1mA$ | -2.0 | | 2.0 | % |
| Feedback Voltage | V_{FB} | $I_{OUT} = 1mA$, BCT2057-ADJ | 0.784 | 0.8 | 0.816 | V |
| Maximum Output Current ⁽¹⁾ | | $V_{IN} = 1.6V$ or $(V_{OUT} + 0.5V)$ | 1 | | | A |
| Current Limit ⁽¹⁾ | I_{LIM} | $V_{IN} = 1.6V$ or $(V_{OUT} + 0.5V)$ | | 1.8 | | A |
| Short-Circuit Current ⁽¹⁾ | I_{SHORT} | $V_{IN} = 1.6V$ or $(V_{OUT} + 0.5V)$ | | 0.6 | | A |
| Ground Pin Current | I_Q | No load, $EN = 2V$ | | 30 | 100 | μA |
| Dropout Voltage ⁽²⁾ | | $I_{OUT} = 600mA$ | $V_{OUT} < 1.2V$ | | 0.65 | V |
| | | | $1.2V \leq V_{OUT} < 2.5V$ | | 0.35 | |
| | | | $V_{OUT} \geq 2.5V$ | | 0.22 | |
| | | $I_{OUT} = 1A$ | $V_{OUT} < 1.2V$ | | 1 | |
| | | | $1.2V \leq V_{OUT} < 2.5V$ | | 0.55 | |
| | | | $V_{OUT} \geq 2.5V$ | | 0.35 | |
| Line Regulation ⁽¹⁾ | ΔV_{LNR} | $V_{IN} = 1.6V$ or $(V_{OUT} + 0.5V)$ to $5.5V$, $I_{OUT} = 1mA$ | | 0.05 | | %/V |
| Load Regulation | ΔV_{LDR} | $I_{OUT} = 1mA$ to $1A$, $C_{OUT} = 4.7\mu F$, $V_{OUT} > 2V$ | | 0.002 | | %mA |
| | | $I_{OUT} = 1mA$ to $1A$, $C_{OUT} = 4.7\mu F$, $V_{OUT} \leq 2V$ | | 0.004 | | |
| Power Supply Rejection Ratio | PSRR | $I_{LOAD} = 50mA$, $C_{OUT} = 4.7\mu F$, $V_{IN} = 2.8V$, $V_{OUT} = 1.8V$ | $f = 217Hz$ | | 65 | dB |
| | | | $f = 1kHz$ | | 60 | |
| SHUTDOWN⁽³⁾ | | | | | | |
| EN Input Threshold | V_{IH} | $V_{IN} = 1.6V$ to $5.5V$, | 1.5 | | | V |
| | V_{IL} | $V_{EN} = -0.3V$ to V_{IN} | | | 0.3 | |
| EN Input Bias Current | $I_{B(SHDN)}$ | $EN = 0V$ or $EN = V_{IN}$ | | 0.01 | 1 | μA |
| Shutdown Supply Current | $I_{Q(SHDN)}$ | $EN = 0.4V$ | | 0.01 | 1 | μA |
| Shutdown Exit Delay ⁽⁴⁾ | | $C_{OUT} = 4.7\mu F$, No Load | | 30 | | μs |
| THERMAL PROTECTION | | | | | | |
| Thermal Shutdown Temperature | T_{SHDN} | | | 150 | | $^{\circ}C$ |
| Thermal Shutdown Hysteresis | ΔT_{SHDN} | | | 15 | | $^{\circ}C$ |

NOTES:

- $V_{IN} = V_{OUT} (NOMINAL) + 0.5V$ or $1.6V$, whichever is greater.
- The dropout voltage is defined as $V_{IN} - V_{OUT}$, when V_{OUT} is 100mV below the value of nominal V_{OUT} .
- $V_{EN} = -0.3V$ to V_{IN}
- Time needed for V_{OUT} to reach 90% of final value.

TYPICAL PERFORMANCE CHARACTERISTICS

$V_{EN} = V_{IN}$, $C_{IN} = 4.7\mu F$, $C_{OUT} = 4.7\mu F$, $T_A = +25^\circ C$, unless otherwise noted.

Output Voltage vs. Input Voltage

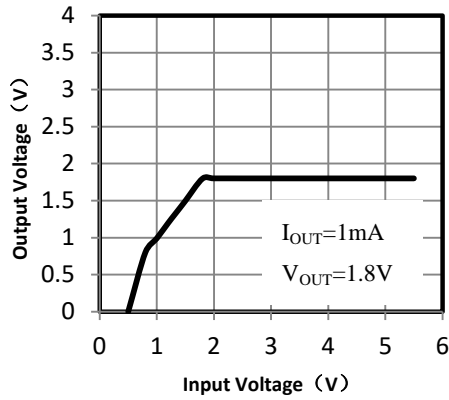

Output Voltage vs. Input Voltage

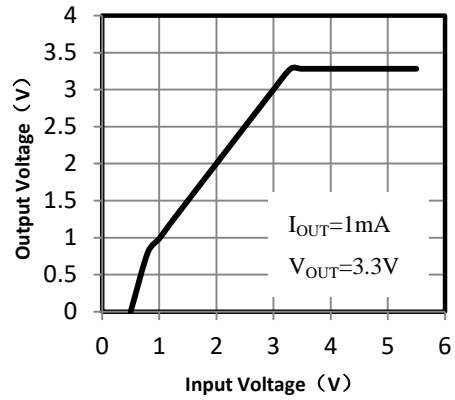

Load Regulation

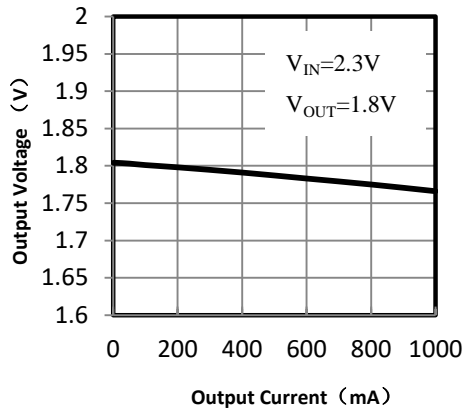

Load Regulation

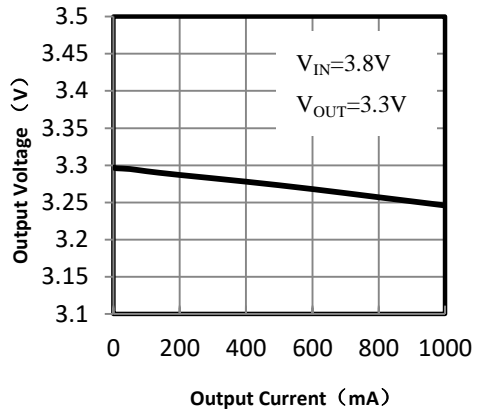

Supply Pin Current vs. Input Voltage

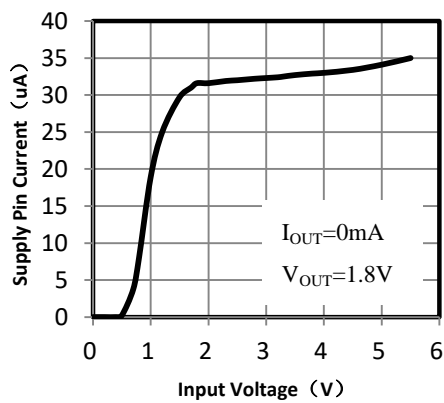

Supply Pin Current vs. Input Voltage

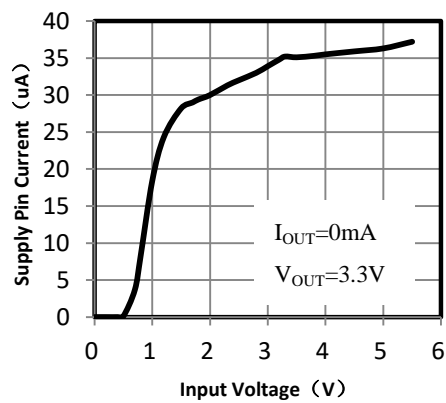

TYPICAL PERFORMANCE CHARACTERISTICS (Continued)

$V_{EN} = V_{IN}$, $C_{IN} = 4.7\mu F$, $C_{OUT} = 4.7\mu F$, $T_A = +25^\circ C$, unless otherwise noted.

Dropout Voltage vs. Output Current

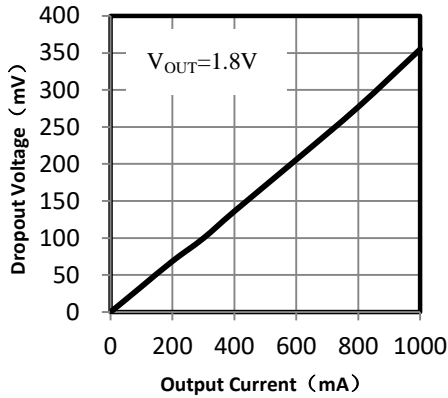

Dropout Voltage vs. Output Current

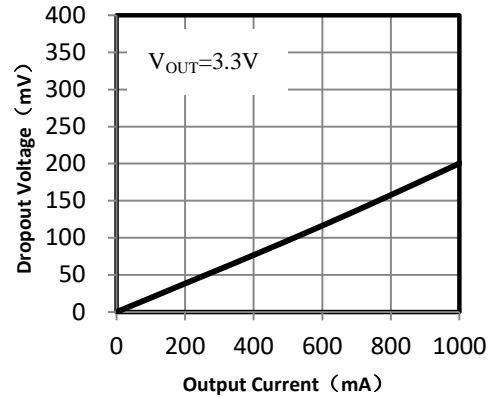

Ground Pin Current vs. Output Current

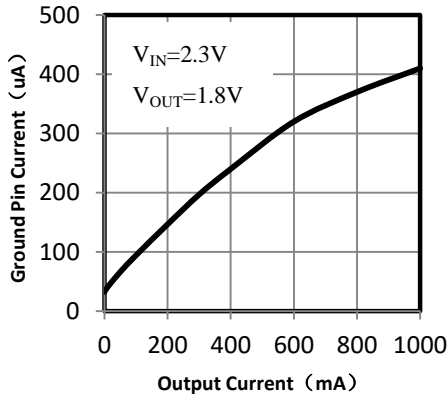

Ground Pin Current vs. Output Current

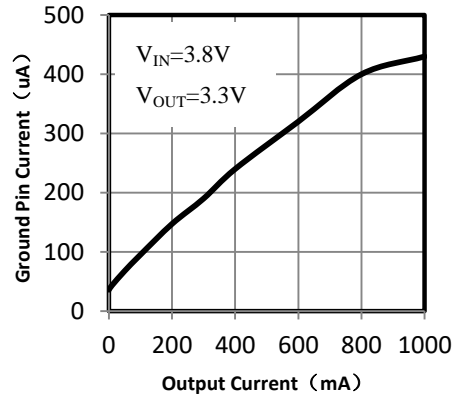

Output Voltage vs. Temperature

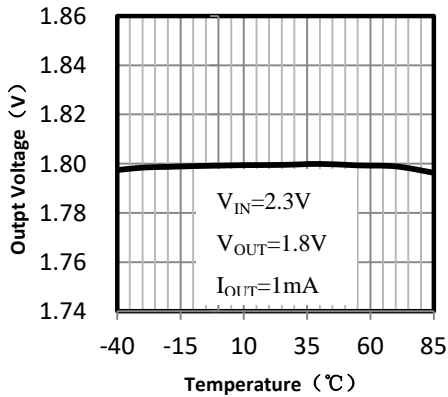

Output Voltage vs. Temperature

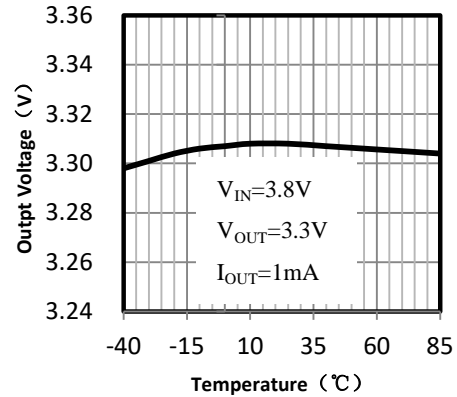

TYPICAL PERFORMANCE CHARACTERISTICS (Continued)

$V_{EN} = V_{IN}$, $C_{IN} = 4.7\mu F$, $C_{OUT} = 4.7\mu F$, $T_A = +25^\circ C$, unless otherwise noted.

Supply Pin Current vs. Temperature

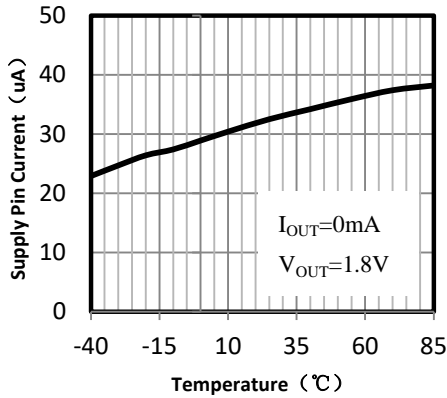

Supply Pin Current vs. Temperature

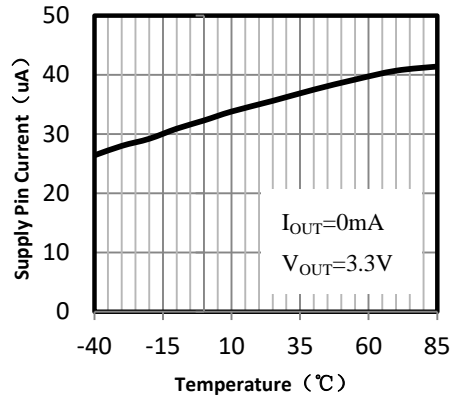

Power Supply Rejection Ratio vs. Frequency

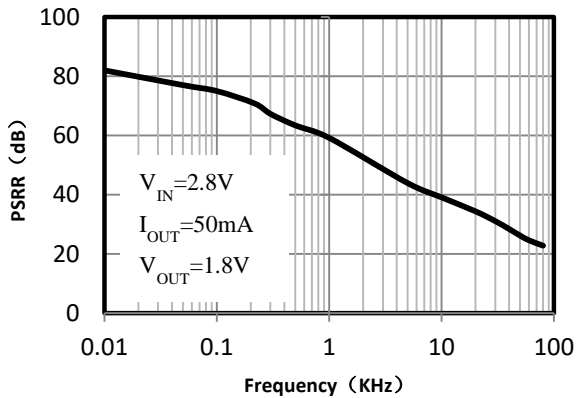

Power Supply Rejection Ratio vs. Frequency

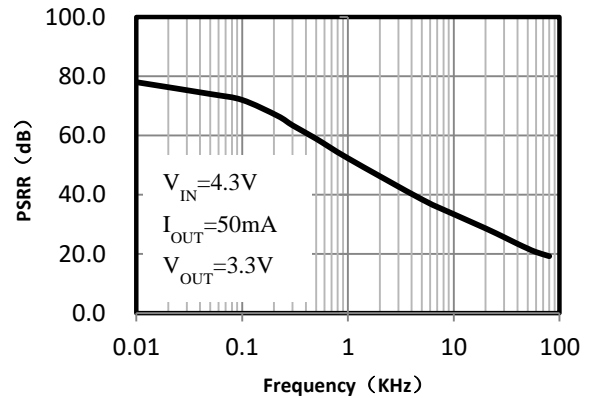

Start up from EN ($V_{OUT}=1.8V$)

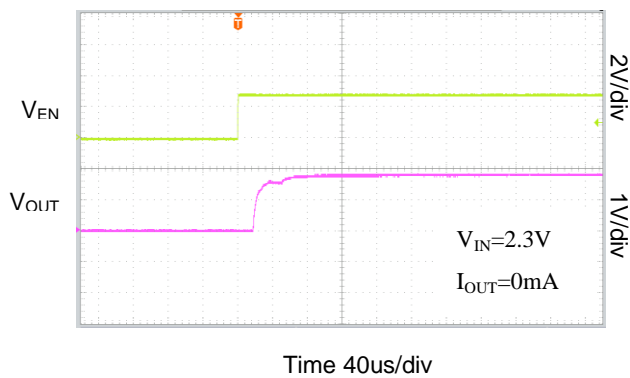

Start up from EN ($V_{OUT}=3.3V$)

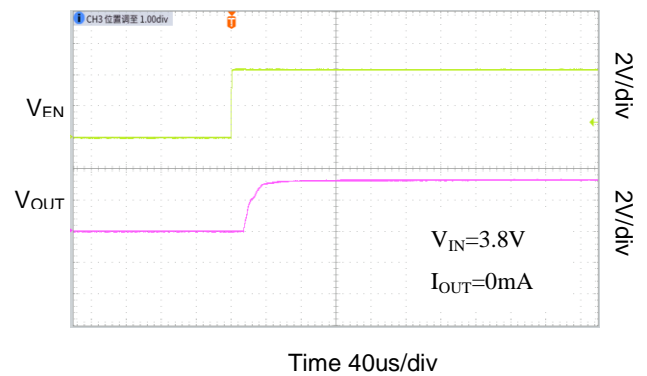

TYPICAL PERFORMANCE CHARACTERISTICS

$V_{EN} = V_{IN}$, $C_{IN} = 4.7\mu F$, $C_{OUT} = 4.7\mu F$, $T_A = +25^\circ C$, unless otherwise noted.

Shutdown from EN ($V_{OUT}=1.8V$)

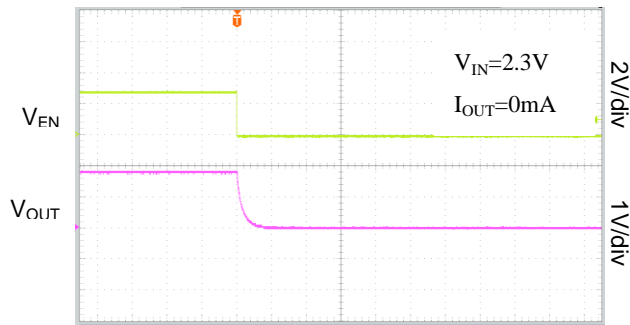

Time 4ms/div

Shutdown from EN ($V_{OUT}=3.3V$)

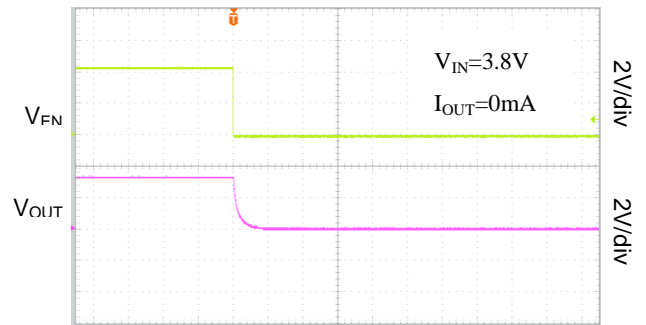

Time 4ms/div

Line Transient Response ($V_{OUT}=1.8V$)

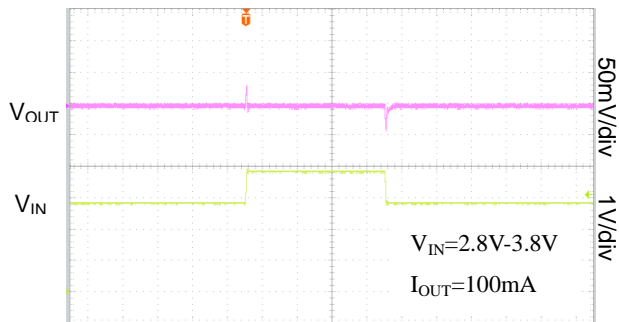

Time 200us/div

Line Transient Response ($V_{OUT}=3.3V$)

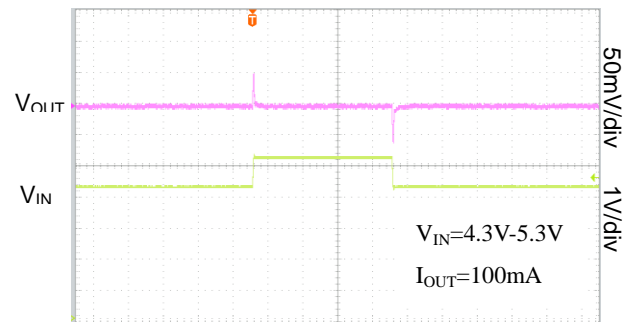

Time 200us/div

Load Transient Response ($V_{OUT}=1.8V$)

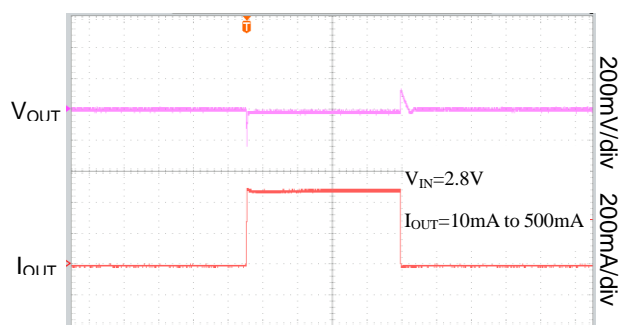

Time 200us/div

Load Transient Response ($V_{OUT}=3.3V$)

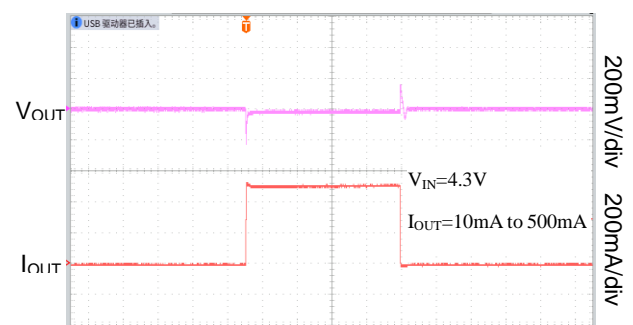

Time 200us/div

APPLICATION NOTE

Programming the BCT2057 Adjustable LDO regulator

The output voltage of the BCT2057 adjustable regulator is programmed using an external resistor divider as show in Figure as below:

$$V_{OUT} = V_{FB} \times \left(1 + \frac{R1}{R2}\right)$$

Where:

$$V_{FB}=0.8V$$

Resistors R1 and R2 should be chosen for approximately 50uA divider current. Lower value resistors can be used for improved noise performance, but the solution consumes more power.

Enable Function

The BCT2057 features an LDO regulator enable/disable function. To assure the LDO regulator will switch on; the EN turn on control level must be greater than 1.5 volts. The LDO regulator will go into the shutdown mode when the voltage on the EN pin falls below 0.3 volts. For to protect the system, the BCT2057 have a quick discharge function. If the enable function is not needed in a specific application, it may be tied to VIN to keep the LDO regulator in a continuously on state.

Thermal Considerations

Thermal protection limits power dissipation in BCT2057. When the operation junction temperature exceeds 150°C, the OTP circuit starts the thermal shutdown function turn the pass element off. The pass element turns on again after the junction temperature cools by 15°C.

For continue operation, do not exceed absolute maximum operation junction temperature 150°C. The power dissipation definition in device is:

$$P_D = (V_{IN}-V_{OUT}) \times I_{OUT} + V_{IN} \times I_Q$$

The maximum power dissipation depends on the thermal resistance of IC package, PCB layout, the rate of surroundings airflow and temperature difference between junction to ambient. The maximum power dissipation can be calculated by following formula:

$$P_D(\text{MAX}) = (T_J(\text{MAX}) - T_A) / \theta_{JA}$$

Where $T_J(\text{MAX})$ is the maximum operation junction temperature 150°C, T_A is the ambient temperature and the θ_{JA} is the junction to ambient thermal resistance. For recommended operating conditions specification of BCT2057, where $T_J(\text{MAX})$ is the maximum junction temperature of the die



BCT2057 1A, Low Dropout, Linear Regulators

(150°C) and T_A is the maximum ambient temperature. The junction to ambient thermal resistance (θ_{JA} is layout dependent) for SOT23-5 package is 260°C/W, DFN2x2-6L package is 140°C/W, on standard JEDEC 51-3 thermal test board. The maximum power dissipation at $T_A = 25^\circ\text{C}$ can be calculated by following formula:

$$P_D(\text{MAX}) = (150^\circ\text{C} - 25^\circ\text{C}) / 140 = 893\text{mW (DFN2x2-6L)}$$

$$P_D(\text{MAX}) = (150^\circ\text{C} - 25^\circ\text{C}) / 260 = 481\text{mW (SOT23-5)}$$

The maximum power dissipation depends on operating ambient temperature for fixed $T_J(\text{MAX})$ and thermal resistance θ_{JA} . It is also useful to calculate the junction of temperature of the BCT2057 under a set of specific conditions. In this example let the Input voltage $V_{IN} = 3.3\text{V}$, the output current $I_o = 1000\text{mA}$ and the case temperature $T_A = 40^\circ\text{C}$ measured by a thermal couple during operation. The power dissipation for the $V_o = 2.8\text{V}$ version of the BCT2057 can be calculated as:

$$P_D = (3.3\text{V} - 2.8\text{V}) \times 1000\text{mA} + 3.3\text{V} \times 100\mu\text{A} \\ = 500.33\text{mW}$$

And the junction temperature, T_J , can be calculated as follows:

$$T_J = T_A + P_D \times \theta_{JA} = 40^\circ\text{C} + 0.5\text{W} \times 140^\circ\text{C/W (DFN2x2-6L)} \\ = 40^\circ\text{C} + 70^\circ\text{C} = 110^\circ\text{C} < T_J(\text{MAX}) = 150^\circ\text{C}$$

For this operating condition, T_J is lower than the absolute maximum operating junction temperature, 150°C, so it is safe to use the BCT2057 in this configuration.

PACKAGE OUTLINE DIMENSIONS

SOT23-5

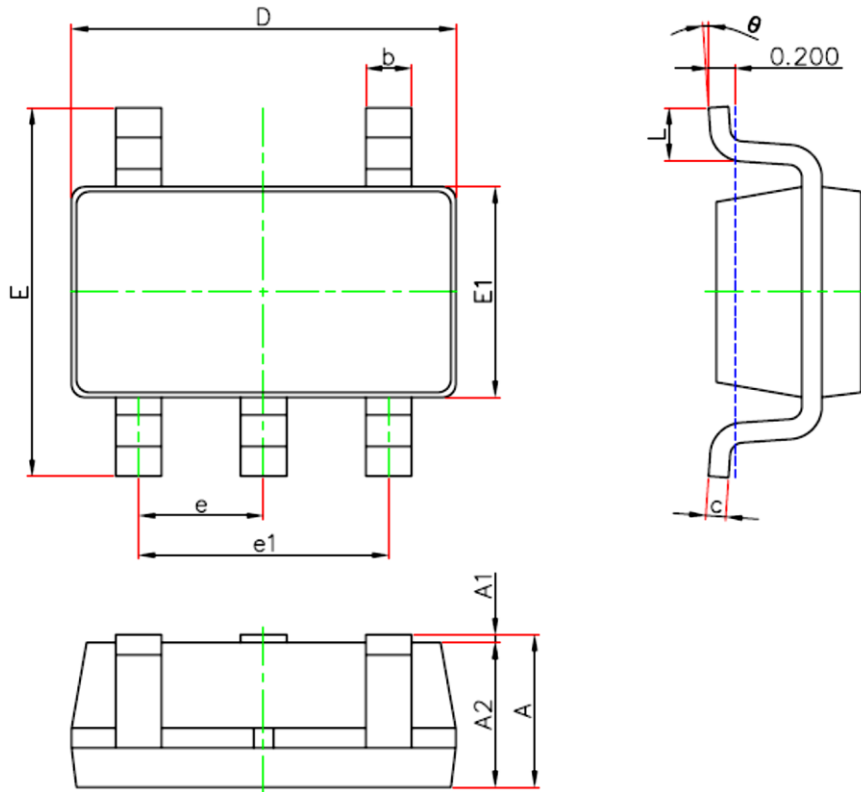

| Symbol | Dimensions In Millimeters | |
|--------|---------------------------|------|
| | Min | Max |
| A | 1.05 | 1.3 |
| A1 | 0 | 0.15 |
| A2 | 1.05 | 1.15 |
| b | 0.28 | 0.5 |
| c | 0.1 | 0.23 |
| D | 2.82 | 3.02 |
| E1 | 1.5 | 1.7 |
| E | 2.65 | 3.05 |
| e | 0.95(BSC) | |
| e1 | 1.8 | 2 |
| L | 0.3 | 0.6 |
| θ | 0 | 8° |

SOT23-5 Surface Mount Package

Package Information

DFN2x2-6L

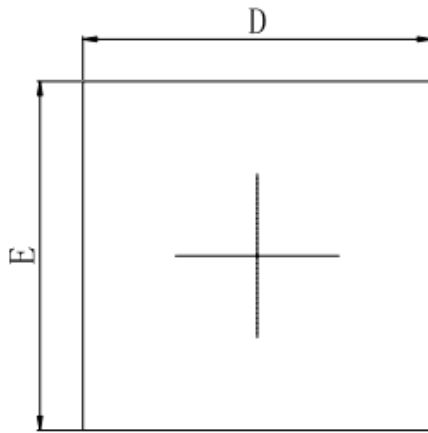

TOP VIEW

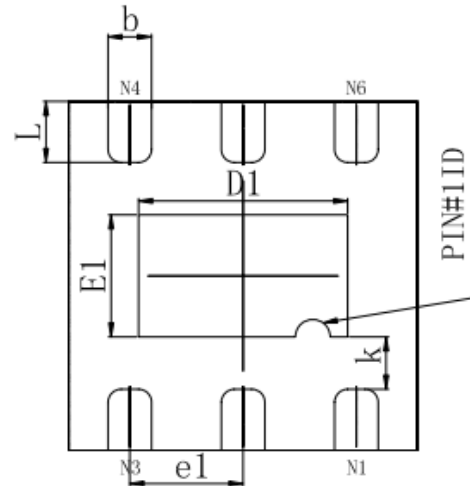

BOTTOM VIEW

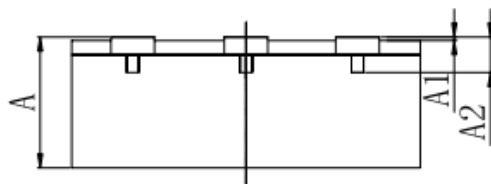

SIDE VIEW

| Symbol | Dimensions In Millimeters | | Dimensions In Inches | |
|--------|---------------------------|-------|----------------------|-------|
| | Min. | Max. | Min. | Max. |
| A | 0.700 | 0.800 | 0.028 | 0.031 |
| A1 | 0.000 | 0.050 | 0.000 | 0.002 |
| A2 | 0.203REF. | | 0.008REF. | |
| D | 1.950 | 2.050 | 0.077 | 0.081 |
| E | 1.950 | 2.050 | 0.077 | 0.081 |
| D1 | 1.150 | 1.250 | 0.045 | 0.049 |
| E1 | 0.650 | 0.750 | 0.026 | 0.030 |
| b | 0.200 | 0.300 | 0.008 | 0.012 |
| e1 | 0.650TYP. | | 0.026TYP. | |
| k | 0.200MIN. | | 0.008MIN. | |
| L | 0.300 | 0.400 | 0.012 | 0.016 |

PCB Layout Pattern (Unit: mm)

SOT23-5

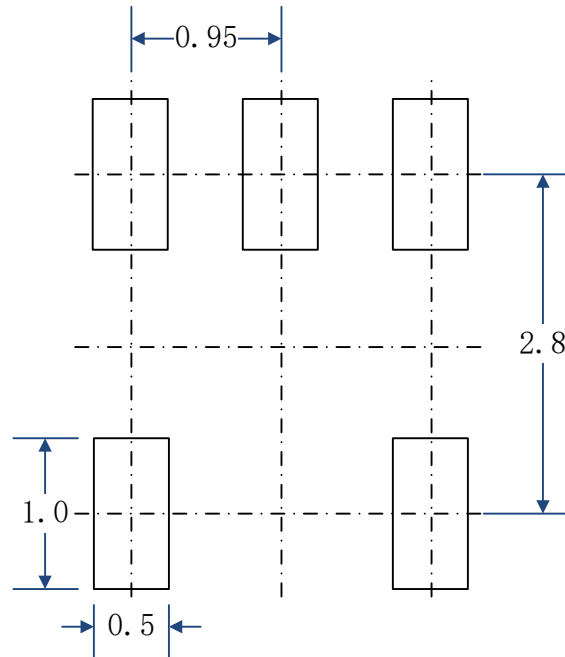

DFN2x2-6L

