

General Description

The LMV358 is a single supply, low power CMOS dual operational amplifier; these amplifiers offer bandwidth of 1MHz, rail-to-rail inputs and outputs, and single-supply operation from 2.5V to 5.5V. The embedded anti -RF filter can significantly increase the RF immunity without extra components. Typical low quiescent supply current of 80µA in dual operational amplifiers within one chip and very low input bias current of 10pA make the devices an ideal choice for low offset, low power consumption and high impedance applications such as smoke detectors, photodiode amplifiers, and other sensors.

The LMV358 is available in MSOP-8L packages.

The extended temperature range of -40°C to $+125^{\circ}\text{C}$ over all supply voltages offers additional design flexibility.

Features

- Single-Supply Operation from +2.5V ~ +5.5V
- Rail-to-Rail Input / Output
- Gain-Bandwidth Product: 1MHz (Typ.)
- Low Input Bias Current: 10pA (Typ.)
- Low Offset Voltage: 5mV (Max.)
- Quiescent Current: 40µA per Amplifier (Typ.)
- Operating Temperature: -40°C ~ $+125^{\circ}\text{C}$
- Available in MSOP-8L
- Shipping Qty : 3000pcs/7Inch Tape & Reel

Applications

- Portable Equipment
- Mobile Communications
- Smoke Detector
- Medical Instrumentation
- Battery-Powered Instruments
- Sensor Interface
- Handheld Test Equipment

Pin Assignments

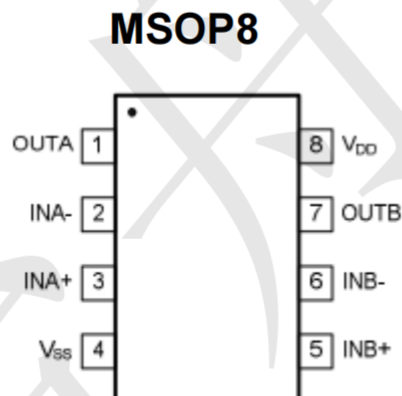

Marking:

LMV358IDGKR-P(MSOP8)



Electrical Characteristics

Absolute Maximum Ratings

Condition	Min	Max
Power Supply Voltage (VDD to Vss)	-0.5V	+7V
Analog Input Voltage (IN+ or IN-)	Vss-0.5V	VDD+0.5V
PDB Input Voltage	Vss-0.5V	+7V
Operating Temperature Range	-40°C	+125°C
Junction Temperature	+150°C	
Storage Temperature Range	-65°C	+150°C
Lead Temperature (soldering, 10sec)	+300°C	
Package Thermal Resistance (TA=+25°C)		
SOP-8L, θ_{JA}	130°C	
MSOP-8L, θ_{JA}	210°C	

Note: Stress greater than those listed under Absolute Maximum Ratings may cause permanent damage to the device. This is a stress rating only and functional operation of the device at these or any other conditions outside those indicated in the operational sections of this specification are not implied. Exposure to absolute maximum rating conditions for extended periods may affect reliability.

Electrical Characteristics

($V_{DD} = +5V$, $V_{SS} = 0V$, $V_{CM} = 0V$, $V_{OUT} = V_{DD}/2$, $R_L = 100k\Omega$ tied to $V_{DD}/2$, $SHDNB = V_{DD}$, $T_A = -40^\circ C$ to $+125^\circ C$, unless otherwise noted. Typical values are at $T_A = +25^\circ C$.) (Notes 1)

Parameter	Symbol	Conditions	Min.	Typ.	Max.	Units
Supply-Voltage Range	V_{DD}	Guaranteed by the PSRR test	2.5	-	5.5	V
Quiescent Supply Current (per Amplifier)	I_Q	$V_{DD} = 5V$	30	40	60	μA
Input Offset Voltage	V_{OS}		-	0.5	± 5	mV
Input Offset Voltage Tempco	$\Delta V_{OS}/\Delta T$		-	2	-	$\mu V/^\circ C$
Input Bias Current	I_B	(Note 2)	-	10	-	pA
Input Offset Current	I_{OS}	(Note 2)	-	10	-	pA
Input Common-Mode Voltage Range	V_{CM}		-0.1	-	$V_{DD}+0.1$	V
Common-Mode Rejection Ratio	CMRR	$V_{DD}=5.5V_{SS}=0.1V V_{CM} V_{DD}+0.1V$	55	65	-	dB
		$V_{SS}\leq V_{CM}\leq 5V$	60	80	-	dB
Power-Supply Rejection Ratio	PSRR	$V_{DD} = +2.5V$ to $+5.5V$	75	94	-	dB
Open-Loop Voltage Gain	A_V	$V_{DD}=5V, R_L=100k\Omega$, $0.05V\leq V_O\leq 4.95V$	100	110	-	dB
		$V_{DD}=5V, R_L=5k\Omega$, $0.05V\leq V_O\leq 4.95V$	70	80	-	dB
Output Voltage Swing	V_{OUT}	$ V_{IN+}-V_{IN-} \leq 10mV V_{DD}-V_{OH}$	-	6	-	mV
		$R_L = 100k\Omega$ to $V_{DD}/2$ $V_{OL}-V_{SS}$	-	6	-	mV
		$ V_{IN+}-V_{IN-} \leq 10mV V_{DD}-V_{OH}$	-	60	-	mV
		$R_L = 5k\Omega$ to $V_{DD}/2$ $V_{OL}-V_{SS}$	-	60	-	mV
Output Short-Circuit Current	I_{SC}	Sinking or Sourcing	-	± 20	-	mA
Gain Bandwidth Product	GBW	$A_V = +1V/V$	-	1	-	MHz
Slew Rate	SR	$A_V = +1V/V$	-	0.6	-	V/ μs
Settling Time	t_s	To 0.1%, $V_{OUT} = 2V$ step $A_V = +1V/V$	-	5	-	μs
Over Load Recovery Time		$V_{IN} \times Gain = V_S$	-	2	-	μs
Input Voltage Noise Density	e_n	$f = 10kHz$	-	20	-	nV/\sqrt{Hz}

Note 1: All devices are 100% production tested at $T_A = +25^\circ C$; all specifications over the automotive temperature range is guaranteed by design, not production tested.

Note 2: Parameter is guaranteed by design.



Typical characteristics

At $T_A=+25^{\circ}\text{C}$, $R_L=100\text{ k}\Omega$ connected to $V_S/2$ and $V_{OUT}=V_S/2$, unless otherwise noted.

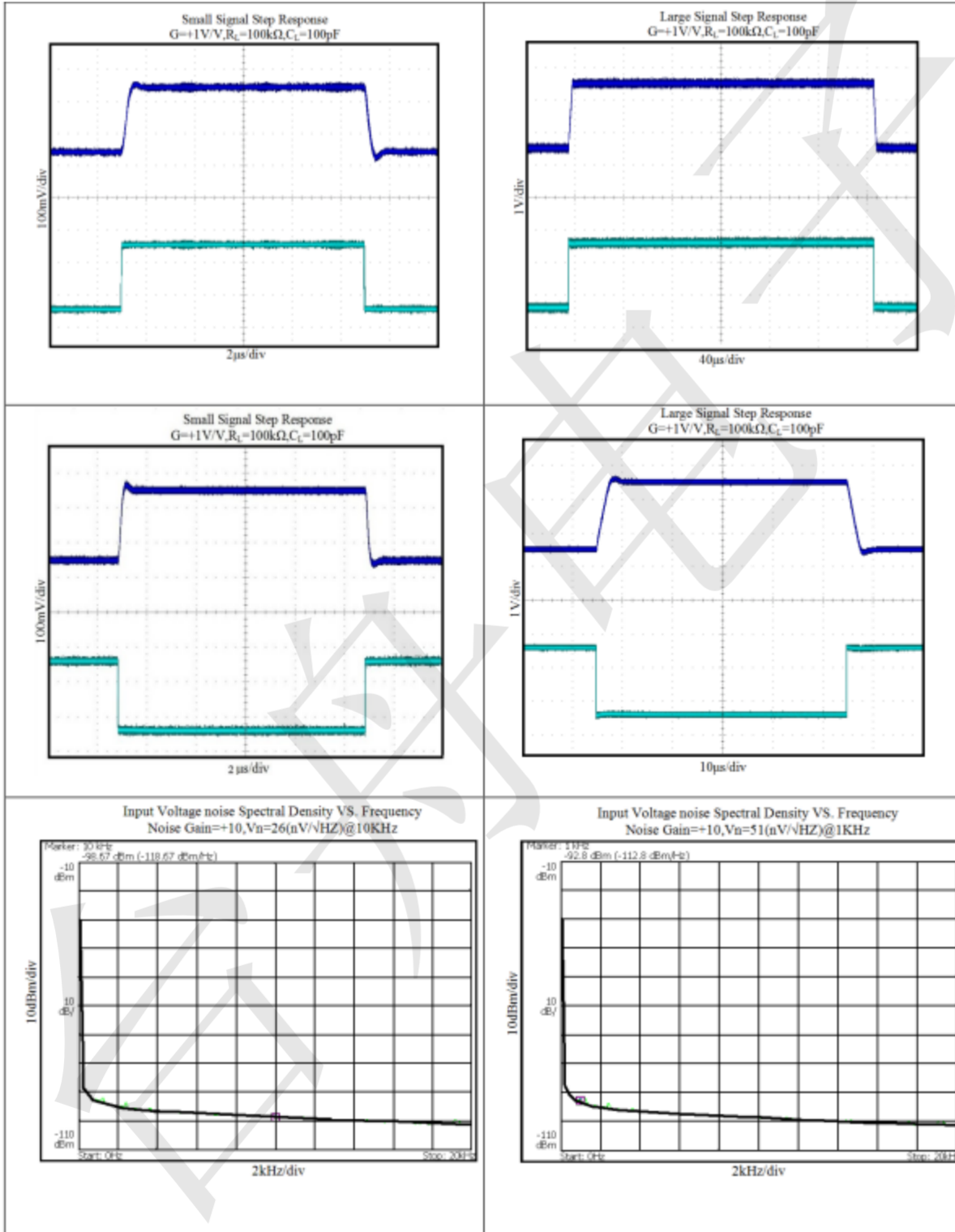



At $T_A=+25^\circ\text{C}$, $R_L=100\text{ k}\Omega$ connected to $V_S/2$ and $V_{OUT}=V_S/2$, unless otherwise noted.

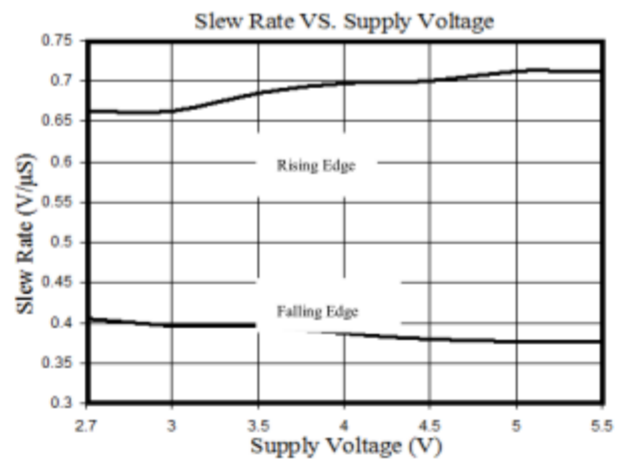
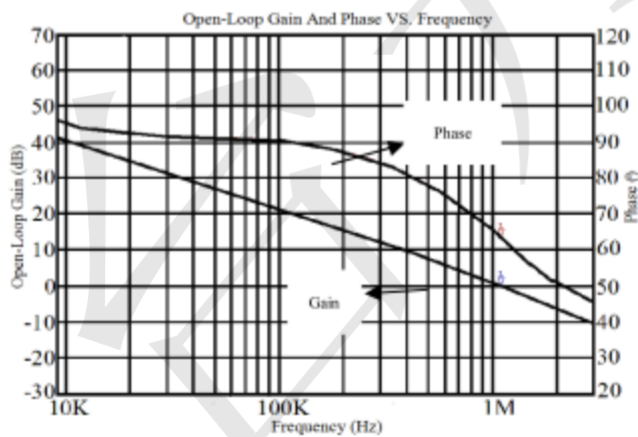
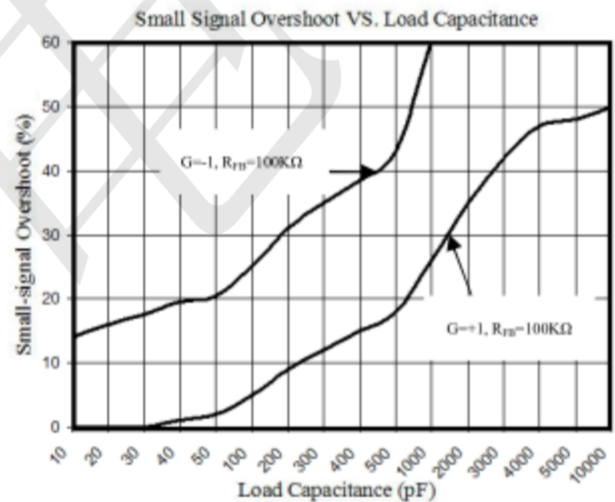
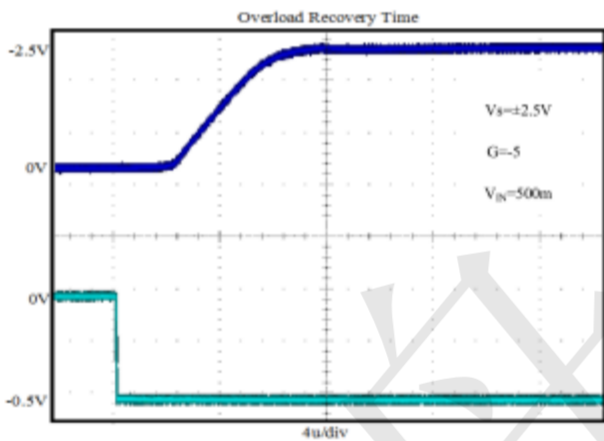
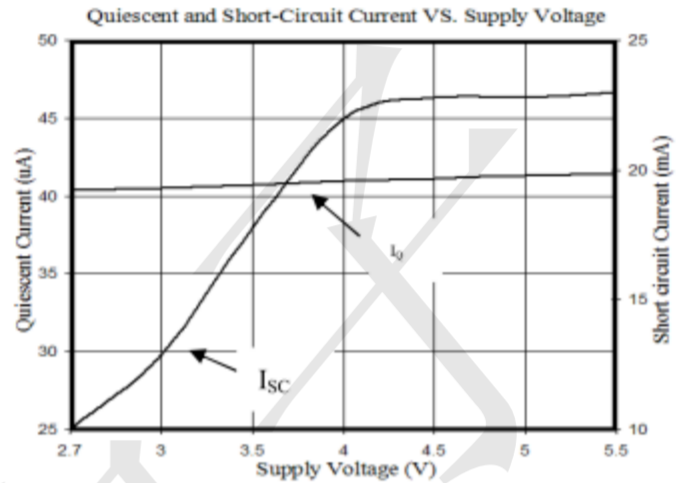
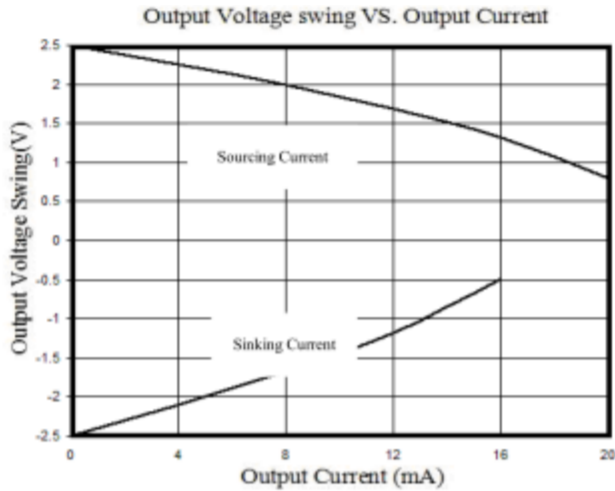



Package Information

MSOP-8L

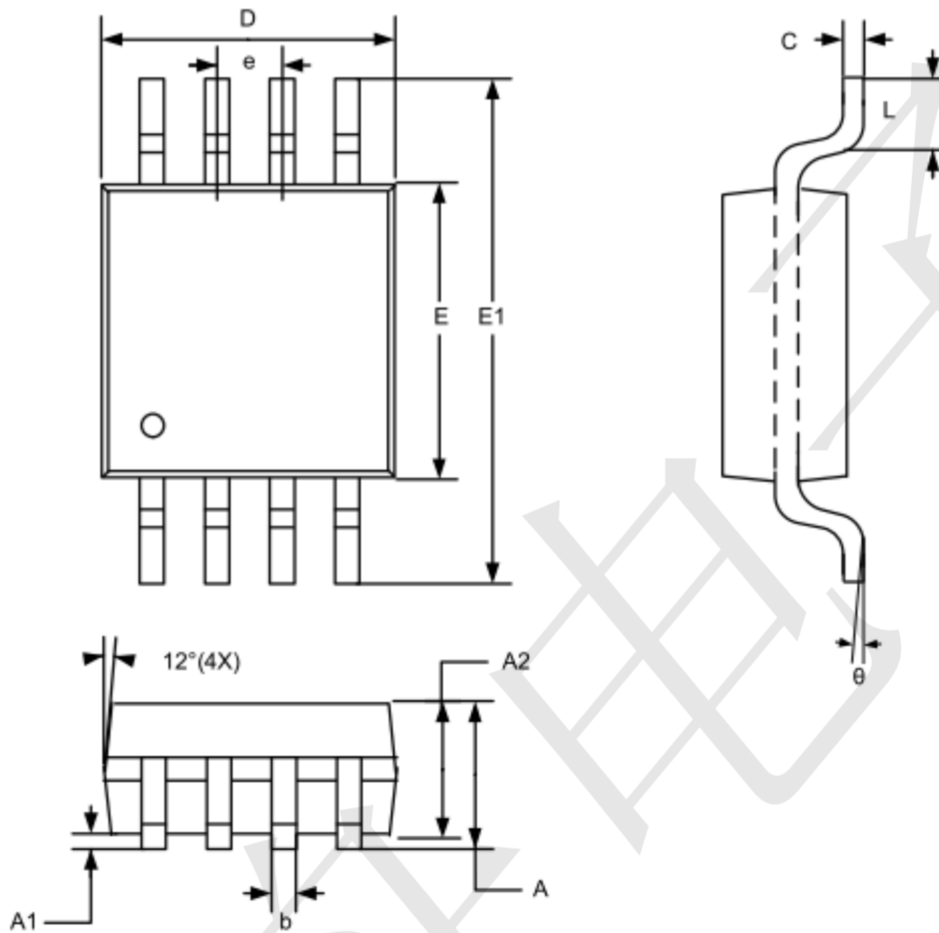

SYMBOLS	DIMENSIONS IN MILLIMETERS			DIMENSIONS IN INCHES		
	MIN	NOM	MAX	MIN	NOM	MAX
A	--	--	1.10	--	--	0.043
A1	0.05	--	0.15	0.002	--	0.006
A2	0.75	0.85	0.95	0.030	0.033	0.037
b	0.25	--	0.40	0.010	--	0.016
C	0.13	--	0.23	0.005	--	0.009
D	2.90	3.00	3.10	0.114	0.118	0.122
E	2.90	3.00	3.10	0.114	0.118	0.122
E1	4.90 BSC			0.193 BSC		
e	0.65 BSC			0.026 BSC		
L	--	--	0.55	--	--	0.022
θ	0	--	7°	0	--	7°

- Note:
1. Controlling Dimension:MM
 2. Dimension D and E1 do not include Mold protrusion
 3. Refer to Jedec standard MO187
 4. Drawing is not to scale